



MBC
Cutting Tools



Siz Üretirken Biz Destek Oluyoruz
We support while you produce

Ürün Kataloğu - Product Catalogue

2019-2020

www.baydarlar.com



Siz üretirken biz destek oluyoruz
We support while you produce

Misyonumuz - Our Mission

► Misyonumuz - Our Mission

Sürdürülebilir kalkınmayı kendimize yol haritası kabul ederek; çevreye duyarlı, en az maliyetle, paydaşlarımızın isteklerini karşılayan bir şirket olmaktır.

To be a company which recognise sustainable development as a road map to us to meet the demands of our clients with environmentally sensitive with minimal cost.

Vizyonumuz - Our Vision

► Vizyonumuz - Our Vision

Toplam kalite felsefesi ile Dünya Sanayisi'ne güvenilir, kaliteli ürün ve hizmet vermektir.

Müşteri istek ve ihtiyaçlarını tam olarak anlamak ve karşılamak, kalite yönetim sistemimizin gelişimini ve etkinliğini sağlayarak iç ve dış pazarda rekabet gücümüzü arttırmak, sürekli gelişmek için tüm çalışanların eğitimini ve katılımını sağlamak, ürün kalitemizi arttırmak ve maliyetlerimizi düşürmek.

Sektörümüzdeki teknolojik gelişmeleri yakından takip etmek ve bu gelişmeleri her alanda uygulamak.

With the philosophy of total quality; serve the World Industrial Estate reliable and high quality products.

Understand exactly what the clients requests and needs, provide the development and effectiveness of our quality management system to increase our competitiveness in domestic and international market; to continuous development ensure the training and participation of all employees; improve the products quality and reduce the costs.

Follow the technological developments in our industry and implement these developments in all areas.



Siz üretirken biz destek oluyoruz
We support while you produce



- **DIŞ KANAL KATERLERİ**
EXTERNAL GROOVING
TOOLHOLDERS
Sayfa / Page : 9-15



- **ŞAFTLI TARAMALAR**
MILLING TOOLS
Sayfa / Page : 55-87



- **DIŞ KANAL KATERLERİ OTOMAT**
EXTERNAL GROOVING
TOOLHOLDERS AUTOMAT
Sayfa / Page : 16



- **ŞAFTLI TARAMALAR HIGH FEED**
MILLING TOOLS HIGH FEED
Sayfa / Page : 88-99



- **İÇ KANAL KATERLERİ**
INTERNAL GROOVING
TOOLHOLDERS
Sayfa / Page : 17-20



- **HIGH FEED FINISH TAKIMLARI**
HIGH FEED FINISH TOOLS
Sayfa / Page : 100-102



- **S-SİSTEM DIŞ ÇAP TORNALAMA KATERLERİ**
S-SYSTEM EXTERNAL TURNING
TOOLHOLDERS
Sayfa / Page : 21-29



- **FREZELEME TAKIMLARI**
FACE MILLING
Sayfa / Page : 103-106



- **C-SİSTEM DIŞ ÇAP TORNALAMA KATERLERİ**
C-SYSTEM EXTERNAL TURNING
TOOLHOLDERS
Sayfa / Page : 30-31



- **TARAMA KAFALARI**
FACE MILLING
Sayfa / Page : 107-143



- **T-SİSTEM DIŞ ÇAP TORNALAMA KATERLERİ**
T-SYSTEM EXTERNAL TURNING
TOOLHOLDERS
Sayfa / Page : 32-39



- **HIGH FEED TARAMA KAFALARI**
HIGH FEED MILLINGS
Sayfa / Page : 144-155



- **M-SİSTEM DIŞ ÇAP TORNALAMA KATERLERİ**
M-SYSTEM EXTERNAL TURNING
TOOLHOLDERS
Sayfa / Page : 40-41



- **VİDALI TARAMALAR**
SCREW TYPE
Sayfa / Page : 156-175



- **S-SİSTEM İÇ ÇAP TORNALAMA KATERLERİ**
S-SYSTEM INTERNAL TURNING
TOOLHOLDERS
Sayfa / Page : 42-47



- **U-DRILLER**
U-DRILLS
Sayfa / Page : 176-184



- **C-SİSTEM İÇ ÇAP TORNALAMA KATERLERİ**
C-SYSTEM INTERNAL TURNING
TOOLHOLDERS
Sayfa / Page : 48-49



- **KATERLER**
CUTTING TOOLS
Sayfa / Page : 185-187



- **T-SİSTEM İÇ ÇAP TORNALAMA KATERLERİ**
T-SYSTEM INTERNAL TURNING
TOOLHOLDERS
Sayfa / Page : 50-52



- **YEDEK PARÇALAR**
SPARE PARTS
Sayfa / Page : 188-191



- **M-SİSTEM İÇ ÇAP TORNALAMA KATERLERİ**
M-SYSTEM INTERNAL TURNING
TOOLHOLDERS
Sayfa / Page : 53-54



► **Takım Tipi / Tool Type**

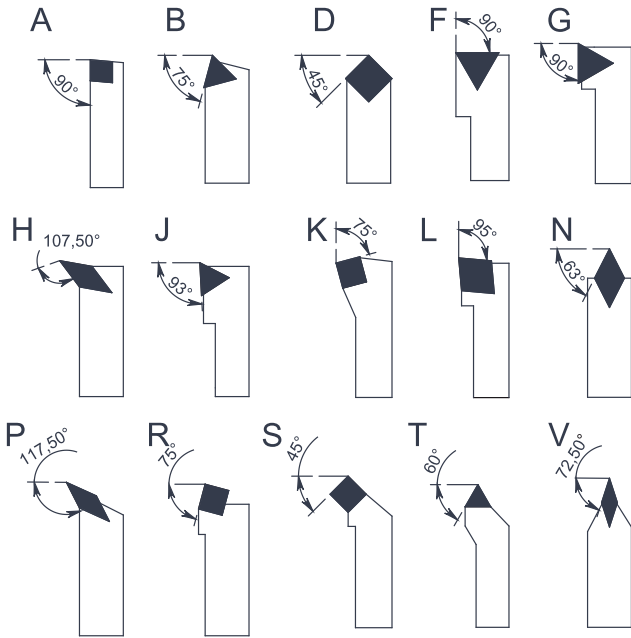

► **Kesme Yönü / Cutting Directions**

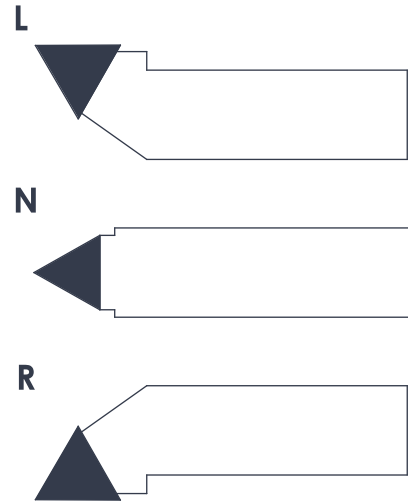

► **Uç Şekli / Insert Form**

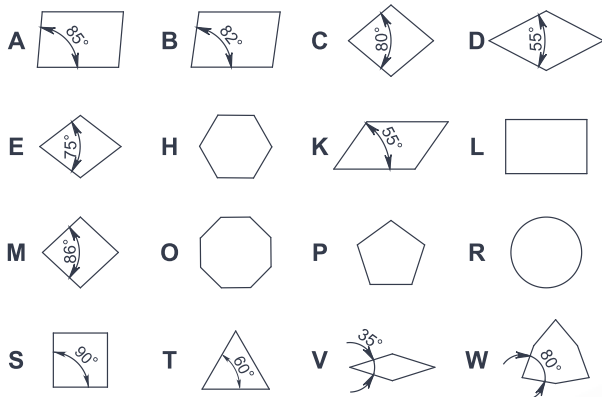

► **Uç Kenar Boşluk Açısı / Clearance Angle of Insert**

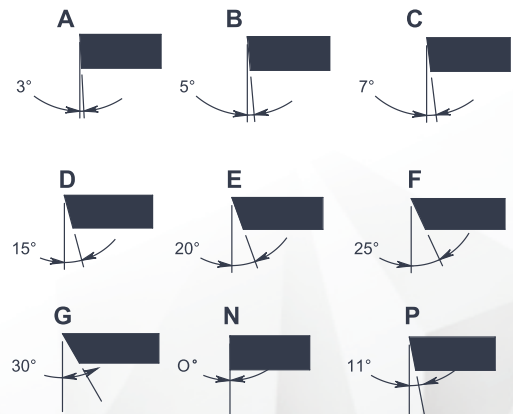

► **M Sistem / M System**

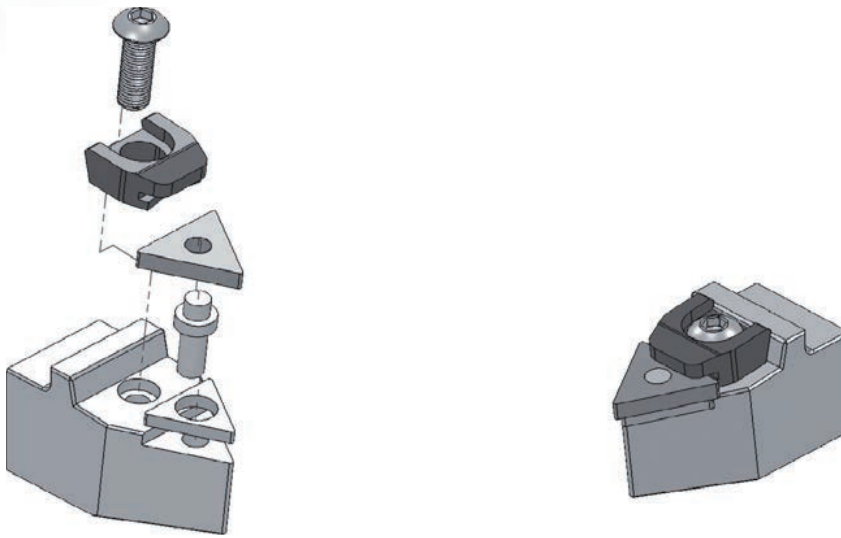



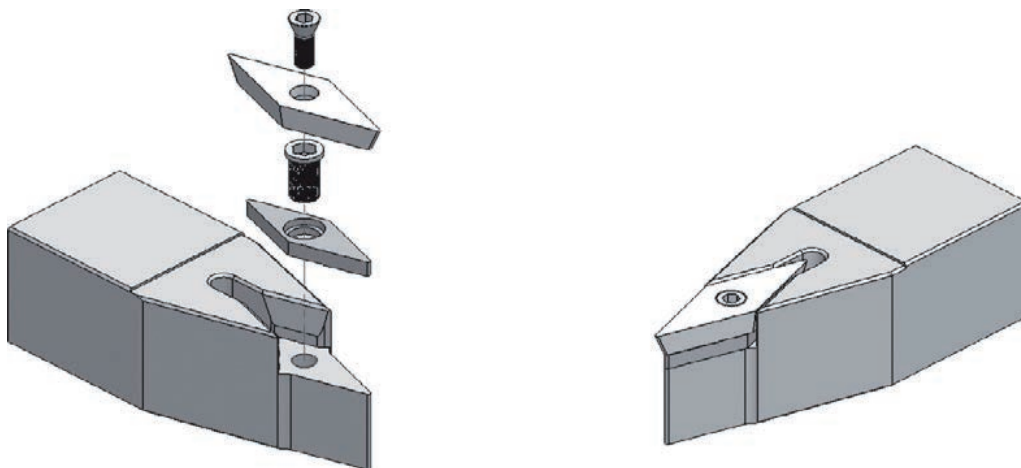

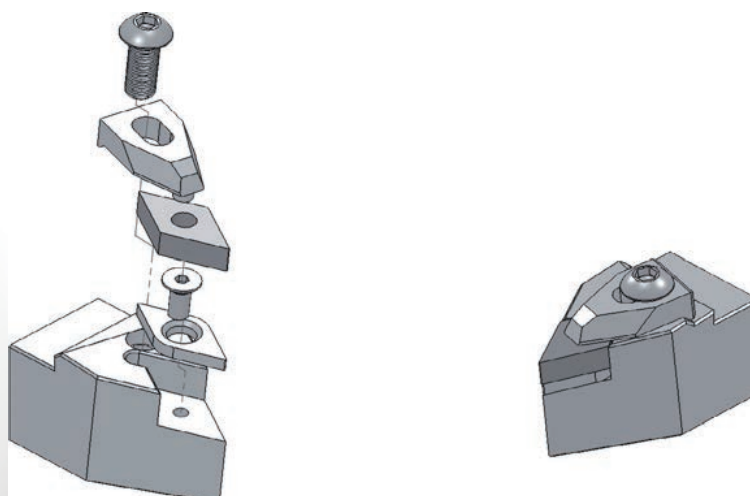

► **S Sistem / S System**

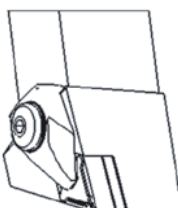
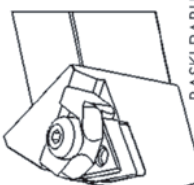

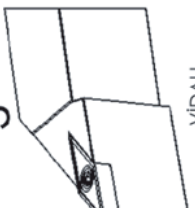
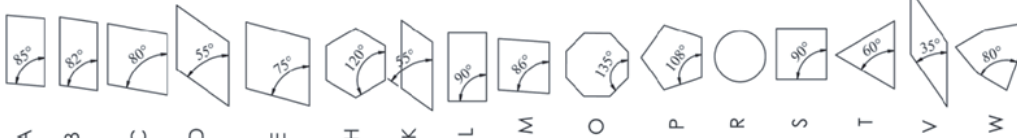
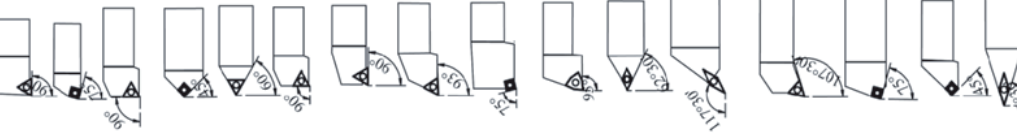
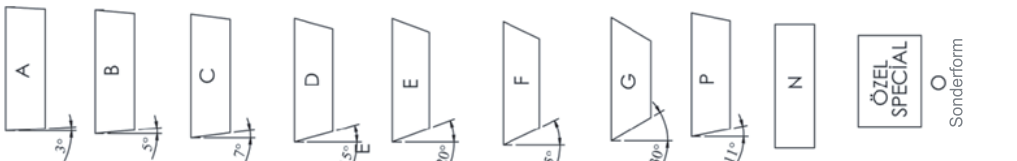
► **T Sistem / T System**

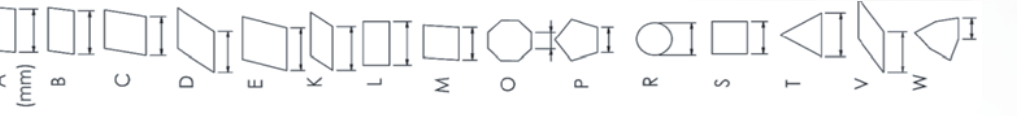

1	2	3	4	5	6	7	8	9
T	D	J	N	R	20	20	K	15
1	2	3	4	5	6	7	8	9
Uç Bağlama Sistemi Clamping System Klemmsystem	Kesici Uç Tipi Insert form WSP - Form	Kater Tipi Style Werkzeugtyp	Uç Açısı Clearance angle WSP - Freiwinkel	Kater Yönü Holder execution Bearbeitungsrichtung	Şaft Yüksekliği Height of shank Schaftquerschnitts	Şaft Genişliği Width of shank Schaftbreite	Takım Boyu Length of holder Werkzeuglänge	Uç Kenar Uzunluğu Length of cutting ed WSP-Größe
 ÇEKİRMELİ M  BAŞKI PABUÇLU P  LEVYELİ S  VIDALI								

7	
UÇ RADÜSÜ Chamfer or corner radius Planfase oder Eckenradius	
SEMBOLE	R
00	0
02	0.2
04	0.4
08	0.8
12	1.2
16	1.6
24	2.4
32	3.2

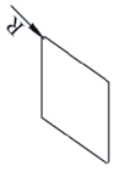

6	
UÇ KALINLIĞI Height of cutting edge Schneidkantenhöhe	
SEMBOLE	S
01	1.59
T1	1.98
02	2.38
T3	3.18
03	3.97
04	4.76
05	5.56
06	6.35
07	7.94
09	9.52

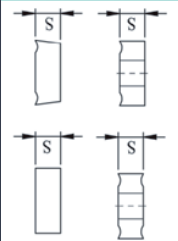

4	
KESİCİ UÇ DELİK TİPİ Type of insert Plattentyp	
N	R
F	A
M	G
W	T
Q	ÖZEL SPECIAL X

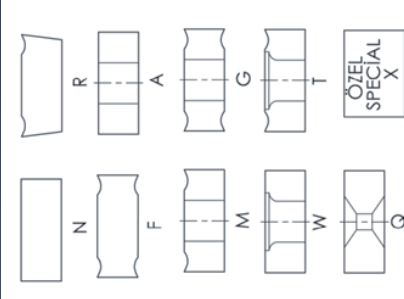

2	
UÇ AÇISI Clearance Angle Fräswinkel	
B	5°
C	7°
D	15°
E	20°
F	25°
P	11°
N	

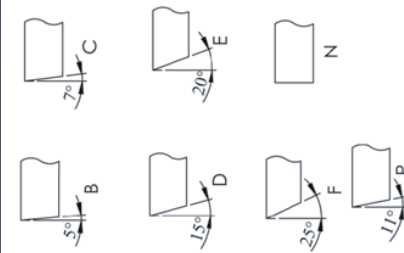

1	
KESİCİ UÇ TİPİ Shape Plattentform	
C	80°
D	55°
E	75°
K	5°
L	
S	
T	
V	35°
W	80°
R	

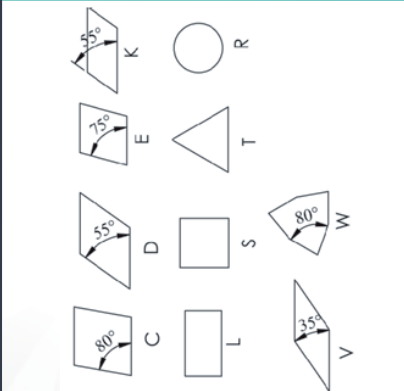

8 H R

5 15 06 08

4 G

3 M

2 N

1 D

8-9	
KESME KENARI ŞEKLİ Insert Forms WSP-Form	
UÇ FORMLARI Insert Forms WSP-Form	

5	
KESME KENARI UZUNLUĞU Length of Cutting edge Schneidenlänge	
C	S
D	T
W	
R	V

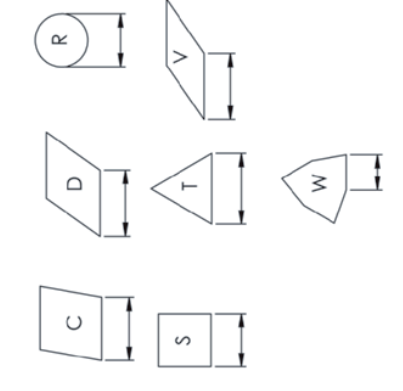

3	
UÇ TOLERANSLARI Tolerance Toleranz	
SEMBOLE Shape Plattentform	
A	m (±) 0.005
F	S (±) 0.025
C	d (±) 0.013
H	0.025
E	0.025
G	0.025
J	0.130
K	0.025
L	0.013
M	0.025
N	0.08 - 0.18
U	0.05 - 0.38



DIŞ KANAL KATERLERİ
EXTERNAL GROOVING TOOLHOLDERS



DIŞ KANAL KATERLERİ / EXTERNAL GROOVING TOOLHOLDERS



L: Sol /Left
R: Sağ /Right



✓ Stokta /In Stock
✗ Stokta Yok /Non Stock

Lütfen Sipariş vermeden önce stok durumunu sorunuz.
Please ask before ordering, stock status.

www.baydarlar.com

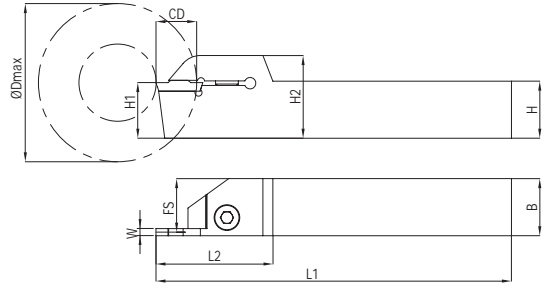

► DKT I

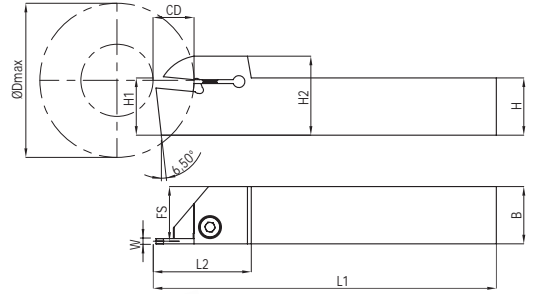

Kesici Uç Uyumluluğu Insert Suitability		Stok Stock												  			
DGN	R	L	Dmax	W	H	B	FS	L1	L2	H1	H2	CD	Uç Insert	Vida Screw	Anahtar Allen Key		
DKT I 001 DGN	✓	✓	62	2	12	12	11	90	31	12	24	16	DGN-2	M5X16	A4		
DKT I 002 DGN	✓	✓	62	2	16	16	15	125	43	16	28,5	16		M6X26			
DKT I 003 DGN	✓	✓	62	2	20	20	19	125	43	20	28,5	18		M5X16			
DKT I 004 DGN	✓	✓	62	2	25	25	24	150	47	25	35	22	DGN-3	M6X26			
DKT I 005 DGN	✓	✓	62	3	12	12	10,5	90	31	12	24	18				M5X16	
DKT I 006 DGN	✓	✓	62	3	16	16	14,5	125	43	16	28,5	18				M6X26	
DKT I 007 DGN	✓	✓	62	3	20	20	18,5	125	43	20	28,5	18	DGN-4			M6X26	
DKT I 008 DGN	✓	✓	62	3	25	25	23,5	150	47	25	35	22					M6X26
DKT I 009 DGN	✓	✓	62	3	32	32	30,5	170	47	32	42	22					M6X26
DKT I 010 DGN	✓	✓	62	4	16	16	14	125	43	16	28,5	18	DGN-5				M6X26
DKT I 011 DGN	✓	✓	62	4	20	20	18	125	43	20	28,5	18			M6X26		
DKT I 012 DGN	✓	✓	62	4	25	25	23	150	47	25	35	22			M6X26		
DKT I 013 DGN	✓	✓	62	4	32	32	30	170	47	32	42	22	DGN-6		M6X26		
DKT I 014 DGN	✓	✓	62	5	20	20	17,5	125	43	20	28,5	18		M6X26			
DKT I 015 DGN	✓	✓	62	5	25	25	22,5	150	47	25	35	22		M6X26			
DKT I 016 DGN	✓	✓	62	5	32	32	29,5	170	47	32	42	22	DGN-3	M6X26			
DKT I 017 DGN	✓	✓	62	6	25	25	22,5	150	47	25	35	22				M6X26	
DKT I 018 DGN	✓	✓	62	6	32	32	29,5	170	47	32	42	22				M6X26	
DKT I 019 DGN	✓	✓	62	3	25	25	23,5	150	47	25	35	40	DGN-4			M6X26	
DKT I 020 DGN	✓	✓	62	4	25	25	23	150	47	25	35	40					M6X26

► DKT H







Kesici Uç Uyumluluğu Insert Suitability		Stok Stock												  				
S229 HRN	R	L	Dmax	W	H	B	FS	L1	L2	H1	H2	CD	Uç Insert	Vida Screw	Anahtar Allen Key			
DKT H 001 S229	✓	✓	62	3	16	16	14,5	125	46	16	24	17	S229-3	M6X26	A4			
DKT H 002 S229	✓	✓	62	3	20	20	18,5	125	46	20	28,5	22				M6X26		
DKT H 003 S229	✓	✓	62	3	25	25	23,5	150	46	25	35	23				M6X26		
DKT H 004 S229	✓	✓	62	3	32	32	30,5	170	46	32	42	24	S229-4			M6X26		
DKT H 005 S229	✓	✓	62	4	20	20	18	125	46	20	28,5	22					M6X26	
DKT H 006 S229	✓	✓	62	4	25	25	23	150	46	25	35	23					M6X26	
DKT H 007 S229	✓	✓	62	4	32	32	30	170	46	32	42	24	S229-5				M6X26	
DKT H 008 S229	✓	✓	62	5	20	20	17,5	125	46	20	28,5	22						M6X26
DKT H 009 S229	✓	✓	62	5	25	25	22,5	150	46	25	35	23						M6X26
DKT H 010 S229	✓	✓	62	5	32	32	27,5	170	46	32	42	24	S229-6					M6X26
DKT H 011 S229	✓	✓	62	6	25	25	22	150	46	25	35	23		M6X26				

DIŞ KANAL KATERLERİ EXTERNAL GROOVING TOOLHOLDERS

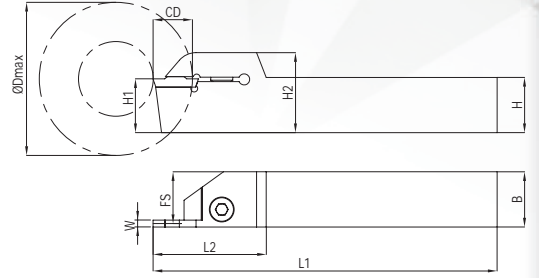





► DKT K

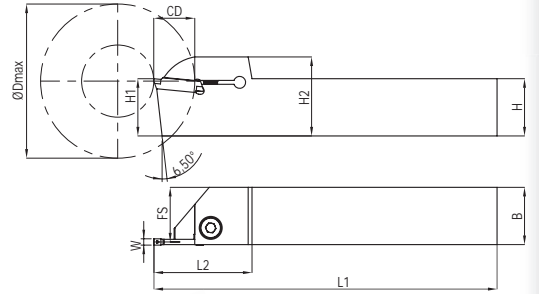

Kesici Uç Uyumluluğu Insert Suitability		Stok Stock												  		
MGM. KRLY	R	L	Dmax	W	H	B	FS	L1	L2	H1	H2	CD	Uç Insert	Vida Screw	Anahtar Allen Key	
DKT K 001 MGM.	✓	✓	62	2	12	12	11	90	31	12	24	16	MGM.2	M5x16	A4	
DKT K 002 MGM.	✓	✓	62	2	16	16	15	125	41	16	28,5	17		M6X26		
DKT K 003 MGM.	✓	✓	62	2	20	20	19	125	41	20	28,5	17				
DKT K 004 MGM.	✓	✓	62	2	25	25	24	150	45	25	35	18				
DKT K 005 MGM.	✓	✓	62	2	32	32	31	170	45	32	42	21	MGM.3	M5x16		
DKT K 006 MGM.	✓	✓	62	3	12	12	10,5	90	31	12	24	16				
DKT K 007 MGM.	✓	✓	62	3	16	16	14,5	125	41	16	28,5	21				
DKT K 008 MGM.	✓	✓	62	3	20	20	18,5	125	41	20	28,5	21				
DKT K 009 MGM.	✓	✓	62	3	25	25	23,5	150	45	25	35	21	MGM.4	M6X26		
DKT K 010 MGM.	✓	✓	62	3	32	32	30,5	170	45	32	42	22				
DKT K 011 MGM.	✓	✓	62	4	16	16	14	125	41	16	28,5	21				
DKT K 012 MGM.	✓	✓	62	4	20	20	18	125	41	20	28,5	21				
DKT K 013 MGM.	✓	✓	62	4	25	25	23	150	45	25	35	21	MGM.5		M6X26	
DKT K 014 MGM.	✓	✓	62	4	32	32	30	170	45	32	42	21				
DKT K 015 MGM.	✓	✓	62	5	20	20	17,5	125	41	20	28,5	21				
DKT K 016 MGM.	✓	✓	62	5	25	25	22,5	150	45	25	35	22				
DKT K 017 MGM.	✓	✓	62	5	32	32	29,5	170	45	32	42	22	MGM.6			M6X26
DKT K 018 MGM.	✓	✓	62	6	25	25	22	150	45	25	35	23				
DKT K 019 MGM.	✓	✓	62	6	32	32	29	170	45	32	42	23				
DKT K 023 MGM.	✓	✓	62	4	25	25	23	150	45	25	35	40		MGM.4		
DKT K 030 MGM.	✓	✓	62	3	25	25	23,5	150	45	25	35	40	MGM.3			

► DKT HK



Kesici Uç Uyumluluğu Insert Suitability		Stok Stock												  					
S224 HRN	R	L	Dmax	W	H	B	FS	L1	L2	H1	H2	CD	Uç Insert	Vida Screw	Anahtar Allen Key				
DKT HK 001 S224	✓	✓	62	2	16	16	15	125	43	16	28	18	S224-2	M6X26	A4				
DKT HK 002 S224	✓	✓	62	2	20	20	19	125	43	20	28	18							
DKT HK 003 S224	✓	✓	62	2	25	25	24	150	43	25	35	21							
DKT HK 004 S224	✓	✓	62	3	16	16	14,5	125	43	16	28	18							
DKT HK 005 S224	✓	✓	62	3	20	20	18,5	125	43	20	28	18	S224-3			M6X26	A4		
DKT HK 006 S224	✓	✓	62	3	25	25	23,5	150	43	25	35	21							
DKT HK 007 S224	✓	✓	62	3	32	32	30,5	170	46	32	42	24							
DKT HK 008 S224	✓	✓	62	4	16	16	14	125	43	16	28	18							
DKT HK 009 S224	✓	✓	62	4	20	20	18	125	43	20	28	18	S224-4					M6X26	A4
DKT HK 010 S224	✓	✓	62	4	25	25	23	150	43	25	35	21							
DKT HK 011 S224	✓	✓	62	4	32	32	30	170	46	32	42	24							

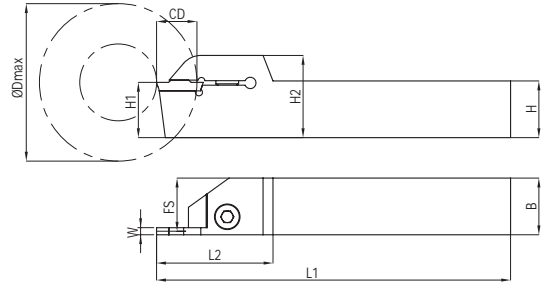

▶ DKT TT

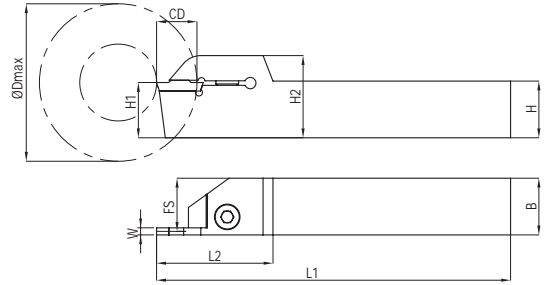

Kesici Uç Uyumluluğu Insert Suitability		Stok Stock												  		
TD.. TGTC	R	L	Dmax	W	H	B	FS	L1	L2	H1	H2	CD	Uç Insert	Vida Screw	Anahtar Allen Key	
DKT TT 001 TD..	✓	✓	62	2	12	12	11	90	31	12	24	16	TD.. 2	M5x16	A4	
DKT TT 002 TD..	✓	✓	62	2	16	16	15	125	41	16	28,5	17				
DKT TT 003 TD..	✓	✓	62	2	20	20	19	125	41	20	28,5	17				
DKT TT 004 TD..	✓	✓	62	2	25	25	24	150	45	25	35	18				
DKT TT 005 TD..	✓	✓	62	3	12	12	10,5	90	31	12	24	16	TD.. 3	M5x16		
DKT TT 006 TD..	✓	✓	62	3	16	16	14,5	125	41	16	28,5	21				
DKT TT 007 TD..	✓	✓	62	3	20	20	18,5	125	41	20	28,5	21				
DKT TT 008 TD..	✓	✓	62	3	25	25	23,5	150	45	25	35	21				
DKT TT 009 TD..	✓	✓	62	3	32	32	30,5	170	45	32	42	22				
DKT TT 010 TD..	✓	✓	62	4	16	16	14	125	41	16	28,5	21	TD.. 4	M6X26		
DKT TT 011 TD..	✓	✓	62	4	20	20	18	125	41	20	28,5	21				
DKT TT 012 TD..	✓	✓	62	4	25	25	23	150	45	25	35	21				
DKT TT 013 TD..	✓	✓	62	4	32	32	30	170	45	32	42	21				
DKT TT 014 TD..	✓	✓	62	5	25	25	22,5	150	45	25	35	21	TD.. 5			

▶ DKT ZCC2

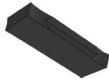





Kesici Uç Uyumluluğu Insert Suitability		Stok Stock												  		
ZCC ZT.D	R	L	Dmax	W	H	B	FS	L1	L2	H1	H2	CD	Uç Insert	Vida Screw	Anahtar Allen Key	
DKT ZCC2 001 ZT.D	✓	✓	62	2	20	20	19	125	41	20	28,5	17	ZT.D 2	M6X26	A4	
DKT ZCC2 002 ZT.D	✓	✓	62	2	25	25	24	150	45	25	35	21				
DKT ZCC2 003 ZT.D	✓	✓	62	2,5	16	16	14,75	125	41	16	24,5	17	ZT.D 2,5			
DKT ZCC2 004 ZT.D	✓	✓	62	2,5	20	20	18,75	125	41	20	28,5	17				
DKT ZCC2 005 ZT.D	✓	✓	62	2,5	25	25	23,75	150	45	25	35	21	ZT.D 3			
DKT ZCC2 006 ZT.D	✓	✓	62	3	16	16	14,5	125	41	16	24,5	21				
DKT ZCC2 007 ZT.D	✓	✓	62	3	20	20	18,5	125	41	20	28,5	21				
DKT ZCC2 008 ZT.D	✓	✓	62	3	25	25	23,5	150	45	25	35	21				
DKT ZCC2 009 ZT.D	✓	✓	62	4	16	16	14	125	41	16	24,5	21	ZT.D 4			
DKT ZCC2 010 ZT.D	✓	✓	62	4	20	20	18	125	41	20	28,5	21				
DKT ZCC2 011 ZT.D	✓	✓	62	4	25	25	23	150	45	25	35	21				
DKT ZCC2 012 ZT.D	✓	✓	62	4	32	32	30	170	45	32	42	23	ZT.D 5			
DKT ZCC2 013 ZT.D	✓	✓	62	5	16	16	13,5	125	41	16	24,5	21				
DKT ZCC2 014 ZT.D	✓	✓	62	5	20	20	17,5	125	41	20	28,5	21				
DKT ZCC2 015 ZT.D	✓	✓	62	5	25	25	22,5	150	45	25	35	21	ZT.D 6			
DKT ZCC2 016 ZT.D	✓	✓	62	5	32	32	29,5	170	45	32	42	23				
DKT ZCC2 017 ZT.D	✓	✓	62	6	20	20	17	125	41	20	28,5	21	ZT.D 2,5			
DKT ZCC2 018 ZT.D	✓	✓	62	6	25	25	22	150	45	25	35	21				
DKT ZCC2 019 ZT.D	✓	✓	62	6	32	32	29	170	45	32	42	23				
DKT ZCC2 020 ZT.D	✓	✓	62	2,5	20	20	18,75	125	41	20	28,5	22				

DIŞ KANAL KATERLERİ EXTERNAL GROOVING TOOLHOLDERS

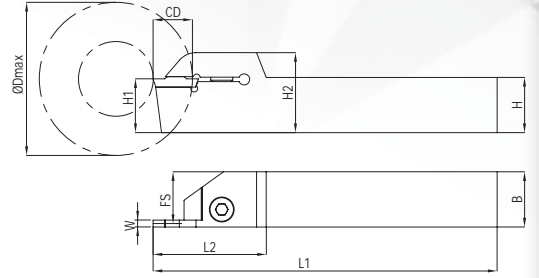





► DKT KYC

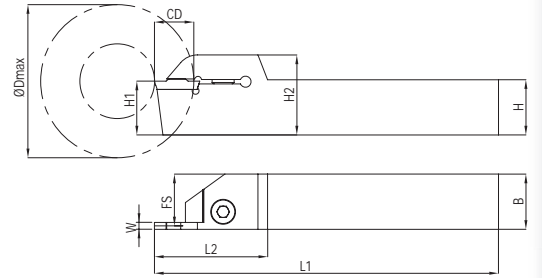

Kesici Uç Uyumluluğu Insert Suitability		Stok Stock												  		
KYC-GDM	R	L	Dmax	W	H	B	FS	L1	L2	H1	H2	CD	Uç Insert	Vida Screw	Anahtar Allen Key	
DKT KY 001 GDM	✓	✓	62	2	12	12	11	125	41	12	20,5	17	GDM.2	M6X26	A4	
DKT KY 002 GDM	✓	✓	62	2	16	16	15	125	41	16	24,5	17				
DKT KY 003 GDM	✓	✓	62	2	20	20	19	125	41	20	28,5	17				
DKT KY 004 GDM	✓	✓	62	2	25	25	24	150	45	25	35	18	GDM.3			
DKT KY 005 GDM	✓	✓	62	3	12	12	10,5	125	41	12	20,5	17				
DKT KY 006 GDM	✓	✓	62	2	16	16	15	125	41	16	24,5	17				
DKT KY 007 GDM	✓	✓	62	3	20	20	18,5	125	43	20	28,5	18	GDM.4			
DKT KY 008 GDM	✓	✓	62	3	25	25	23,5	150	45	25	35	21				
DKT KY 009 GDM	✓	✓	62	4	16	16	15	125	41	16	24,5	17	GDM.2			
DKT KY 010 GDM	✓	✓	62	2	20	20	19	125	41	20	28,5	17				
DKT KY 011 GDM	✓	✓	62	2	25	25	24	150	45	25	35	10	GDM.3			
DKT KY 012 GDM	✓	✓	62	3	25	25	23,5	150	45	25	35	25				
DKT KY 013 GDM	✓	✓	62	4	25	25	23	150	45	25	35	25	GDM.4			

► DKT SND



Kesici Uç Uyumluluğu Insert Suitability		Stok Stock												  		
ZCC Z.T.D	R	L	Dmax	W	H	B	FS	L1	L2	H1	H2	CD	Uç Insert	Vida Screw	Anahtar Allen Key	
DKT SND 004 N123	✓	✓	62	2	25	25	24	150	45	25	35	21	N123-2C	M6X26	A4	
DKT SND 007 N123	✓	✓	62	3	20	20	18,5	125	41	20	28,5	21	N123-3C			
DKT SND 008 N123	✓	✓	62	3	25	25	23,5	150	45	25	35	21				
DKT SND 011 N123	✓	✓	62	4	20	20	18	125	41	20	28,5	21	N123-4C			
DKT SND 012 N123	✓	✓	62	4	25	25	23	150	45	25	35	21				
DKT SND 014 N123	✓	✓	62	5	20	20	17,5	125	41	20	28,5	21	N123-5C			
DKT SND 015 N123	✓	✓	62	5	25	25	22,5	150	45	25	35	21				
DKT SND 016 N123	✓	✓	62	5	32	32	29,5	170	45	32	42	23	N123-1,5C			
DKT SND 019 N123	✓	✓	62	1,5	25	25	24,25	150	45	25	35	21				

► DKT H360

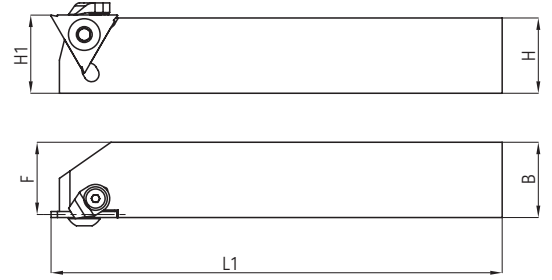

Kesici Uç Uyumluluğu Insert Suitability		Stok Stock		H1	B	F	L1	L2	λS	Y0	Uç Insert	Vida Screw	Pabuç Clamp	Vida Screw	Anahtar Torx Key	Anahtar Allen Key
HRN S312																
DKT H 360 001 S312	✓			16	16	15,5	125	-	0	0	S312-1	M5X12 A3	C110105	M4X10	T15	A3
DKT H 360 002 S312	✓			20	20	19,5	125	-	0	0	S312-1					
DKT H 360 003 S312	✓			25	25	24,5	150	-	0	0	S312-1					
DKT H 360 004 S312	✓			16	16	15	125	-	0	0	S312-2					
DKT H 360 005 S312	✓			20	20	19	125	-	0	0	S312-2					
DKT H 360 006 S312	✓			25	25	24	150	-	0	0	S312-2					
DKT H 360 007 S312	✓			16	16	14,5	125	-	0	0	S312-3					
DKT H 360 008 S312	✓			20	20	18,5	125	-	0	0	S312-3					
DKT H 360 009 S312	✓			25	25	23,5	150	-	0	0	S312-3					

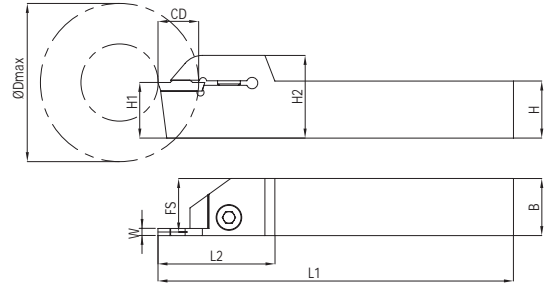

► DKT LMN





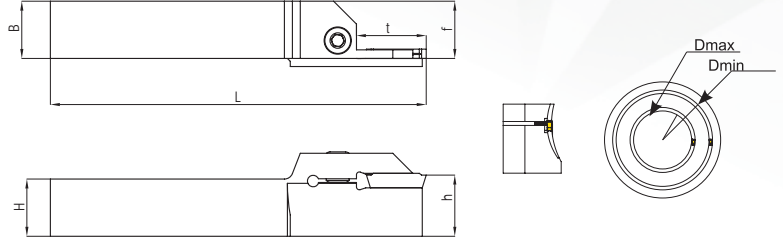

Kesici Uç Uyumluluğu Insert Suitability		Stok Stock		Dmax	W	H	B	FS	L1	L2	H1	H2	CD	Uç Insert	Vida Screw	Anahtar Allen Key
LMN GCX	R	L														
DKT LMN 001 GCX	✓	✓		62	2	12	12	11	90	31	12	24	16	GCX-2	M5X16	A4
DKT LMN 002 GCX	✓	✓		62	2	16	16	15	125	43	16	28,5	16		M6X26	
DKT LMN 003 GCX	✓	✓		62	2	20	20	19	125	43	20	28,5	18			
DKT LMN 004 GCX	✓	✓		62	2	25	25	24	150	47	25	35	22	GCX-3	M5X16	
DKT LMN 005 GCX	✓	✓		62	3	12	12	10,5	90	31	12	24	18		M6X26	
DKT LMN 006 GCX	✓	✓		62	3	16	16	14,5	125	43	16	28,5	18			
DKT LMN 007 GCX	✓	✓		62	3	20	20	18,5	125	43	20	28,5	18	GCX-4	M6X26	
DKT LMN 008 GCX	✓	✓		62	3	25	25	23,5	150	47	25	35	22			
DKT LMN 009 GCX	✓	✓		62	3	32	32	30,5	170	47	32	42	22			
DKT LMN 010 GCX	✓	✓		62	4	16	16	14	125	43	16	28,5	18	GCX-4	M6X26	
DKT LMN 011 GCX	✓	✓		62	4	20	20	18	125	43	20	28,5	18			
DKT LMN 012 GCX	✓	✓		62	4	25	25	23	150	47	25	35	22			
DKT LMN 013 GCX	✓	✓		62	4	32	32	30	170	47	32	42	22			

► ALIN KANAL KATERİ

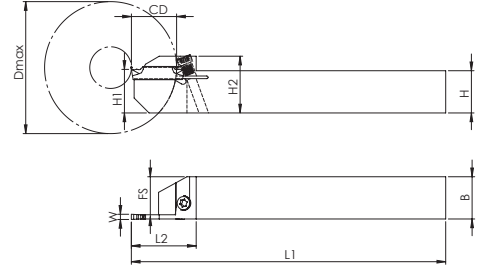

Kesici Uç Uyumluluğu Insert Suitability		Stok Stock												
KRLY MGM	R	L	Dmin	Dmax	H	B	f	L1	h	t max	Uç Insert	Vida Screw	Anahtar Allen Key	
AKT K 001 MGM.	✓	X	30	40	25	25	26,7	150	25	17,5	KRLY MGM. 300	M6x26 A4	A4	
AKT K 002 MGM.	✓	X	35	50	25	25	26,7	150	25	17,5				
AKT K 003 MGM.	✓	X	45	70	25	25	26,7	150	25	17,5				
AKT K 004 MGM.	✓	X	65	105	25	25	26,7	150	25	17,5				
AKT K 005 MGM.	✓	X	100	150	25	25	26,7	150	25	17,5				
AKT K 006 MGM.	✓	X	30	40	25	25	26,8	150	25	17,5	KRLY MGM. 400			
AKT K 007 MGM.	✓	X	35	50	25	25	26,8	150	25	17,5				
AKT K 008 MGM.	✓	X	45	70	25	25	26,8	150	25	17,5				
AKT K 009 MGM.	✓	X	65	105	25	25	26,8	150	25	17,5				
AKT K 010 MGM.	✓	X	100	150	25	25	26,8	150	25	17,5	KRLY MGM. 500			
AKT K 011 MGM.	✓	X	75	110	25	25	27	150	25	17,5				
AKT K 012 MGM.	✓	X	105	150	25	25	27	150	25	17,5				
AKT K 013 MGM.	✓	X	145	200	25	25	27	150	25	17,5				

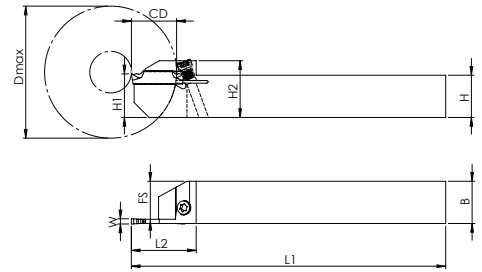

► DKT I OTOMAT

Kesici Uç Uyumluluğu Insert Suitability		Stok Stock												  		
DGN	R	L	Dmax	W	H	B	FS	L1	L2	H1	H2	CD	Uç Insert	Vida Screw	Anahtar Allen Key	
DKT I 001 DGN OT	✓	✓	50	1,5	10	10	9,25	125	30	10	21	17	DGN-1,5	M4	A4	
DKT I 002 DGN OT	✓	✓	50	1,5	12	12	11,25	125	30	12	21	17				
DKT I 003 DGN OT	✓	✓	50	1,5	16	16	15,25	125	30	16	21	17				
DKT I 004 DGN OT	✓	✓	50	2	12	12	11	125	30	12	21	17	DGN-2	M4	A4	
DKT I 005 DGN OT	✓	✓	50	3	12	12	10,5	125	30	12	21	17	DGN-3			
DKT I 006 DGN OT	✓	✓	50	3	16	16	14,5	125	30	16	21	17	DGN-3			

► DKT KYC OTOMAT

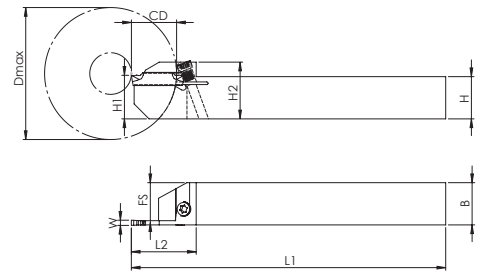
Kesici Uç Uyumluluğu Insert Suitability		Stok Stock												  		
KYC-GDM	R	L	Dmax	W	H	B	FS	L1	L2	H1	H2	CD	Uç Insert	Vida Screw	Anahtar Allen Key	
DKT KY 001 GDM OT	✓	✓	50	2	10	10	9	125	30	10	21	17	GDM.2	M4	A4	
DKT KY 002 GDM OT	✓	✓	50	2	12	12	11	125	30	12	21	17				
DKT KY 003 GDM OT	✓	✓	50	2	16	16	15	125	30	16	21	17				
DKT KY 004 GDM OT	✓	✓	50	3	12	12	10,5	125	30	12	21	17	GDM.3	M4	A4	
DKT KY 005 GDM OT	✓	✓	50	3	16	16	14,5	125	30	16	21	17	GDM.3			

► DKT SND OTOMAT

Kesici Uç Uyumluluğu Insert Suitability		Stok Stock												  		
SND N123	R	L	Dmax	W	H	B	FS	L1	L2	H1	H2	CD	Uç Insert	Vida Screw	Anahtar Allen Key	
DKT SND 001 N123 OT	✓	✓	50	1,5	12	12	11,25	125	30	12	21	17	N123-1,5C	M4	A4	
DKT SND 002 N123 OT	✓	✓	50	1,5	16	16	15,25	125	30	16	21	17				
DKT SND 003 N123 OT	✓	✓	50	2	12	12	11,25	125	30	12	21	17				
DKT SND 004 N123 OT	✓	✓	50	3	12	12	11,25	125	30	12	21	17	N123-3C	M4	A4	

İÇ KANAL KATERLERİ
INTERNAL GROOVING TOOLHOLDERS



İÇ KANAL KATERLERİ / INTERNAL GROOVING TOOLHOLDERS



L: Sol / Left
R: Sağ / Right

✓ Stokta / In Stock
✗ Stokta Yok / Non Stock

Lütfen Sipariş vermeden önce stok durumunu sorunuz.
Please ask before ordering, stock status.

www.baydarlar.com

► IKT K

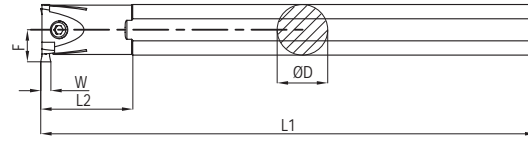

Kesici Uç Uyumluluğu Insert Suitability	Stok Stock	D	D min	F	L1	L2	W	Uç Insert	Vida Screw	Anahtar Allen Key
MGM KRLY										
IKT K 001 MGM	✓	16	20	12	180	25	2	MGM.-2	M4X12	A3
IKT K 002 MGM	✓	20	25	14	200	30	2			
IKT K 003 MGM	✓	25	31	18	250	35	2			
IKT K 004 MGM	✓	32	39	22	250	30	2			
IKT K 005 MGM	✓	20	25	14,5	200	30	3	MGM.-3	M6X16	A5
IKT K 006 MGM	✓	25	32	18,5	250	35	3			
IKT K 007 MGM	✓	32	42	25	250	35	3			
IKT K 008 MGM	✓	20	25	14,5	200	30	4	MGM.-4		
IKT K 009 MGM	✓	25	32	18,5	250	30	4			
IKT K 010 MGM	✓	32	42	25	250	35	4			
IKT K 011 MGM	✓	40	52	30	400	60	3	MGM.-3		
IKT K 012 MGM	✓	40	52	30	400	60	4	MGM.-4		
IKT K 013 MGM	✓	40	52	30	400	60	5	MGM.-5		
IKT K 014 MGM	✓	32	42	25	250	35	5			
IKT K 015 MGM	✓	25	32	18,5	250	30	5			

► IKT I

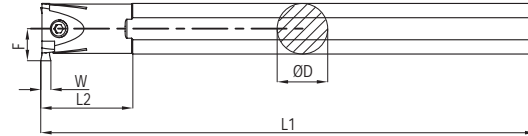

Kesici Uç Uyumluluğu Insert Suitability	Stok Stock	D	D min	F	L1	L2	W	Uç Insert	Vida Screw	Anahtar Allen Key
DGN.										
IKT I 000 DGN.	✓	16	20	12	180	25	1,5	DGN-1.5	M4X12	A3
IKT I 001 DGN.	✓	20	25	14	200	30	2	DGN-2		
IKT I 002 DGN.	✓	25	32	18,5	250	40	2		DGN-3	M6X16
IKT I 003 DGN.	✓	32	41	24,5	250	45	2	DGN-4		M4X12
IKT I 004 DGN.	✓	20	25	14	200	30	3		DGN-4	M6X16
IKT I 005 DGN.	✓	25	32	18,5	250	40	3	DGN-4		M4X12
IKT I 006 DGN.	✓	32	41	24,5	250	45	3		DGN-4	M6X16
IKT I 007 DGN.	✓	20	25	14	200	30	4	DGN-4		M4X12
IKT I 008 DGN.	✓	25	32	18,5	250	40	4		DGN-4	M6X16
IKT I 009 DGN.	✓	32	41	24,5	350	45	4			

► IKT HK

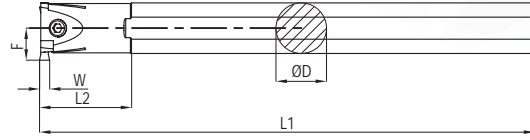

Kesici Uç Uyumluluğu Insert Suitability	Stok Stock	D	D min	F	L1	L2	W	Uç Insert	Vida Screw	Anahtar Allen Key
HRN S224										
IKT HK 001 S224	✓	20	25	14	200	30	2	S224-2	M4X12	A3
IKT HK 002 S224	✓	25	33	19	250	40	2		M6X16	A5
IKT HK 003 S224	✓	32	40	23	250	45	2		M4X12	A3
IKT HK 004 S224	✓	20	25	14	200	30	3	S224-3	M4X12	A3
IKT HK 005 S224	✓	25	33	19	250	40	3		M6X16	A5
IKT HK 006 S224	✓	32	40	23	250	45	3		M4X12	A3
IKT HK 007 S224	✓	20	25	14	200	30	4	S224-4	M4X12	A3
IKT HK 008 S224	✓	25	33	19	250	40	4		M6X16	A5
IKT HK 009 S224	✓	32	40	23	250	45	4		M6X16	A5

► IKT H

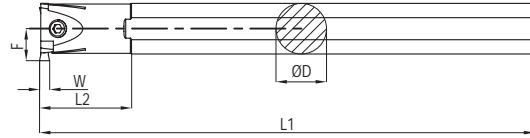

Kesici Uç Uyumluluğu Insert Suitability	Stok Stock	D	D min	F	L1	L2	W	Uç Insert	Vida Screw	Anahtar Allen Key
HRN S229										
IKT H 001 S229	✓	25	34	20,5	250	40	3	S229-3	M6X16	A5
IKT H 002 S229	✓	32	43	26	250	45	3			
IKT H 003 S229	✓	40	52	30	400	60	3			
IKT H 004 S229	✓	25	34	20,5	250	40	4	S229-4		
IKT H 005 S229	✓	32	43	26	250	45	4			
IKT H 006 S229	✓	40	52	30	400	60	4			
IKT H 007 S229	✓	25	34	20,5	250	40	5	S229-5		
IKT H 008 S229	✓	32	43	26	250	45	5			
IKT H 009 S229	✓	40	52	30	400	60	5			

► IKT ZCC2

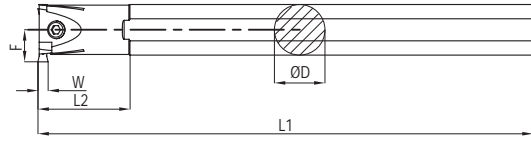

Kesici Uç Uyumluluğu Insert Suitability	Stok Stock	D	D min	F	L1	L2	W	Uç Insert	Vida Screw	Anahtar Allen Key
ZCC ZT.D										
IKT ZCC2 001 ZT.D	✓	20	25	14,5	200	30	3	ZT.D-3	M4X12	A3
IKT ZCC2 002 ZT.D	✓	25	32	18,5	250	35	3			
IKT ZCC2 003 ZT.D	✓	32	42	25	250	35	3			
IKT ZCC2 004 ZT.D	✓	25	32	18,5	250	30	4	ZT.D-4	M6X16	A5
IKT ZCC2 005 ZT.D	✓	32	42	25	250	35	4	ZT.D-5		
IKT ZCC2 006 ZT.D	✓	32	42	25	250	35	5	ZT.D-5		
IKT ZCC2 007 ZT.D	✓	40	52	30	400	60	5	ZT.D-5	M4X12	A3
IKT ZCC2 008 ZT.D	✓	25	32	18,5	250	35	2	ZT.D-2		
IKT ZCC2 009 ZT.D	✓	16	20	12	180	25	2	ZT.D-2		
IKT ZCC2 010 ZT.D	✓	20	25	14,5	200	30	2	ZT.D-2	M4X12	A3

► IKT SND

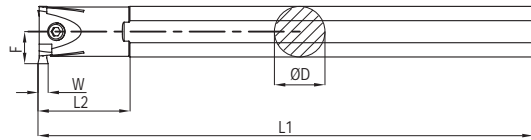

Kesici Uç Uyumluluğu Insert Suitability	Stok Stock	D	D min	F	L1	L2	W	Uç Insert	Vida Screw	Anahtar Allen Key
SND ZCC										
IKT SND 001 N123	✓	20	25	14,5	200	30	3	N123-3C	M6X16	A5
IKT SND 002 N123	✓	25	32	18,5	250	35	3			
IKT SND 003 N123	✓	32	42	25	250	35	3			
IKT SND 004 N123	✓	25	32	18,5	250	30	4	N123-4C	M6X16	A5
IKT SND 005 N123	✓	32	42	25	250	35	4			

S-SİSTEM DIŞ ÇAP TORNALAMA KATERLERİ
S-SYSTEM EXTERNAL TURNING TOOLHOLDERS



S-SİSTEM DIŞ ÇAP TORNALAMA KATERLERİ / S-SYSTEM EXTERNAL TURNING TOOLHOLDERS







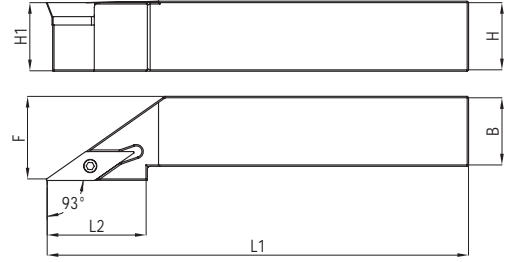

L: Sol / Left
R: Sağ / Right

✓ Stokta / In Stock
✗ Stokta Yok / Non Stock





Lütfen Sipariş vermeden önce stok durumunu sorunuz.
Please ask before ordering, stock status.

www.baydarlar.com

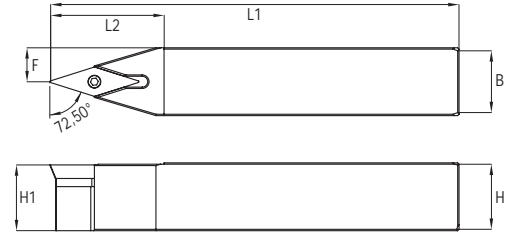
► SVJBR ISO





Kesici Uç Uyumluluğu Insert Suitability		Stok Stock												
ISO	R	L	H1 H	B	F	L1	L2	λS	Y0	Uç Insert	Altılık Shim	Vida Screw	Vida Screw	Anahtar Torx Key
SVJBR 001 ISO	✓	✓	12	12	20	100	20	0	0	VBM. 1103..	-	-	M2,5X7	T08
SVJBR 002 ISO	✓	✓	16	16	20	100	25	0	0		-	-	M2,5X7	T08
SVJBR 003 ISO	✓	✓	16	16	20	100	25	0	0	VBM. 1604..	-	-	M3,5X11	T15
SVJBR 004 ISO	✓	✓	20	20	25	125	35	0	0	VBM. 1103..	-	-	M2,5X7	T08
SVJBR 005 ISO	✓	✓	20	20	25	125	35	0	0	VBM. 1604..	VB..016	M5X0.5XM3.5	M3,5X14	T15
SVJBR 006 ISO	✓	✓	25	25	32	150	40	0	0					
SVJBR 007 ISO	✓	✓	32	32	40	170	40	0	0	VBM. 1103..	-	-	M2,5X7	T08
SVJBR 008 ISO	✓	✓	25	25	32	150	40	0	0					

► SVVBN ISO

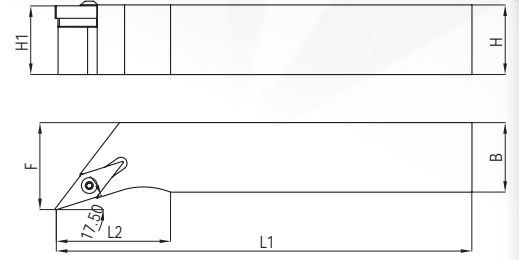
Kesici Uç Uyumluluğu Insert Suitability		Stok Stock												
ISO	R	L	H1 H	B	F	L1	L2	λS	Y0	Uç Insert	Altılık Shim	Vida Screw	Vida Screw	Anahtar Torx Key
SVVBN 001 ISO	✓		12	12	6	100	20	0	0	VBM. 1103..			M2,5X7	T08
SVVBN 002 ISO	✓		16	16	8	100	25	0	0				M2,5X7	T08
SVVBN 003 ISO	✓		20	20	10	125	35	0	0				M2,5X7	T08
SVVBN 004 ISO	✓		16	16	8	100	25	0	0	VBM. 1604..	VB..016	M5X0.5XM3.5	M3,5X11	T15
SVVBN 006 ISO	✓		20	20	10	125	35	0	0					
SVVBN 007 ISO	✓		25	25	12,5	150	40	0	0					
SVVBN 008 ISO	✓		32	32	16	170	40	0	0					





► SVHBR ISO

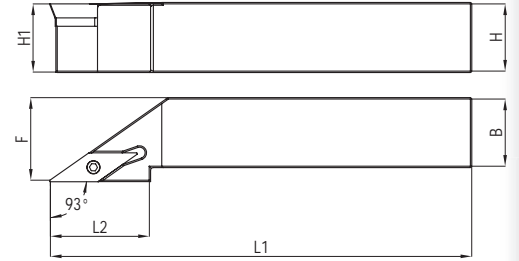

Kesici Uç Uyumluluğu Insert Suitability		Stok Stock												
ISO	R	L	H1 H	B	F	L1	L2	λS	Y0	Uç Insert	Altık Shim	Vida Screw	Vida Screw	Anahtar Torx Key
SVHBR 000 ISO	✓	✓	12	12	20	100	25	0	0	VBM. 1103..	-	-	M2,5X7	T08
SVHBR 001 ISO	✓	✓	16	16	20	100	25	0	0		-	-		
SVHBR 002 ISO	✓	✓	20	20	25	125	30	0	0		-	-		
SVHBR 003 ISO	✓	✓	20	20	25	125	35	0	0	VBM. 1604..	VB..016	M5X0.5XM3.5	M3,5X14	T15
SVHBR 004 ISO	✓	✓	25	25	32	150	40	0	0					
SVHBR 005 ISO	✓	✓	32	32	40	170	40	0	0					

► SVJCR ISO

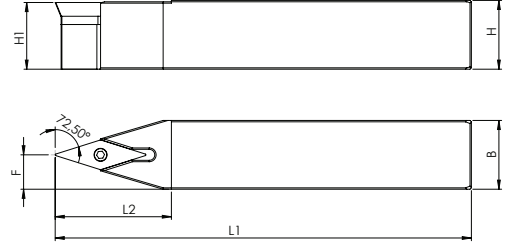

Kesici Uç Uyumluluğu Insert Suitability		Stok Stock												
ISO	R	L	H1 H	B	F	L1	L2	λS	Y0	Uç Insert	Altık Shim	Vida Screw	Vida Screw	Anahtar Torx Key
SVJCR 001 ISO	✓	✓	12	12	20	100	20	0	0	VC.T 1103..			M2,5X7	T08
SVJCR 002 ISO	✓	✓	16	16	20	100	25	0	0					
SVJCR 003 ISO	✓	✓	16	16	20	100	25	0	0	VC.T 1604..			M3,5X11	T15
SVJCR 004 ISO	✓	✓	20	20	25	125	35	0	0	VC.T 1103..			M2,5X7	T08
SVJCR 005 ISO	✓	✓	20	20	25	125	35	0	0	VC.T 1604..	VC..016	M5X0.5XM3.5	M3,5X14	T15
SVJCR 006 ISO	✓	✓	25	25	32	150	40	0	0					
SVJCR 007 ISO	✓	✓	32	32	40	170	40	0	0					

► SVVCN ISO





Kesici Uç Uyumluluğu Insert Suitability	Stok Stock	H1	H	B	F	L1	L2	λS	Y0	Uç Insert	Altılık Shim	Vida Screw	Vida Screw	Anahtar Torx Key
ISO														
SVVCN 001 ISO	✓	12	12	6	6	100	20	0	0	VC.T 1103..			M2,5X7	T08
SVVCN 002 ISO	✓	16	16	8	8	100	25	0	0					
SVVCN 003 ISO	✓	20	20	10	10	125	35	0	0					
SVVCN 004 ISO	✓	16	16	8	8	100	25	0	0	VC.T 1604..			M3,5X11	T15
SVVCN 005 ISO	✓	20	20	10	10	125	35	0	0		VB..016	M5X0.5XM3.5	M3,5X14	
SVVCN 006 ISO	✓	25	25	12,5	12,5	150	40	0	0					
SVVCN 007 ISO	✓	32	32	16	16	170	40	0	0					

► SDNCN ISO

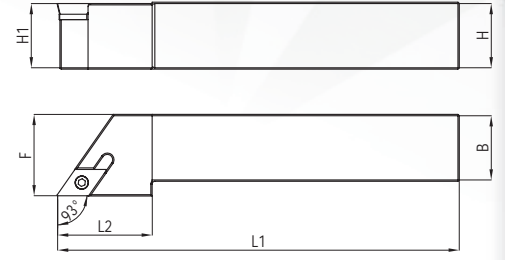

Kesici Uç Uyumluluğu Insert Suitability	Stok Stock	H1	H	B	F	L1	L2	λS	Y0	Uç Insert	Altılık Shim	Vida Screw	Vida Screw	Anahtar Torx Key	
ISO															
SDNCN 001 ISO	✓	8	8	4	4	100	16	0	0	DC.T 0702..			M2,5X7	T08	
SDNCN 002 ISO	✓	10	10	5	5	100	16	0	0						
SDNCN 003 ISO	✓	12	12	6	6	100	20	0	0						
SDNCN 004 ISO	✓	16	16	8	8	100	25	0	0						
SDNCN 005 ISO	✓	16	16	8	8	100	25	0	0	DC.T 11T3..	DC..011	M5X0.5XM3.5	M3,5X14	T15	
SDNCN 006 ISO	✓	20	20	10	10	125	35	0	0						
SDNCN 007 ISO	✓	25	25	12,5	12,5	150	40	0	0						
SDNCN 008 ISO	✓	32	32	16	16	170	40	0	0						
SDNCN 009 ISO	✓	12	12	6	6	100	20	0	0						





► SDJCR ISO

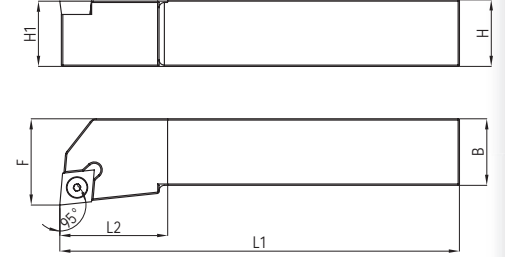



Kesici Uç Uyumluluğu Insert Suitability		Stok Stock												
ISO	R	L	H1 H	B	F	L1	L2	λS	Y0	Uç Insert	Altık Shim	Vida Screw	Vida Screw	Anahtar Torx Key
SDJCR 001 ISO	✓	✓	8	8	10	100	16	0	0	DC.T 0702..			M2,5X7	T08
SDJCR 002 ISO	✓	✓	10	10	12	100	16	0	0					
SDJCR 003 ISO	✓	✓	12	12	16	100	20	0	0					
SDJCR 004 ISO	✓	✓	16	16	20	100	25	0	0					
SDJCR 005 ISO	✓	✓	16	16	20	100	25	0	0	DC.T 11T3..	DC..011	M5X0.5XM3.5	M3,5X14	T15
SDJCR 006 ISO	✓	✓	20	20	25	125	35	0	0					
SDJCR 007 ISO	✓	✓	25	25	32	150	40	0	0					
SDJCR 008 ISO	✓	✓	32	32	40	170	40	0	0					

► SCLCR ISO

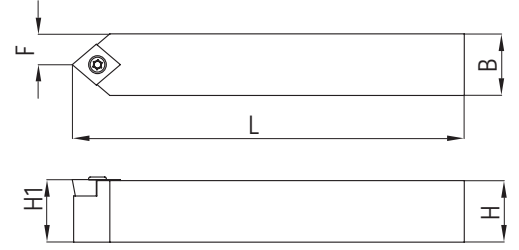

Kesici Uç Uyumluluğu Insert Suitability		Stok Stock												
ISO	R	L	H1 H	B	F	L1	L2	λS	Y0	Uç Insert	Altık Shim	Vida Screw	Vida Screw	Anahtar Torx Key
SCLCR 001 ISO	✓	✓	8	10	6	100	30	-10	0	CC.T 0602..	-	-	M2,5x5	T8
SCLCR 002 ISO	✓	✓	8	11	6	100	25	-10	0					
SCLCR 003 ISO	✓	✓	10	13	7	125	25	-10	0					
SCLCR 004 ISO	✓	✓	12	16	9	150	30	-8	0	CC.T 09T3..	-	-	M3,5x6	T15
SCLCR 005 ISO	✓	✓	12	16	9	150	30	-8	0					
SCLCR 006 ISO	✓	✓	16	20	11	180	35	-8	0	CC.T 0602..	-	-	M2,5x7	T8
SCLCR 007 ISO	✓	✓	16	20	11	180	35	-8	0	CC.T 09T3..	-	-	M3,5x8	T15
SCLCR 008 ISO	✓	✓	20	25	13	200	40	-8	0					
SCLCR 009 ISO	✓	✓	25	32	17	250	50	-8	0					
SCLCR 010 ISO	✓	✓	32	40	23	300	60	-8	0					
SCLCR 011 ISO	✓	✓	25	32	17	250	50	-8	0	CC.T 1204.	CC..12	M6xM4	M4x14	T15
SCLCR 012 ISO	✓	✓	32	40	23	300	60	-8	0					
SCLCR 013 ISO	✓	✓	40	50	27	400	70	-8	0					
SCLCR 015 ISO	✓	✓	25	32	17	250	50	-8	0	CC.T 09T3..	-	-	M3,5x8	

► SCNCN ISO

Kesici Uç Uyumluluğu Insert Suitability	Stok Stock		H1	H	B	F	L1	L2	λS	Y0				
	ISO	✓									✗	Uç Insert	Altık Shim	Vida Screw
SCNCN 001 ISO	✓		8	8	4	100	16	0	0	CC.T 0602..	-	-	M2,5X7	T08
SCNCN 002 ISO	✓		10	10	5	100	16	0	0	CC.T 09T3..	-	-	M3,5X11	T15
SCNCN 004 ISO	✓		16	16	8	100	25	0	0	CC.T 1204..	CC..012	M6XM4	M4X12	T20
SCNCN 005 ISO	✓		20	20	10	125	35	0	0	CC.T 0602..	-	-	M2,5X7	T08
SCNCN 006 ISO	✓		25	25	12,5	150	40	0	0	CC.T 0602..	-	-	M2,5X7	T15
SCNCN 008 ISO	✓		12	12	6	100	20	0	0	CC.T 09T3..	-	-	M3,5X11	T15
SCNCN 009 ISO	✓		12	12	6	150	40	0	0					

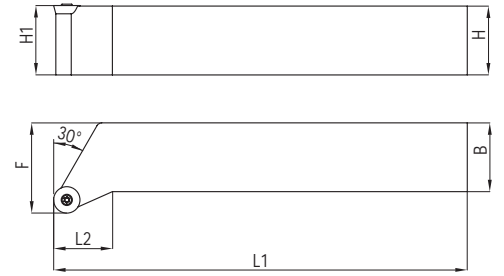
► SRGCR ISO

Kesici Uç Uyumluluğu Insert Suitability	Stok Stock		H1	H	B	F	L1	L2	λS	Y0			
	ISO	R									L	Uç Insert	Vida Screw
SRGCR 001 ISO	✓	✓	16	16	21	125	25	0	0	RC.T 0803..	M3X9	T10	
SRGCR 002 ISO	✓	✓	20	20	25	125	35	0	0				
SRGCR 003 ISO	✓	✓	25	25	32	150	40	0	0				
SRGCR 004 ISO	✓	✓	16	16	21	100	25	0	0	RC.T 10T3..	M4X11	T15	
SRGCR 005 ISO	✓	✓	20	20	25	125	35	0	0				
SRGCR 006 ISO	✓	✓	25	25	32	150	40	0	0				
SRGCR 007 ISO	✓	✓	32	32	40	170	40	0	0	RC.T 1204..	M4X11	T15	
SRGCR 008 ISO	✓	✓	16	16	21	100	25	0	0				
SRGCR 009 ISO	✓	✓	20	20	25	125	35	0	0				
SRGCR 010 ISO	✓	✓	25	25	32	150	40	0	0				
SRGCR 011 ISO	✓	✓	32	32	40	170	40	0	0				

► SRDCN ISO

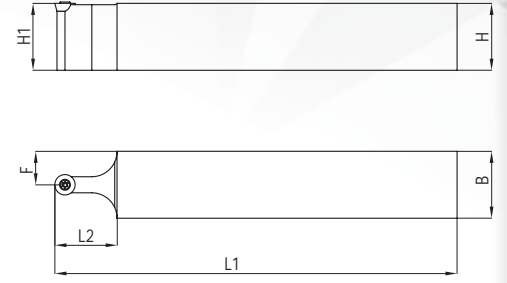





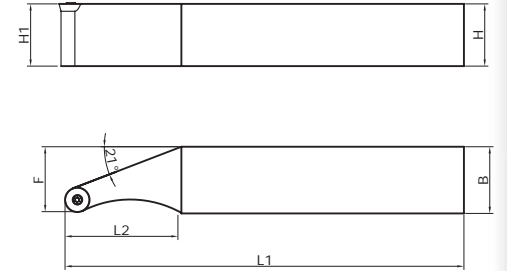

Kesici Uç Uyumluluğu Insert Suitability	Stok Stock		H1 H	B	F	L1	L2	λS	Y0	Uç Insert	Vida Screw	Anahtar Torx Key
	ISO											
SRDCN 001 ISO	✓		16	16	8	125	25	0	0	RC.T 0803..	M3X9	T10
SRDCN 002 ISO	✓		20	20	10	125	30	0	0			
SRDCN 003 ISO	✓		25	25	12,5	150	35	0	0			
SRDCN 004 ISO	✓		20	20	10	125	30	0	0	RC.T 10T3..	M4X11	T15
SRDCN 005 ISO	✓		25	25	12,5	150	35	0	0			
SRDCN 006 ISO	✓		20	20	10	125	30	0	0			
SRDCN 007 ISO	✓		25	25	12,5	150	35	0	0	RC.T 1204..	M5X12	T20
SRDCN 008 ISO	✓		25	25	12,5	150	35	0	0			
SRDCN 009 ISO	✓		16	16	8	100	20	0	0	RC.T 10T3..	M4X11	T15
SRDCN 010 ISO	✓		32	32	16	170	40	0	0			
SRDCN 011 ISO	✓		32	32	16	170	40	0	0	RC.T 1204..		

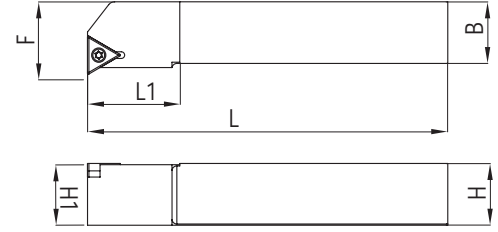
► SRHCR ISO



Kesici Uç Uyumluluğu Insert Suitability	Stok Stock		H1 H	B	F	L1	L2	λS	Y0	Uç Insert	Vida Screw	Anahtar Torx Key
	ISO	R										
SRHCR 001 ISO	✓	X	16	16	16	125	25	0	0	RC.T 0803..	M3X9	T10
SRHCR 002 ISO	✓	X	20	20	20	125	35	0	0			
SRHCR 003 ISO	✓	X	25	25	25	150	40	0	0			
SRHCR 004 ISO	✓	X	20	20	20	125	35	0	0	RC.T 10T3..	M4X11	T15
SRHCR 005 ISO	✓	X	25	25	25	150	40	0	0			
SRHCR 006 ISO	✓	X	20	20	20	125	35	0	0			
SRHCR 007 ISO	✓	X	25	25	25	150	40	0	0	RC.T 1204..	M4X11	T15
SRHCR 008 ISO	✓	X	32	32	32	125	35	0	0			
SRHCR 009 ISO	✓	X	16	16	16	125	35	0	0			

► STFCR ISO

Kesici Uç Uyumluluğu Insert Suitability		Stok Stock													
ISO	R	L	H1 H	B	F	L1	L2	λS	Y0	Uç Insert	Altık Shim	Vida Screw	Vida Screw	Anahtar Torx Key	
STFCR 001 ISO	✓	✓	16	16	20	100	25	0	0	TC.T 16T3..	-	-	M3.5X11	T10	
STFCR 002 ISO	✓	✓	20	20	25	125	35	0	0		TC..016	M5XM3.5	M3.5X14		
STFCR 003 ISO	✓	✓	25	25	32	150	40	0	0		TC.T 11..	-	-		M2,5
STFCR 004 ISO	✓	✓	12	12	16	100	25	0	0	-		-	M2,5	T8	
STFCR 005 ISO	✓	✓	16	16	20	100	25	0	0						

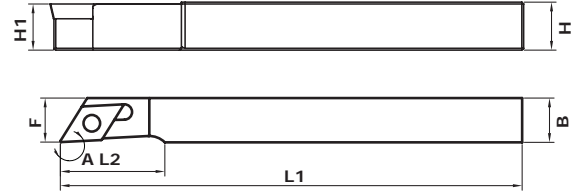
► DCMT 11 OTOMAT ISO

Kesici Uç Uyumluluğu Insert Suitability		Stok Stock											
ISO	R	L	H1 H	B	F	L1	L2	A	λS	Y0	Uç Insert	Vida Screw	Anahtar Torx Key
OT SDACL 001 ISO	✓	✓	12	12	12	125	24	90°	0	0	DC.T 11T3..	M3,5X9	T15
OT SDACR 001 ISO	✓	✓	12	12	12	125	24	90°	0	0			
OT SDJCL 001 ISO	✓	✓	12	12	12	125	24	93°	0	0			
OT SDJCR 001 ISO	✓	✓	12	12	12	125	24	93°	0	0			
OT SDNCN 001 ISO	✓	✓	12	12	12	125	24	93°	0	0			

► SER ISO

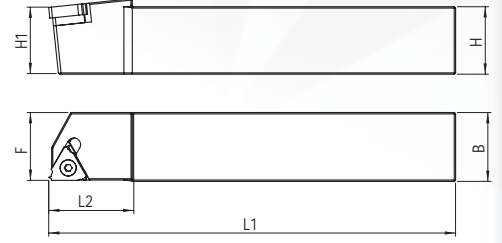

Kesici Uç Uyumluluğu Insert Suitability		Stok Stock															
ISO SER16	R	L	H1 H	B	F	L1	L2	λS	Y0	Uç Insert	Altlık Shim	Vida Screw	Vida Screw	Anahtar Torx Key	Pabuç Clamp	Vida Screw	
SER 001 ISO	✓	✓	8	8		100	20	-5,5	0	11 ER/L	-	-	M2,5X7	T08	-	-	
SER 003 ISO	✓	✓	12	12		100	20	-5,5	0	11 ER/L	-	-	M2,5X7	T08	-	-	
SER 004 ISO	✓	✓	12	12		100	20	-5,5	0	16 ER/L	ER/L..016	M5X- 0.5XM3.5	M3,5X14	T15	CK15	M4x12	
SER 005 ISO	✓	✓	16	16		125	30	-5,5	0	11 ER/L	-	-	M2,5X7	T08	-	-	
SER 006 ISO	✓	✓	16	16		125	30	-5,5	0	16 ER/L	ER/L..016	M5X- 0.5XM3.5	M3,5X14	T15	CK15	M4x12	
SER 007 ISO	✓	✓	20	20		125	35	-5,5	0								
SER 008 ISO	✓	✓	25	25		150	40	-5,5	0	22 ER/L	ER/L..022	-	M4X17	T20	-	-	
SER 009 ISO	✓	✓	25	25		150	40	-5,5	0								
SER 010 ISO	✓	✓	32	32		170	40	-5,5	0	16 ER/L	ER/L..016	M5X- 0.5XM3.5	M3,5X14	T15	CK15	M4x12	
SER 011 ISO	✓	✓	32	32		170	40	-5,5	0	22 ER/L	ER/L..022	-	M4X15	T20	-	-	

► SIR ISO

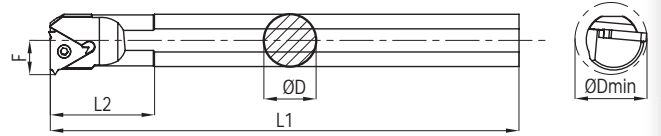

Kesici Uç Uyumluluğu Insert Suitability		Stok Stock																			
ISO SIR16	R	L	D	D min	F	L1	L2	λF	YP	Uç Insert	Altlık Shim	Vida Screw	Vida Screw	Anahtar Torx Key	Pabuç Clamp	Vida Screw					
SIR 001 ISO	✓	✓	10	13	7,5	125	25	-15	-1,5	11 IR/ER	-	-	M2,5X6	T08	-	-					
SIR 002 ISO	✓	✓	12	15	8,5	150	25	-15	-1,5		-	-			-	-	-	-			
SIR 003 ISO	✓	✓	16	13	7,5	180	40	-15	-1,5		-	-			-	-	-	-			
SIR 004 ISO	✓	✓	16	20	11	180	30	-15	-1,5		-	-			-	-	-	-			
SIR 005 ISO	✓	✓	16	20	11	180	30	-15	-1,5	16 IR/ER	-	-	M3,5X8	T15	-	-					
SIR 006 ISO	✓	✓	20	25	13	200	35	-15	-1,5		-	-			-	-	-	-			
SIR 007 ISO	✓	✓	25	32	17	250	35	-15	-1,5		-	-			-	-	-	-			
SIR 008 ISO	✓	✓	32	40	21	300	40	-15	-1,5	22 IR/ER	IR/ER 016	M5X- 0.5XM3.5	M3,5X14	T15	CK15	M4X12					
SIR 009 ISO	✓	✓	40	50	26	400	50	-15	-1,5												
SIR 010 ISO	✓	✓	25	32	17	250	35	-15	-1,5	22 IR/ER	IR/ER 022	-	M4X17	T20	CK15	M4X12					
SIR 011 ISO	✓	✓	32	40	21	300	40	-15	-1,5			-					-	-	-	-	-
SIR 012 ISO	✓	✓	40	50	26	400	50	-15	-1,5			-					-	-	-	-	-
SIR 013 ISO	✓	✗	50	63	35	450	70	-15	-1,5			-					-	-	-	-	-



► CTGPR ISO

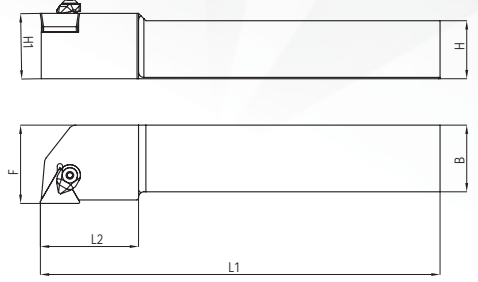

Kesici Uç Uyumluluğu Insert Suitability		Stok Stock													
ISO	R	L	H1-H	B	F	L1	L2	λ S	γ 0	Uç Insert	Altık Shim	Vida Screw	Pabuç Clamp	Vida Screw	Anahtar Allen Key
CTGPR 001 ISO	✓	X	16	16	16	100	30	-6	-6	TP.. 1103			TP11	M5X12	A3
CTGPR 002 ISO	✓	✓	16	16	20	100	30	-6	-6		-	-	-		
CTGPR 003 ISO	✓	✓	20	20	25	125	35	-6	-6	TP.. 1603..	TP16	M5X12	TP16	-	A3
CTGPR 004 ISO	✓	✓	25	25	32	150	40	-6	-6					-	
CTGPR 005 ISO	✓	✓	25	25	32	150	40	-6	-6	TP.. 2204..	-	-	TP22	M6X22	A4

► CKJNR ISO

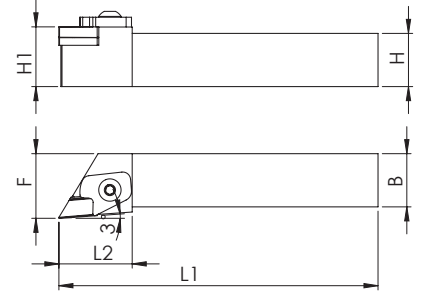

Kesici Uç Uyumluluğu Insert Suitability		Stok Stock													
ISO	R	L	H1-H	B	F	L1	L2	λ S	γ 0	Uç Insert	Altık Shim	Vida Screw	Pabuç Clamp	Vida Screw	Anahtar Allen Key
CKJNR 001 ISO	✓	✓	20	20	25	125	35	-6	-6	KNUX 11	-	-	C110105	M4X12	A5
CKJNR 002 ISO	✓	✓	25	25	32	150	40	-6	-6						
CKJNR 004 ISO	✓	✓	20	20	25	125	35	-6	-6	KNUX 1604..	KN..016	M3X10	C160105	M6X22	A5
CKJNR 006 ISO	✓	✓	25	25	32	150	40	-6	-6						
CKJNR 007 ISO	✓	✓	32	32	40	170	40	-6	-6						
CKJNR 008 ISO	✓	✓	40	40	50	200	45	-6	-6						

► TDJNR ISO

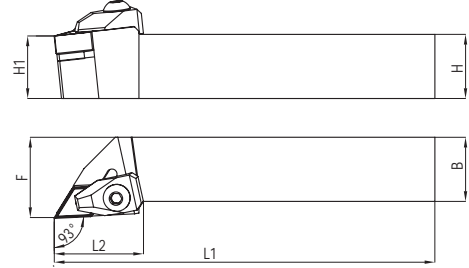

Kesici Uç Uyumluluğu Insert Suitability		Stok Stock													
ISO	R	L	H1 H	B	F	L1	L2	λS	Y0	Uç Insert	Altılık Shim	Vida Screw	Pabuç Clamp	Vida Screw	Anahtar Allen Key
TDJNR 001 ISO	✓	✓	16	16	21	125	30	-6	-6	DNM. 1104..	DN..011	M4X11 T15	T110105	M5X23	A3
TDJNR 002 ISO	✓	✓	20	20	25	125	35	-6	-6						
TDJNR 003 ISO	✓	✓	25	25	32	150	40	-6	-6						
TDJNR 004 ISO	✓	✓	20	20	25	125	35	-6	-6	DNM. 1506..	DN..015	M4X8 A2,5	T150105	M6X27	
TDJNR 005 ISO	✓	✓	25	25	32	150	40	-6	-6						
TDJNR 006 ISO	✓	✓	32	32	40	170	40	-6	-6						
TDJNR 007 ISO	✓	✓	40	40	50	200	45	-6	-6						
TDJNR 008 ISO	✓	✓	16	16	21	125	30	-6	-6						

► TDNNN ISO

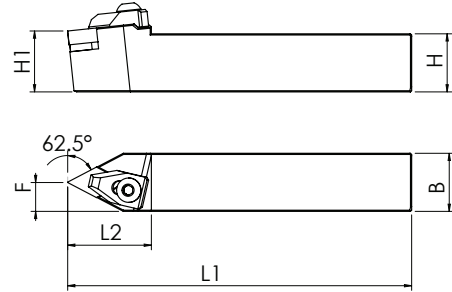

Kesici Uç Uyumluluğu Insert Suitability		Stok Stock													
ISO	R	L	H1 H	B	F	L1	L2	λS	Y0	Uç Insert	Altılık Shim	Vida Screw	Pabuç Clamp	Vida Screw	Anahtar Allen Key
TDNNN 001 ISO	✓	✓	16	16	8	125	30	-10	0	DNM. 1104..	DN..011	M4X8 T15	T110105	M5X23	A3
TDNNN 002 ISO	✓	✓	20	20	10	125	35	-10	0						
TDNNN 003 ISO	✓	✓	25	25	12,5	150	40	-10	0						
TDNNN 004 ISO	✓	✓	20	20	10	125	35	-10	0	DNM. 1506..	DN..015	M4X8 A2,5	T150105	M6X27	
TDNNN 005 ISO	✓	✓	25	25	12,5	150	40	-10	0						
TDNNN 006 ISO	✓	✓	32	32	16	170	40	-10	0						
TDNNN 007 ISO	✓	✓	40	40	20	200	45	-10	0						

► TTGNR ISO

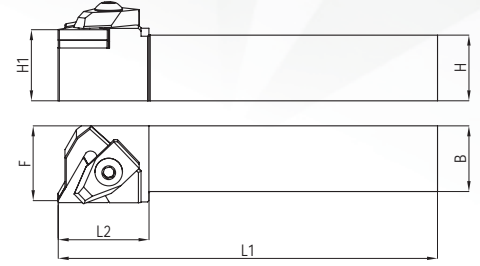





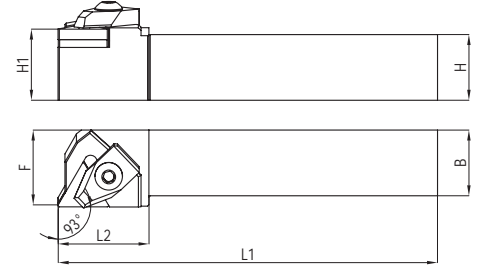

Kesici Uç Uyumluluğu Insert Suitability		Stok Stock													
ISO	R	L	H1-H	B	F	L1	L2	λS	Y0	Uç Insert	Altık Shim	Vida Screw	Pabuç Clamp	Vida Screw	Anahtar Allen Key
TTGNR 001 ISO	✓	✓	20	20	25	125	35	-6	-6	TNMG 1604	TN..016(H)	M4X8 A2,5	T160105	M5X23	A3
TTGNR 002 ISO	✓	✓	25	25	32	150	40	-6	-6						
TTGNR 003 ISO	✓	✓	20	20	25	125	40	-6	-6	TNMG 2204	TN..022(H)	M4X8 A2,5	T220105	M6X27	
TTGNR 004 ISO	✓	✓	25	25	32	150	40	-6	-6						
TTGNR 005 ISO	✓	✓	32	32	40	170	40	-6	-6						
TTGNR 006 ISO	✓	✓	40	40	50	200	45	-6	-6						

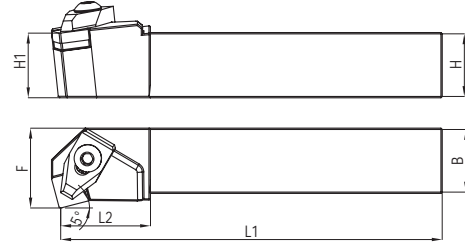
► TTJNR ISO







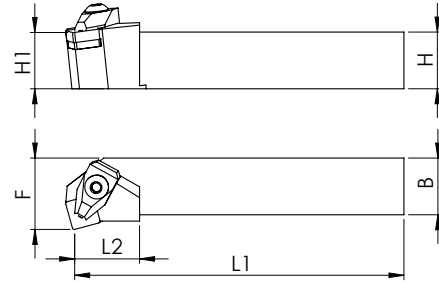

Kesici Uç Uyumluluğu Insert Suitability		Stok Stock													
ISO	R	L	H1-H	B	F	L1	L2	λS	Y0	Uç Insert	Altık Shim	Vida Screw	Pabuç Clamp	Vida Screw	Anahtar Allen Key
TTJNR 001 ISO	✓	✓	16	16	21	125	35	-6	-6	TNMG 1604	TN..016(H)	M4X8 A2,5	T110105	M5X23	A3
TTJNR 002 ISO	✓	✓	20	20	25	125	35	-6	-6						
TTJNR 003 ISO	✓	✓	25	25	32	150	40	-6	-6	TNMG 2204	TN..022(H)	M4X8 A2,5	T150105	M6X27	
TTJNR 004 ISO	✓	✓	20	20	25	125	35	-6	-6						
TTJNR 005 ISO	✓	✓	25	25	32	150	40	-6	-6						
TTJNR 006 ISO	✓	✓	32	32	40	170	40	-6	-6						
TTJNR 007 ISO	✓	✓	40	40	50	200	45	-6	-6						

TSLNR ISO

Kesici Uç Uyumluluğu Insert Suitability		Stok Stock													
ISO	R	L	H1 H	B	F	L1	L2	λS	Y0	Uç Insert	Altılık Shim	Vida Screw	Pabuç Clamp	Vida Screw	Anahtar Allen Key
TSLNR 001 ISO	✓	✓	20	20	25	125	35	-6	-6	SNMG 1204	SN..012	M4X8 A2,5	T120105	M6X27	A3
TSLNR 002 ISO	✓	✓	25	25	32	150	40	-6	-6						
TSLNR 003 ISO	x	x	32	32	40	170	40	-6	-6	SNMG 1506	SN..015	M5X10	T160105	M6X27	A3
TSLNR 005 ISO	✓	x	32	32	40	170	40	-6	-6						
TSLNR 006 ISO	✓	x	40	40	50	170	40	-6	-6	SNMG 1906	SN..019	M5X10	T190105	M8X25	A5
TSLNR 007 ISO	✓	x	32	32	40	170	40	-6	-6						
TSLNR 004 ISO	✓	x	40	40	50	200	45	-6	-6						

TSKNR ISO

Kesici Uç Uyumluluğu Insert Suitability		Stok Stock													
ISO	R	L	H1 H	B	F	L1	L2	λS	Y0	Uç Insert	Altılık Shim	Vida Screw	Pabuç Clamp	Vida Screw	Anahtar Allen Key
TSKNR 001 ISO	x	x	20	20	25	125	35	-6	-6	SNMG 1204	SN..012	M4X8 A2,5	T120105	M6X27	A3
TSKNR 002 ISO	✓	✓	25	25	32	150	40	-6	-6					M6X27	A3
TSKNR 005 ISO	x	x	32	32	40	170	40	-6	-6	SNMG 1506	SN..015	M5X10	T160105	M6X27	A3
TSKNR 007 ISO	x	x	40	40	50	200	45	-6	-6	SNMG 1906	SN..019	M5X10	T190105	M8X25	A5

► **TSRNR ISO**

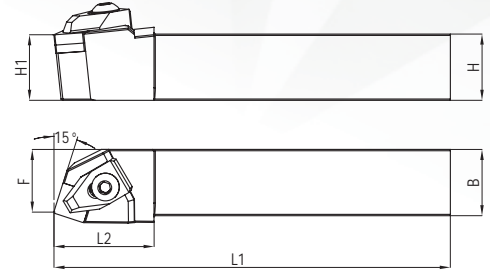

Kesici Uç Uyumluluğu Insert Suitability		Stok Stock													
ISO	R	L	H1-H	B	F	L1	L2	λS	Y0	Uç Insert	Altık Shim	Vida Screw	Pabuç Clamp	Vida Screw	Anahtar Allen Key
TSRNR 001 ISO	✓	✓	20	20	19	125	35	-6	-6	SNMG 1204	SN..012	M4X8 A2,5	T120105	M6X27	A3
TSRNR 002 ISO	✓	✓	25	25	24	150	40	-6	-6					M6X27	A3
TSRNR 003 ISO	X	X	32	32	30	170	40	-6	-6	SNMG 1506	SN..015	M5X10	T160105	M6X27	A3
TSRNR 004 ISO	X	X	40	40	38	200	45	-6	-6	SNMG 1906			SN..019	T190105	M8X25
TSRNR 005 ISO	X	X	32	32	30	170	40	-6	-6	SNMG 1204	SN..012	M4X8 A2,5	T120105	M6X27	A3
TSRNR 006 ISO	X	X	32	32	30	170	40	-6	-6	SNMG 1906	SN..019	M5X10	T190105	M8X25	A3
TSRNR 007 ISO	X	X	40	40	38	200	45	-6	-6	SNMG 1506			SN..015	T160105	M6X27



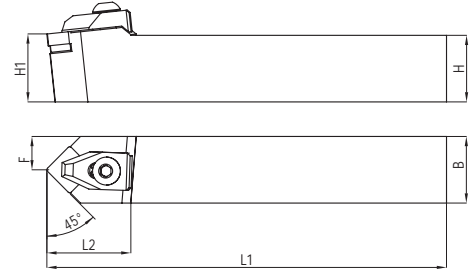



► **TSDNN ISO**

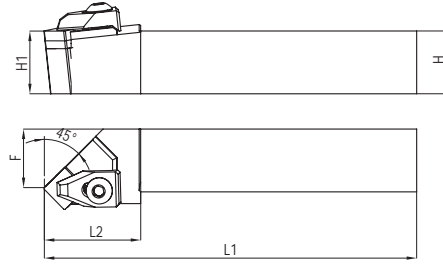

Kesici Uç Uyumluluğu Insert Suitability		Stok Stock													
ISO	R	L	H1-H	B	F	L1	L2	λS	Y0	Uç Insert	Altık Shim	Vida Screw	Pabuç Clamp	Vida Screw	Anahtar Allen Key
TSDNN 001 ISO	✓	✓	20	20	10	125	35	-10	0	SNMG 1204	SN..012	M4X8 A2,5	T120105	M6X27	A3
TSDNN 002 ISO	✓	✓	25	25	12,5	150	40	-10	0						
TSDNN 003 ISO	✓	✓	32	32	16	170	40	-10	0	SNMG 1506	SN..015	M4X8 A2,5	T150105	M6X27	A3
TSDNN 004 ISO	✓	✓	40	40	20	200	45	-10	0	SNMG 1906	SN..019	M5X10	T190105	M8X25	A5
TSDNN 005 ISO	✓	✓	32	32	16	170	40	-10	0	SNMG 1204	SN..012	M4X8 A2,5	T120105	M6X27	A3
TSDNN 006 ISO	✓	✓	32	32	16	170	40	-10	0	SNMG 1906	SN..019	M5X10	T190105	M8X25	A5
TSDNN 007 ISO	✓	✓	40	40	20	200	45	-10	0	SNMG 1506	SN..015	M4X8 A2,5	T150105	M6X27	A3

► TSSNR ISO



Kesici Uç Uyumluluğu Insert Suitability		Stok Stock													
ISO	R	L	H1-H	B	F	L1	L2	λS	Y0	Uç Insert	Altık Shim	Vida Screw	Pabuç Clamp	Vida Screw	Anahtar Allen Key
TSSNR 001 ISO	✓	✓	20	20	19	125	35	-6	-6	SNMG 1204	SN..012	M4X8 A2,5	T120105	M6X27	A3
TSSNR 002 ISO	✓	✓	25	25	24	150	40	-6	-6						
TSSNR 003 ISO	✓	✓	32	32	30	170	40	-6	-6	SNMG 1506	SN..015	M5X10	T160105		
TSSNR 004 ISO	✓	✓	40	40	38	200	45	-6	-6	SNMG 1906	SN..019	M5X10	T190105	M8X25	A5
TSSNR 005 ISO	✓	✓	32	32	30	170	40	-6	-6	SNMG 1204	SN..012	M4X8 A2,5	T120105	M6X27	A3
TSSNR 006 ISO	✓	✓	32	32	30	170	40	-6	-6	SNMG 1906	SN..019	M5X10	T190105	M8X25	A5
TSSNR 007 ISO	✓	✓	32	32	30	170	40	-6	-6	SNMG 1506	SN..015	M5X10	T160105	M6X27	A3

► TWLNR ISO

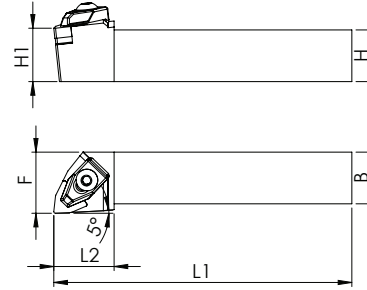

Kesici Uç Uyumluluğu Insert Suitability		Stok Stock													
ISO	R	L	H1-H	B	F	L1	L2	λS	Y0	Uç Insert	Altık Shim	Vida Screw	Pabuç Clamp	Vida Screw	Anahtar Allen Key
TWLNR 001 ISO	✓	✓	16	16	21	125	30	-6	-6	WNM.0602..	-	-	T060105	M5X15	A3
TWLNR 002 ISO	✓	✓	20	20	25	125	35	-6	-6						
TWLNR 003 ISO	✓	✓	25	25	32	150	40	-6	-6	WNM.0804..	WN..008(H)	M4X8 A2.5	T080105	M6X27	A3
TWLNR 004 ISO	✓	✓	20	20	25	125	35	-6	-6						
TWLNR 005 ISO	✓	✓	25	25	32	150	40	-6	-6						
TWLNR 006 ISO	✓	✓	32	32	40	170	40	-6	-6						
TWLNR 007 ISO	✓	✓	40	40	50	200	45	-6	-6						
TWLNR 008 ISO	✓	✓	32	32	40	170	40	-6	-6	WNM.10	-	-	T100105		
TWLNR 009 ISO	✓	✓	40	40	50	200	45	-6	-6	WNM.10	-	-	T100105		

► TVJNR ISO

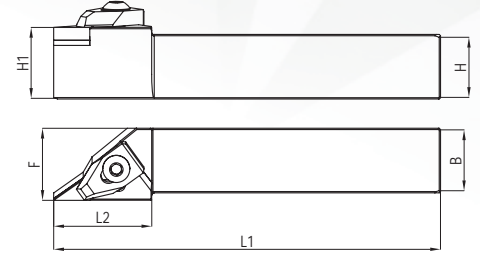

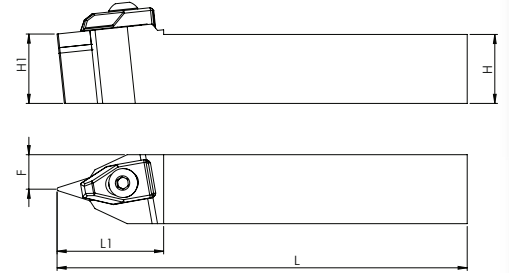

Kesici Uç Uyumluluğu Insert Suitability		Stok Stock		H1-H	B	F	L1	L2	λS	Y0	Uç Insert	Altık Shim	Vida Screw	Pabuç Clamp	Vida Screw	Anahtar Allen Key
ISO	R	L														
TVJNR 000 ISO	✓	✓	16	16	25	125	35	-6	-6		VNMG 1604	VN..016	M4X11 T15	T160105	M6X27	A3
TVJNR 001 ISO	✓	✓	20	20	25	125	35	-6	-6							
TVJNR 002 ISO	✓	✓	25	25	32	150	40	-6	-6							
TVJNR 003 ISO	✓	✓	32	32	40	170	40	-6	-6							
TVJNR 004 ISO	✓	✓	40	40	50	200	45	-6	-6							

► TVNNN ISO

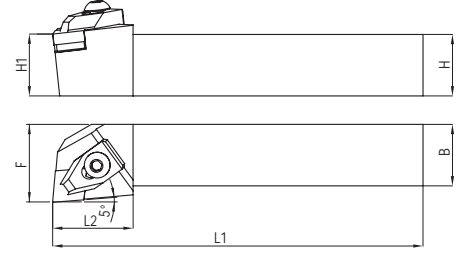

Kesici Uç Uyumluluğu Insert Suitability		Stok Stock		H1-H	B	F	L1	L2	λS	Y0	Uç Insert	Altık Shim	Vida Screw	Pabuç Clamp	Vida Screw	Anahtar Allen Key
ISO	R	L														
TVNNN 001 ISO	✓		20	20	10	125	30	-10	0		VNMG 1604	VN..016	M4X11 T15	T160105	M6X27	A3
TVNNN 002 ISO	✓		25	25	12,5	150	35	-10	0							
TVNNN 003 ISO	✓		32	32	16	170	40	-10	0							
TVNNN 004 ISO	✓		40	40	16	170	40	-10	0							

TCLNR ISO



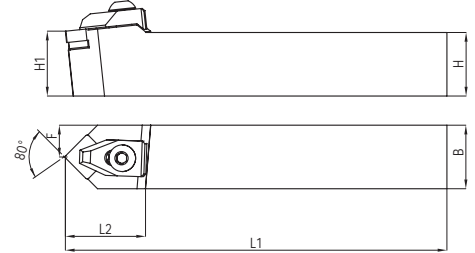

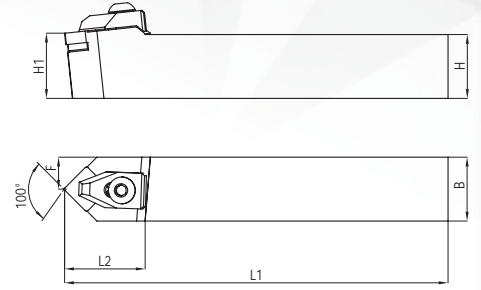

Kesici Uç Uyumluluğu Insert Suitability		Stok Stock													
ISO	R	L	H1 H	B	F	L1	L2	λS	Y0	Uç Insert	Altık Shim	Vida Screw	Pabuç Clamp	Vida Screw	Anahtar Allen Key
TCLNR 001 ISO	✓	✓	20	20	25	125	35	-6	-6	CNM. 1204..	CN..012	M4X8 A2,5	T120105	M6X27	A3
TCLNR 002 ISO	✓	✓	25	25	32	150	40	-6	-6						
TCLNR 003 ISO	✓	✓	32	32	40	170	40	-6	-6						
TCLNR 004 ISO	✓	✓	25	25	32	150	40	-6	-6	CNM. 1606..	CN..016	M5X10	T160105	M6X27	A3
TCLNR 005 ISO	✓	✓	32	32	40	170	40	-6	-6						
TCLNR 006 ISO	✓	✓	32	32	40	170	40	-6	-6	CNM. 1906..	CN..019	M5X10	T190105	M8X25	A5
TCLNR 007 ISO	✓	✓	40	40	50	200	45	-6	-6						
TCLNR 008 ISO	✓	✗	40	40	50	200	45	-6	-6	CNM. 1606..	CN..016	M5X10	T160105	M6X27	A3
TCLNR 009 ISO	✓	✓	16	16	25	100	35	-6	-6	CNM. 1204..	CN..012	M4X8 A2,5	T120105	M6X27	A3

TCZNN ISO

Kesici Uç Uyumluluğu Insert Suitability		Stok Stock													
ISO	R	L	H1 H	B	F	L1	L2	λS	Y0	Uç Insert	Altık Shim	Vida Screw	Pabuç Clamp	Vida Screw	Anahtar Allen Key
TCZNN 001 ISO	✓	✓	20	20	10	125	35	-10	0	CNM. 1204..	CN..012	M4X8 A2,5	T120105	M6X27	A3
TCZNN 002 ISO	✓	✓	25	25	12,5	150	40	-10	0						
TCZNN 003 ISO	✓	✓	32	32	16	170	40	-10	0						
TCZNN 004 ISO	✓	✓	32	32	16	200	40	-10	0	CNM. 1906..	CN..019	M5X8 A2,5	T190105	M8X27	A5
TCZNN 005 ISO	✓	✓	40	40	16	250	40	-10	0						

► TCMNN ISO



Kesici Uç Uyumluluğu Insert Suitability	Stok Stock													
		H1 H	B	F	L1	L2	λS	Y0	Uç Insert	Altılık Shim	Vida Screw	Pabuç Clamp	Vida Screw	Anahtar Allen Key
TCMNN 001 ISO	✓	20	20	10	125	35	-10	0	CNM. 1204..	CN..012	M4X8 A2,5	T120105	M6X27	A3
TCMNN 002 ISO	✓	25	25	12,5	150	40	-10	0						
TCMNN 003 ISO	✓	32	32	16	170	40	-10	0						

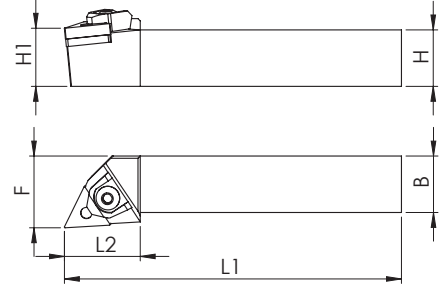

► MTJNR ISO

Kesici Uç Uyumluluğu Insert Suitability		Stok Stock		H1 H	B	F	L1	L2	λS	Y0	Uç Insert	Altlık Shim	Altlık Pimi Lock Pin	Pabuç Clamp	Vida Screw	Anahtar Allen Key
ISO	R	L														
MTJNR 001 ISO	✓	✓	16	16	20	125	35	-6	-6		TNM.1604	TN..016 (P)	5X3.6X15	M160105	M6X27	A3
MTJNR 002 ISO	✓	✓	20	20	25	125	35	-6	-6							
MTJNR 003 ISO	✓	✓	25	25	32	150	40	-6	-6							
MTJNR 004 ISO	✓	✓	32	32	40	170	40	-6	-6							
MTJNR 005 ISO	✓	✓	25	25	32	150	40	-6	-6		TNM.2204	TN..022 (P)	6X5X18	M220105	M6X27	A3
MTJNR 006 ISO	✓	✓	32	32	40	170	40	-6	-6							
MTJNR 007 ISO	✓	✓	40	40	50	200	45	-6	-6							

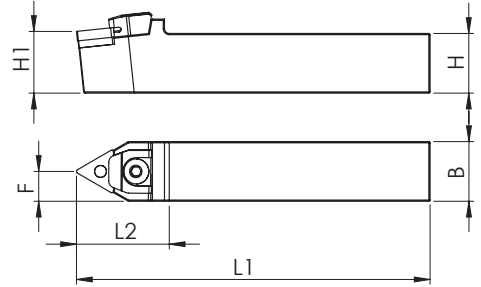
► MTENN ISO

Kesici Uç Uyumluluğu Insert Suitability		Stok Stock		H1 H	B	F	L1	L2	λS	Y0	Uç Insert	Altlık Shim	Altlık Pimi Lock Pin	Pabuç Clamp	Vida Screw	Anahtar Allen Key
ISO	R	L														
MTENN 001 ISO	✓		16	16	8	125	35	-10	0		TNM.1604	TN..016 (P)	5X3.6X15	M160105	M5X23	A3
MTENN 002 ISO	✓		20	20	10	125	35	-10	0							
MTENN 003 ISO	✓		25	25	12,5	150	40	-10	0							
MTENN 004 ISO	✓		32	32	16	170	40	-10	0							
MTENN 005 ISO	✓		25	25	12,5	150	40	-10	0		TNM.2204	TN..022 (P)	6X5X18	M220105	M6X27	A3
MTENN 006 ISO	✓		32	32	16	170	40	-10	0							
MTENN 007 ISO	✓		40	40	20	200	45	-10	0							

► MWLNR ISO

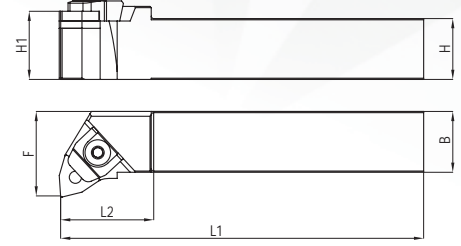

Kesici Uç Uyumluluğu Insert Suitability		Stok Stock													
ISO	R	L	H1 H	B	F	L1	L2	λS	Y0	Uç Insert	Altık Shim	Altık Pimi Lock Pin	Pabuç Clamp	Vida Screw	Anahtar Allen Key
MWLNR 001 ISO	✓	✓	16	16	20	125	35	-6	-6	WNM.0604	-	5X3.6X15	M060105	M5X23	A3
MWLNR 002 ISO	✓	✓	20	20	25	125	35	-6	-6						
MWLNR 003 ISO	✓	✓	25	25	32	150	40	-6	-6						
MWLNR 004 ISO	✓	✓	20	20	25	125	35	-6	-6	WNM.0804	WN.008(P)	6X5X18	M080105	M6X27	
MWLNR 005 ISO	✓	✓	25	25	32	150	40	-6	-6						
MWLNR 006 ISO	✓	✓	32	32	40	170	40	-6	-6						
MWLNR 007 ISO	✓	✓	40	40	50	200	45	-6	-6						

► MWDNN ISO

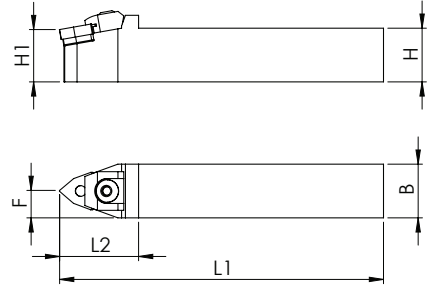

Kesici Uç Uyumluluğu Insert Suitability		Stok Stock													
ISO	R	L	H1 H	B	F	L1	L2	λS	Y0	Uç Insert	Altık Shim	Altık Pimi Lock Pin	Pabuç Clamp	Vida Screw	Anahtar Allen Key
MWDNN 001 ISO	X	X	16	16	8	125	35	-10	0	WNM.0604	-	5X3.6X15	M060105	M5X23	A3
MWDNN 002 ISO	X	X	20	20	10	125	35	-10	0						
MWDNN 003 ISO	✓	✓	20	20	10	125	40	-10	0	WNM.0804	WN..08(P)	6X5X18	M080105	M6X27	
MWDNN 004 ISO	✓	✓	25	25	12,5	150	40	-10	0						
MWDNN 005 ISO	X	X	32	32	16	170	40	-10	0						
MWDNN 006 ISO	X	X	40	40	20	200	45	-10	0						



► SVUBR ISO

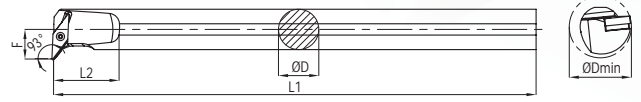

Kesici Uç Uyumluluğu Insert Suitability	Stok Stock								
	R	L	D	D min	F	L1	L2	λF	YP
ISO									
SVUBR 001 ISO	✓	✓	16	20	11	180	40	-8	0
SVUBR 002 ISO	✓	✓	20	25	13	200	40	-8	0
SVUBR 003 ISO	✓	✓	25	32	17	250	50	-9	0
SVUBR 004 ISO	✓	✓	32	40	22	300	60	-9	0
SVUBR 005 ISO	✓	✓	40	50	27	400	70	-9	0

Uç Insert	Aitlik Shim	Vida Screw	Vida Screw	Anahtar Torx Key
VBM. 1103..	-	-	M2.5X7	T08
VBM. 1604..	VB..016	M5X0.5XM3.5	M3.5X11	T15

► SVUCR ISO

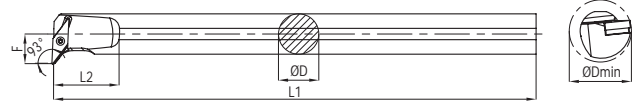



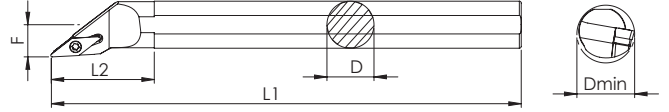

Kesici Uç Uyumluluğu Insert Suitability	Stok Stock								
	R	L	D	D min	F	L1	L2	λF	YP
ISO									
SVUCR 001 ISO	✓	✓	16	20	11	180	40	-8	0
SVUCR 002 ISO	✓	✓	20	25	13	200	40	-8	0
SVUCR 003 ISO	✓	✓	25	32	17	250	50	-9	0
SVUCR 004 ISO	✓	✓	32	40	22	300	60	-9	0
SVUCR 005 ISO	✓	✓	40	50	27	400	70	-9	0

Uç Insert	Aitlik Shim	Vida Screw	Vida Screw	Anahtar Torx Key
VCM. 1103..	-	-	M2.5X7	T08
VCM. 1604..	VC..016	M5X0.5XM3.5	M3.5X11	T15





► SVJBR ISO

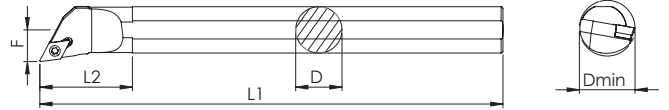

Kesici Uç Uyumluluğu Insert Suitability		Stok Stock												
ISO	R	L	D	D min	F	L1	L2	λF	YP	Uç Insert	Altılık Shim	Vida Screw	Vida Screw	Anahtar Torx Key
SVJBR 001 ISO	✓	✓	25	32	17	250	50	-	-	VCM. 1604..	VC..016	M5X0.5XM3.5	M3.5X11	T15
SVJBR 002 ISO	✓	✓	32	40	23	300	80	-	-					
SVJBR 003 ISO	✓	✓	40	50	27	400	80	-	-					

► SDPCR ISO



Kesici Uç Uyumluluğu Insert Suitability		Stok Stock												
ISO	R	L	D	D min	F	L1	L2	λF	YP	Uç Insert	Altılık Shim	Vida Screw	Vida Screw	Anahtar Torx Key
SDPCR 001 ISO	✓	✓	10	13	7,5	125	25	-	-	DC.T 0702..	-	-	M2,5X5	T08
SDPCR 002 ISO	✓	✓	12	16	9	150	30	-	-				M3,5X8	
SDPCR 003 ISO	✓	✓	16	20	11	180	35	-	-	DC.T 11T3	DC..011	M5X0.5XM3.5	M3,5X11	T15
SDPCR 004 ISO	✓	✓	20	25	13	200	40	-	-					
SDPCR 005 ISO	✓	✓	25	32	17,5	250	50	-	-					
SDPCR 006 ISO	✓	✓	32	40	23	300	60	-	-					

► SDUCR ISO

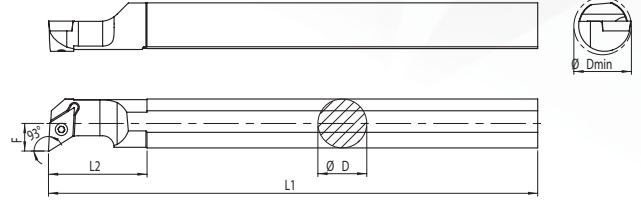





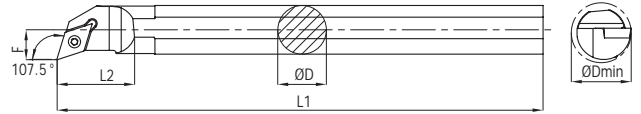

Kesici Uç Uyumluluğu Insert Suitability		Stok Stock													
ISO	R	L	D	D min	F	L1	L2	λF	YP	Uç Insert	Altık Shim	Vida Screw	Vida Screw	Anahtar Torx Key	
SDUCR 001 ISO	✓	✓	10	13	7,5	125	25	-11	0	DC.T 0702..			M2,5X5	T08	
SDUCR 002 ISO	✓	✓	12	16	9	150	30	-9	0				DC.T 11T3..		M2,5X7
SDUCR 003 ISO	✓	✓	16	20	11	180	35	-9	0	DC.T 0702..				M3,5X8	T15
SDUCR 004 ISO	✓	✓	16	20	11	180	35	-9	0				DC.T 11T3..	M2,5X7	T08
SDUCR 005 ISO	✓	✓	20	25	13	200	40	-8	0	DC.T 11T3..				M3,5X8	T15
SDUCR 006 ISO	✓	✓	20	25	13	200	40	-8	0				DC.T 0702..	M2,5X7	T08
SDUCR 007 ISO	✓	✓	25	32	17,5	250	50	-8	0	DC.T 11T3..				M5X0.5XM3.5	M3,5X11
SDUCR 008 ISO	✓	✓	25	32	17,5	250	50	-8	0				DC.T 11T3..	DC..011	M5X0.5XM3.5
SDUCR 009 ISO	✓	✓	32	40	23	300	60	-8	0						
SDUCR 010 ISO	✓	✓	40	50	27	400	60	-8	0						

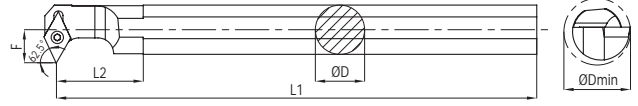
► SDQCR ISO





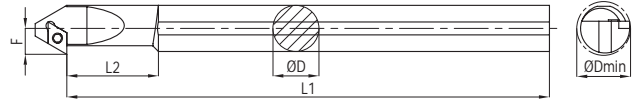

Kesici Uç Uyumluluğu Insert Suitability		Stok Stock														
ISO	R	L	D	D min	F	L1	L2	λF	YP	Uç Insert	Altık Shim	Vida Screw	Vida Screw	Anahtar Torx Key		
SDQCR 001 ISO	✓	✓	10	13	7,5	125	25	-11	0	DC.T 0702..			M2,5X5	T08		
SDQCR 002 ISO	✓	✓	12	16	9	150	30	-9	0				DC.T 11T3..		M2,5X7	
SDQCR 003 ISO	✓	✓	16	20	11	180	35	-9	0	DC.T 0702..				M3,5X8	T15	
SDQCR 004 ISO	✓	✓	20	25	13	200	40	-8	0				DC.T 11T3..	M2,5X7	T08	
SDQCR 005 ISO	✓	✓	16	20	11	180	35	-9	0	DC.T 11T3..				M5X0.5XM3.5	M3,5X11	T15
SDQCR 006 ISO	✓	✓	20	25	13	200	40	-8	0				DC..011	M5X0.5XM3.5	M3,5X11	T15
SDQCR 007 ISO	✓	✓	25	32	17,5	250	50	-8	0							
SDQCR 008 ISO	✓	✓	25	32	17,5	250	50	-8	0							
SDQCR 009 ISO	✓	✓	32	40	23	300	60	-8	0							

► SD-CR ISO

Kesici Uç Uyumluluğu Insert Suitability		Stok Stock												
ISO	R	L	D	D min	F	L1	L2	λF	YP	Uç Insert	Altılık Shim	Vida Screw	Vida Screw	Anahtar Torx Key
SD-CR 001 ISO	✓	✓	10	14	8,5	125	28	-9	0	DC.T 0702..	-	-	M2.5X7	T08
SD-CR 002 ISO	✓	✓	12	16	9	150	30	-9	0		-	-		
SD-CR 003 ISO	✓	✓	16	23	14	180	40	-8	0		-	-		
SD-CR 004 ISO	✓	✓	16	23	14	180	40	-8	0	DC.T 11T3..	-	-	M3.5X8	T15
SD-CR 005 ISO	✓	✓	20	25	14,5	200	45	-8	0		-	-		
SD-CR 006 ISO	✓	✓	25	32	19	250	55	-8	0		DC..011	M5X0.5XM3.5	M3.5X11	
SD-CR 007 ISO	✓	✓	32	40	23	300	60	-12	0					
SD-CR 008 ISO	✓	✗	32	50	27	400	70	-10	0					

► SDXCR ISO

Kesici Uç Uyumluluğu Insert Suitability		Stok Stock												
ISO	R	L	D	D min	F	L1	L2	λF	YP	Uç Insert	Altılık Shim	Vida Screw	Vida Screw	Anahtar Torx Key
SDXCR 001 ISO	✓	✓	12	16	9	150	30	-7	0	DC.T 0702..	-	-	M2.5X5	T08
SDXCR 002 ISO	✓	✓	16	22	12,5	180	40	-9	0		-	-		
SDXCR 003 ISO	✓	✓	16	22	12,5	180	40	-9	0		-	-		
SDXCR 004 ISO	✓	✓	20	25	14	200	55	-9	0	DC.T 11T3..	-	-	M3.5X8	T15
SDXCR 005 ISO	✓	✓	25	32	17,5	250	65	-10	0		DC..011	M5X0.5XM3.5		
SDXCR 006 ISO	✓	✓	32	40	23	300	80	-13	0					
SDXCR 007 ISO	✓	✓	40	50	27	400	80	-13	0					

► SCLCR ISO

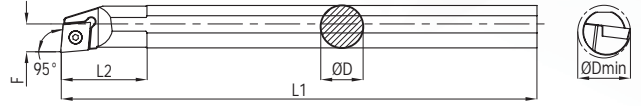

Kesici Uç Uyumluluğu Insert Suitability		Stok Stock												
ISO	R	L	D	D min	F	L1	L2	λF	YP	Uç Insert	Altık Shim	Vida Screw	Vida Screw	Anahtar Torx Key
SCLCR/S 001 ISO	✓	✓	8	10	6	100	30	-10	0	CC.T 0602..			M2,5X5	T08
SCLCR/S 002 ISO	✓	✓	8	11	6	100	25	-10	0					
SCLCR/S 003 ISO	✓	✓	10	13	7	125	25	-10	0					
SCLCR/S 004 ISO	✓	✓	8	11	6	100	25	-10	0					
SCLCR/S 005 ISO	✓	✓	12	16	9	150	30	-8	0					
SCLCR/S 006 ISO	✓	✓	16	20	11	180	35	-8	0	CC.T 09T3..			M2,5X7	T15
SCLCR/S 007 ISO	✓	✓	16	20	11	180	35	-8	0					
SCLCR/S 008 ISO	✓	✓	20	25	13	200	40	-8	0					
SCLCR/S 009 ISO	✓	✓	25	32	17	250	50	-8	0					
SCLCR/S 010 ISO	✓	✓	32	40	23	300	60	-8	0					
SCLCR/S 011 ISO	✓	✓	25	32	17	250	50	-8	0	CC.T 1204..	CC..12	M6XM4	M4X14	T20
SCLCR/S 012 ISO	✓	✓	32	40	23	300	60	-8	0					
SCLCR/S 013 ISO	✓	X	40	50	27	400	70	-8	0					

► STFCR ISO

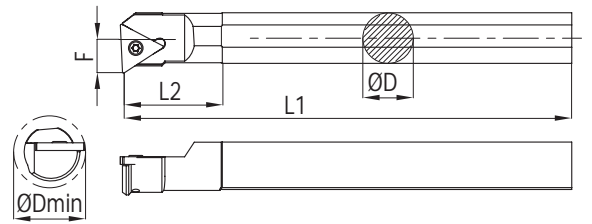

Kesici Uç Uyumluluğu Insert Suitability		Stok Stock												
ISO	R	L	D	D min	F	L1	L2	λF	YP	Uç Insert	Altık Shim	Vida Screw	Vida Screw	Anahtar Torx Key
STFCR/S 001 ISO	✓	✓	16	20	11	180	35	-9	0	TC.T 16T3..	-	-	M3.5X8	T15
STFCR/S 002 ISO	✓	✓	20	25	13	200	40	-8	0					
STFCR/S 003 ISO	✓	✓	25	32	17,5	250	50	-8	0					
STFCR/S 004 ISO	✓	✓	32	40	23	300	60	-8	0					
											TC..016	M5X0.5XM3.5	M3.5X11	



► CKUNR ISO

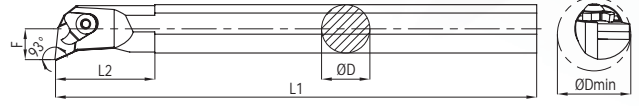

Kesici Uç Uyumluluğu Insert Suitability		Stok Stock													
ISO	R	L	D	D min	F	L1	L2	λF	YP	Uç Insert	Altık Shim	Vida Screw	Pabuç Clamp	Vida Screw	Anahtar Allen Key
CKUNR 002 ISO	✓	✓	25	32	17	250	50	-12	-5	KNUX 1604..	KN..016 (R/L)	M3X8 A2.5	C160105	M6X27	A3
CKUNR 003 ISO	✓	✓	32	40	22	300	60	-12	-5						
CKUNR 004 ISO	✓	✓	40	50	27	400	65	-9	-5						
CKUNR 005 ISO	✓	X	50	63	35	450	70	-7	-5						
CKUNR 006 ISO	✓	X	60	75	35	450	70	-7	-5						

► CTUPR ISO

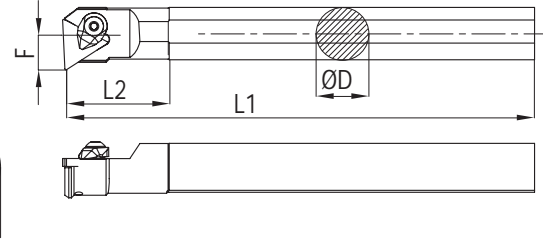



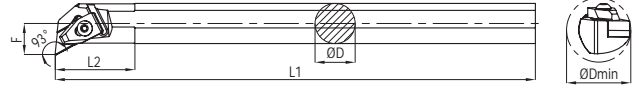

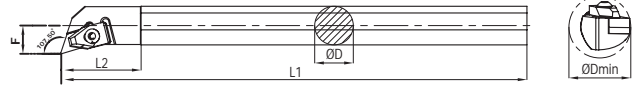

Kesici Uç Uyumluluğu Insert Suitability		Stok Stock													
ISO	R	L	D	D min	F	L1	L2	λF	YP	Uç Insert	Altık Shim	Vida Screw	Pabuç Clamp	Vida Screw	Anahtar Allen Key
CTUPR 002 ISO	✓	X	20	25	13	200	40	-8	-	TPKN 1603	TP..16	M4x10	C160105	M5X23	A3
CTUPR 003 ISO	✓	X	25	32	17	250	50	-8	-						

► TDUNR ISO

Kesici Uç Uyumluluğu Insert Suitability		Stok Stock													
ISO	R	L	D	D min	F	L1	L2	λF	YP	Uç Insert	Altılık Shim	Vida Screw	Pabuç Clamp	Vida Screw	Anahtar Allen Key
TDUNR 001 ISO	✓	✓	20	25	13	200	40	-11	-5	DNM. 1104..	-	-	T110105	M5X15	A3
TDUNR 002 ISO	✓	✓	25	32	17	250	50	-13	-5	DNM. 1506..	DN..015	M4X8 A2.5	T150105	M6X20	
TDUNR 003 ISO	✓	✓	32	40	22	300	60	-12	-5					M6X27	
TDUNR 004 ISO	✓	✓	40	50	27	400	70	-12	-5						
TDUNR 005 ISO	✓	✓	50	63	35	450	75	-12	-5						
TDUNR 006 ISO	✓	X	60	75	40	450	75	-12	-5						

► TDQNR ISO

Kesici Uç Uyumluluğu Insert Suitability		Stok Stock													
ISO	R	L	D	D min	F	L1	L2	λF	YP	Uç Insert	Altılık Shim	Vida Screw	Pabuç Clamp	Vida Screw	Anahtar Allen Key
TDQNR 000 ISO	✓	X	25	32	17	250	50	-13	-5	DNM. 1506..	DN..015	M4X8 A2.5	T150105	M6X20	A3
TDQNR 001 ISO	✓	X	32	40	22	300	60	-12	-5					M6X27	
TDQNR 002 ISO	✓	X	40	50	27	400	70	-12	-5						
TDQNR 003 ISO	✓	X	50	63	35	450	75	-12	-5						

► TD-NR ISO

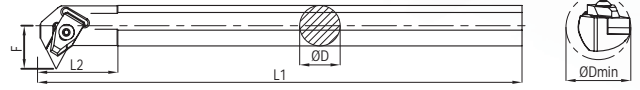

Kesici Uç Uyumluluğu Insert Suitability		Stok Stock													
ISO	R	L	D	D min	F	L1	L2	λF	YP	Uç Insert	Altık Shim	Vida Screw	Pabuç Clamp	Vida Screw	Anahtar Allen Key
TD-NR 001 ISO	✓	X	32	43	26,5	300	60	-15	0	DNM. 1506..	DN..015	M4X8 A2,5	T150105	M6X27	A3
TD-NR 002 ISO	✓	X	40	50	29,5	400	70	-13	0						
TD-NR 003 ISO	✓	X	50	62	35	450	70	-13	0						



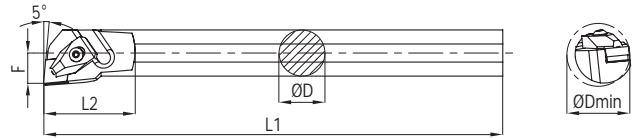



► TCLNR ISO

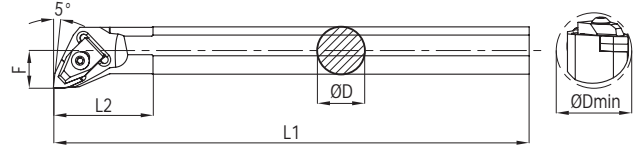

Kesici Uç Uyumluluğu Insert Suitability		Stok Stock													
ISO	R	L	D	D min	F	L1	L2	λF	YP	Uç Insert	Altık Shim	Vida Screw	Pabuç Clamp	Vida Screw	Anahtar Allen Key
TCLNR/S 001 ISO	✓	✓	25	32	17	250	50	-12	-5	CNM. 1204..	CN..012	M4X8 A2,5	T120105	M6X20	A3
TCLNR/S 002 ISO	✓	✓	32	40	22	300	60	-12	-5						
TCLNR/S 003 ISO	✓	X	40	50	27	400	70	-12	-5	CNM. 1606..	CN..016	M5X8 A3	T160105		
TCLNR/S 004 ISO	✓	X	50	63	35	450	75	-12	-5						
TCLNR/S 005 ISO	✓	✓	32	40	22	300	60	-12	-5	CNM. 1204..	CN..012	M4X8 A2,5	T120105		
TCLNR/S 006 ISO	✓	X	40	40	27	400	70	-12	-5						
TCLNR/S 007 ISO	✓	X	60	75	40	450	75	-12	-5	CNM. 1606..	CN..016	M5X8 A3	T160105		

► TWLNR ISO



Kesici Uç Uyumluluğu Insert Suitability		Stok Stock													
ISO	R	L	D	D min	F	L1	L2	λF	YP	Uç Insert	Altık Shim	Vida Screw	Pabuç Clamp	Vida Screw	Anahtar Allen Key
TWLNR/S 001 ISO	✓	X	16	20	11	180	35	-11	-5	WNM. 0602..	-	-	T060105	M5X15	A3
TWLNR/S 002 ISO	✓	✓	20	25	13	200	40	-11	-5					M6X20	
TWLNR/S 003 ISO	✓	✓	25	32	17	250	50	-13	-5					M6X20	
TWLNR/S 004 ISO	✓	✓	32	40	22	300	60	-12	-5					M6X20	
TWLNR/S 005 ISO	✓	X	40	50	27	400	70	-12	-5	WNM. 0804..	WN.008(H)	M4X8 A2.5	T080105	M6X27	
TWLNR/S 006 ISO	✓	X	50	63	35	450	75	-12	-5					M6X27	
TWLNR/S 007 ISO	✓	X	60	75	40	450	75	-12	-5					M6X27	



► MTUNR ISO

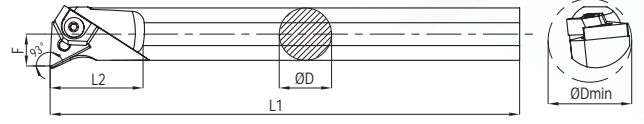





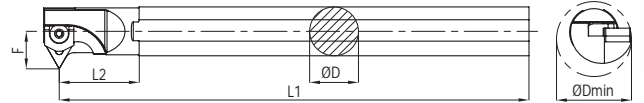

Kesici Uç Uyumluluğu Insert Suitability		Stok Stock													
ISO	R	L	D	D min	F	L1	L2	λF	YP	Uç Insert	Altık Shim	Altık Pimi Lock Pin	Pabuç Clamp	Vida Screw	Anahtar Allen Key
MTUNR 001 ISO	✓	✓	20	25	13	200	40	-13	-5	TNM. 1604..	-	-	M160105	M5X15	A3
MTUNR 002 ISO	✓	✓	25	32	17	250	50	-12	-5						
MTUNR 003 ISO	✓	✓	32	40	22	300	60	-12	-5						
MTUNR 004 ISO	✓	✓	40	50	27	400	70	-12	-5						
MTUNR 005 ISO	✓	✓	32	40	22	300	60	-12	-5	TNM. 2204..	TN..016(P)	5X3.6X12.5	M160105	M5X23	
MTUNR 006 ISO	✓	✗	40	50	27	400	70	-12	-5						
MTUNR 007 ISO	✓	✗	50	63	35	450	75	-12	-5						
MTUNR 008 ISO	✓	✗	60	75	40	450	75	-12	-5						

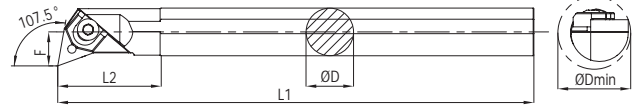
► MT-NR ISO







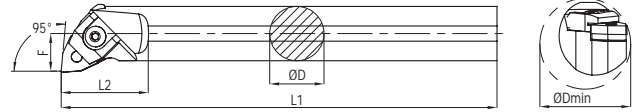

Kesici Uç Uyumluluğu Insert Suitability		Stok Stock													
ISO	R	L	D	D min	F	L1	L2	λF	YP	Uç Insert	Altık Shim	Altık Pimi Lock Pin	Pabuç Clamp	Vida Screw	Anahtar Allen Key
MT-NR 001 ISO	✓	✓	20	27	16	200	40	-15	0	TNM. 1604..	-	-	M160105	M5X15	A3
MT-NR 002 ISO	✓	✓	25	33	19,5	250	50	-14	0						
MT-NR 003 ISO	✓	✓	32	40	23	300	55	-13	0						
MT-NR 004 ISO	✓	✓	40	50	29,5	400	70	-15	0						
MT-NR 005 ISO	✓	✗	50	62	35	450	70	-15	0						

► **MTQNR ISO**

Kesici Uç Uyumluluğu Insert Suitability		Stok Stock													
ISO	R	L	D	D min	F	L1	L2	λF	YP	Uç Insert	Altık Shim	Altık Pimi Lock Pin	Pabuç Clamp	Vida Screw	Anahtar Allen Key
MTQNR 001 ISO	✓	X	20	25	13	200	40	-13	-5	TNM. 1604..	-	-	M160105	M5X15	A3
MTQNR 002 ISO	✓	X	25	32	17	250	50	-12	-5		TN..016(P)	5X3.6X15		M5X23	
MTQNR 003 ISO	✓	X	32	40	22	300	60	-11	-5						
MTQNR 004 ISO	✓	X	40	50	27	400	70	-11	-5	TNM. 2204..	TN..022(P)	6X5X18	M220105	M6X27	
MTQNR 005 ISO	✓	X	32	40	22	300	60	-11	-5						
MTQNR 006 ISO	✓	X	40	50	27	400	70	-11	-5						



► **MWLNR ISO**

Kesici Uç Uyumluluğu Insert Suitability		Stok Stock													
ISO	R	L	D	D min	F	L1	L2	λF	YP	Uç Insert	Altık Shim	Altık Pimi Lock Pin	Pabuç Clamp	Vida Screw	Anahtar Allen Key
MWLNR/S 001 ISO	✓	X	16	20	11	180	-5	-13	-5	WNM. 0604..	-	5x3,6x15	M060105	M5X15	A3
MWLNR/S 002 ISO	✓	X	20	25	13	200	-5	-13	-5					M6X20	
MWLNR/S 003 ISO	✓	✓	25	32	17	250	-5	-13	-5						
MWLNR/S 004 ISO	✓	✓	32	40	22	300	-5	-12	-5	WNM. 0804..	WN..008	6x5x15	M080105	M6X27	
MWLNR/S 005 ISO	✓	✓	40	50	27	400	-5	-14	-5						
MWLNR/S 006 ISO	✓	X	50	63	35	450	-5	-12	-5						
MWLNR/S 007 ISO	✓	X	60	75	40	450	-5	-12	-5						

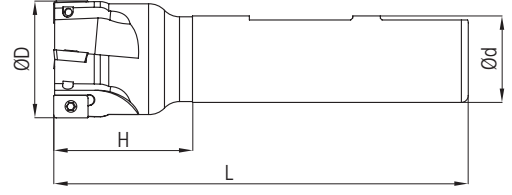

▶ APKT 1003 ISO



Kesici Uç Uyumluluğu Insert Suitability	Stok Stock	Inter Cooland	D	Z	H	L	d	  		
								Uç Insert	Vida Screw	Anahtar Torx Key
ISO AP..1003										
ST AP..10 001 ISO	✓	✓	12	1	30	120	12	AP..1003..	M2.5X6	T08
ST AP..10 002 ISO	✓	✗	14	1	30	120	12		M2.5X6	
ST AP..10 003 ISO	✓	✓	16	2	30	100	16		M2.5X6	
ST AP..10 004 ISO	✓	✗	16	2	30	120	16		M2.5X6	
ST AP..10 005 ISO	✓	✓	16	2	40	150	16		M2.5X6	
ST AP..10 006 ISO	✓	✗	16	2	50	200	16		M2.5X6	
ST AP..10 007 ISO	✓	✓	16	2	50	250	16		M2.5X6	
ST AP..10 008 ISO	✓	✗	18	2	30	100	16		M2.5X6	
ST AP..10 009 ISO	✓	✓	18	2	30	120	16		M2.5X6	
ST AP..10 010 ISO	✓	✗	18	2	40	150	16		M2.5X6	
ST AP..10 011 ISO	✓	✗	18	2	50	200	16		M2.5X6	
ST AP..10 012 ISO	✓	✓	20	3	30	100	20		M2.5X7	
ST AP..10 013 ISO	✓	✗	20	3	30	120	20		M2.5X7	
ST AP..10 014 ISO	✓	✓	18	2	50	250	16		M2.5X6	
ST AP..10 015 ISO	✓	✗	20	3	40	150	20		M2.5X7	
ST AP..10 016 ISO	✓	✓	20	3	60	200	20		M2.5X7	
ST AP..10 017 ISO	✓	✗	20	3	70	250	20		M2.5X7	
ST AP..10 018 ISO	✓	✓	22	3	30	100	20		M2.5X7	
ST AP..10 019 ISO	✓	✗	22	3	30	120	20		M2.5X7	
ST AP..10 020 ISO	✓	✗	22	3	40	150	20		M2.5X7	
ST AP..10 021 ISO	✓	✓	22	3	50	200	20		M2.5X7	
ST AP..10 022 ISO	✓	✗	22	3	50	250	20		M2.5X7	
ST AP..10 023 ISO	✓	✓	25	3	30	100	25		M2.5X7	
ST AP..10 024 ISO	✓	✗	25	3	30	120	25		M2.5X7	
ST AP..10 025 ISO	✓	✓	25	3	40	150	25		M2.5X7	
ST AP..10 026 ISO	✓	✗	25	3	60	200	25		M2.5X7	
ST AP..10 027 ISO	✓	✓	25	3	70	250	25		M2.5X7	

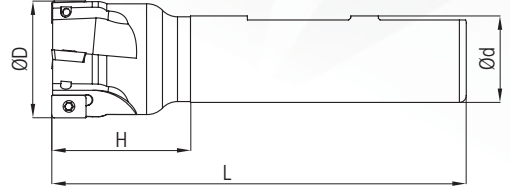

► APKT 1003 ISO

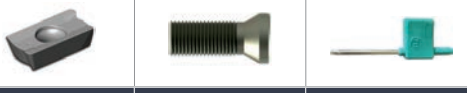

Kesici Uç Uyumluluğu Insert Suitability	Stok Stock	Inter Cooland	D	Z	H	L	d			
								Uç Insert	Vida Screw	Anahtar Torx Key
ISO AP..1003										
ST AP..10 028 ISO	✓	✗	28	4	35	150	25	AP..1003..	M2.5X7	T08
ST AP..10 029 ISO	✓	✗	26	3	35	150	25		M2.5X7	
ST AP..10 030 ISO	✓	✓	26	3	35	200	25		M2.5X7	
ST AP..10 031 ISO	✓	✗	26	3	35	250	25		M2.5X7	
ST AP..10 032 ISO	✓	✓	30	4	30	100	25		M2.5X7	
ST AP..10 033 ISO	✓	✗	30	4	30	120	25		M2.5X7	
ST AP..10 034 ISO	✓	✓	30	3	40	150	25		M2.5X7	
ST AP..10 035 ISO	✓	✗	30	4	40	150	25		M2.5X7	
ST AP..10 036 ISO	✓	✗	30	4	40	200	25		M2.5X7	
ST AP..10 037 ISO	✓	✗	30	3	40	300	25		M2.5X7	
ST AP..10 038 ISO	✓	✓	32	4	40	150	25		M2.5X7	
ST AP..10 039 ISO	✓	✗	32	4	60	150	32		M2.5X7	
ST AP..10 040 ISO	✓	✓	32	4	60	200	32		M2.5X7	
ST AP..10 041 ISO	✓	✗	35	4	30	100	25		M2.5X7	
ST AP..10 042 ISO	✓	✓	35	4	30	120	25		M2.5X7	
ST AP..10 043 ISO	✓	✗	35	4	30	150	25		M2.5X7	
ST AP..10 044 ISO	✓	✓	35	4	30	200	25		M2.5X7	
ST AP..10 045 ISO	✓	✗	35	4	35	100	32		M2.5X7	
ST AP..10 046 ISO	✓	✗	35	4	35	120	32		M2.5X7	
ST AP..10 047 ISO	✓	✗	35	4	35	150	32		M2.5X7	
ST AP..10 048 ISO	✓	✗	40	5	40	100	25		M2.5X7	
ST AP..10 049 ISO	✓	✗	40	5	40	120	25		M2.5X7	
ST AP..10 050 ISO	✓	✗	40	5	40	150	25		M2.5X7	
ST AP..10 051 ISO	✓	✗	40	5	40	200	25		M2.5X7	
ST AP..10 053 ISO	✓	✗	40	5	40	100	32		M2.5X7	
ST AP..10 054 ISO	✓	✓	40	5	40	120	32		M2.5X7	
ST AP..10 055 ISO	✓	✗	40	5	40	150	32		M2.5X7	

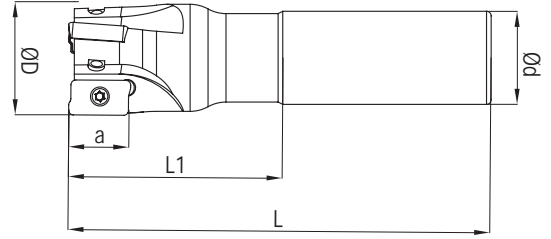

▶ APKT 1604 ISO



Kesici Uç Uyumluluğu Insert Suitability	Stok Stock	Inter Cooland	D	Z	H	L	d	  		
								Uç Insert	Vida Screw	Anahtar Torx Key
AP..1604..										
ST AP..16 001 ISO	✓	✓	25	2	37	100	25	M3.5X8	AP..1604..	T15
ST AP..16 002 ISO	✓	✗	25	2	41	120	25			
ST AP..16 003 ISO	✓	✓	25	2	50	150	25			
ST AP..16 004 ISO	✓	✗	25	2	70	200	25			
ST AP..16 005 ISO	✓	✓	25	2	70	250	25			
ST AP..16 006 ISO	✓	✗	25	2	70	300	25			
ST AP..16 007 ISO	✓	✓	30	3	41	100	25			
ST AP..16 008 ISO	✓	✗	30	3	41	120	25			
ST AP..16 009 ISO	✓	✗	30	3	41	150	25			
ST AP..16 010 ISO	✓	✗	30	3	41	200	25			
ST AP..16 011 ISO	✓	✗	30	3	41	250	25			
ST AP..16 012 ISO	✓	✓	30	3	41	300	25			
ST AP..16 013 ISO	✓	✗	32	3	41	100	25			
ST AP..16 014 ISO	✓	✓	32	3	41	120	25			
ST AP..16 015 ISO	✓	✗	32	3	41	150	25			
ST AP..16 016 ISO	✓	✓	32	3	41	200	25			
ST AP..16 017 ISO	✓	✗	32	3	35	100	32			
ST AP..16 018 ISO	✓	✓	32	3	35	120	32			
ST AP..16 019 ISO	✓	✗	32	3	50	150	32			
ST AP..16 020 ISO	✓	✗	32	3	60	200	32			
ST AP..16 021 ISO	✓	✗	32	3	70	250	32			
ST AP..16 022 ISO	✓	✓	32	3	70	300	32			
ST AP..16 023 ISO	✓	✗	32	3	100	350	32			
ST AP..16 024 ISO	✓	✓	35	3	41	100	25			
ST AP..16 025 ISO	✓	✗	35	3	41	120	25			
ST AP..16 026 ISO	✓	✓	35	3	55	150	25			
ST AP..16 027 ISO	✓	✗	35	3	41	100	32			
ST AP..16 028 ISO	✓	✓	35	3	41	120	32			
ST AP..16 029 ISO	✓	✗	35	3	41	150	32			
ST AP..16 030 ISO	✓	✓	35	3	41	200	32			
ST AP..16 031 ISO	✓	✗	35	3	41	250	32			
ST AP..16 032 ISO	✓	✓	35	3	41	300	32			
ST AP..16 033 ISO	✓	✗	35	3	41	350	32			
ST AP..16 034 ISO	✓	✗	40	4	41	100	25			
ST AP..16 035 ISO	✓	✓	40	4	41	120	25			
ST AP..16 036 ISO	✓	✓	40	4	41	150	25			
ST AP..16 037 ISO	✓	✗	40	4	41	200	25			
ST AP..16 038 ISO	✓	✗	40	4	46	100	32			
ST AP..16 039 ISO	✓	✗	40	4	46	120	32			
ST AP..16 040 ISO	✓	✗	40	4	46	150	32			
ST AP..16 041 ISO	✓	✓	40	4	46	200	32			
ST AP..16 042 ISO	✓	✗	40	4	46	250	32			
ST AP..16 043 ISO	✓	✓	40	4	46	300	32			
ST AP..16 044 ISO	✓	✗	40	4	46	350	32			

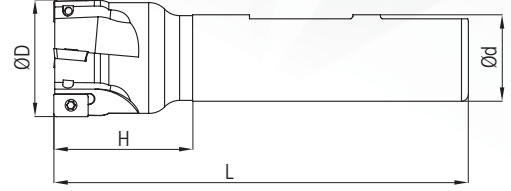

► APMT 11T3 ?

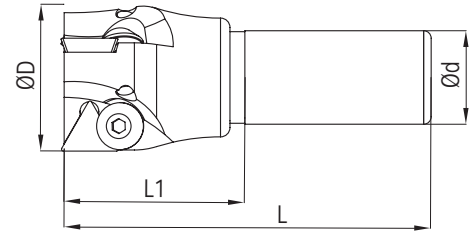

Kesici Uç Uyumluluğu Insert Suitability	Stok Stock	Inter Cooland	D	Z	L1	L	d			
								Uç Insert	Vida Screw	Anahtar Torx Key
APMT 11T3..										
ST APMT 11 001	✓	X	16	2	30	90	16	APMT 11T3..	M2.5X6	T08
ST APMT 11 020	✓	X	16	2	30	120	16			
ST APMT 11 021	✓	X	16	2	30	150	16			
ST APMT 11 004	✓	X	17	2	30	120	16			
ST APMT 11 005	✓	X	17	2	30	200	16			
ST APMT 11 006	✓	X	18	2	30	100	16			
ST APMT 11 007	✓	X	18	2	30	120	16			
ST APMT 11 008	✓	X	20	3	30	120	20			
ST APMT 11 009	✓	X	20	3	40	150	20			
ST APMT 11 010	✓	X	21	3	40	120	20			
ST APMT 11 011	✓	X	21	3	40	140	20			
ST APMT 11 012	✓	X	22	3	40	120	20			
ST APMT 11 013	✓	X	22	3	40	150	20			
ST APMT 11 014	✓	X	25	3	40	150	25			
ST APMT 11 015	✓	X	25	3	40	150	25			
ST APMT 11 016	✓	X	25	3	50	200	25			
ST APMT 11 017	✓	X	30	4	30	120	25			
ST APMT 11 018	✓	X	30	4	40	150	25			
ST APMT 11 019	✓	X	32	4	50	200	32			
									M2.5X7	

► TPKN 1603 ISO



Kesici Uç Uyumluluğu Insert Suitability	Stok Stock	Inter Cooland	D	Z	L1	L	d			
								Uç Insert	Vida Screw	Anahtar Torx Key
ISO										
ST TPKN 16 001 ISO	✓	X	35	2	50	100	25	TPKN 1603	M6X0,75	A4
ST TPKN 16 002 ISO	✓	X	40	3	50	100	25			
ST TPKN 16 003 ISO	✓	X	50	3	50	100	25			

► XO.. 0903 SCO

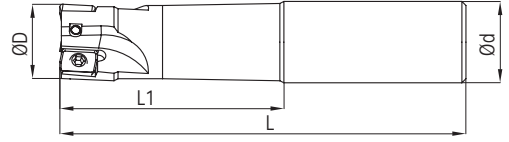

Kesici Uç Uyumluluğu Insert Suitability	Stok Stock	Inter Cooland	D	Z	L1	L	d	Uç Insert	Vida Screw	Anahtar Torx Key
SCO XO..0903..										
ST XO..09 001 SCO	✓	✗	16	2	30	100	16	XO..0903..	M2.5X8	T08
ST XO..09 002 SCO	✓	✗	16	2	30	130	16			
ST XO..09 003 SCO	✓	✗	16	2	40	150	16			
ST XO..09 004 SCO	✓	✗	16	2	50	200	16			
ST XO..09 005 SCO	✓	✗	20	3	30	120	20			
ST XO..09 006 SCO	✓	✗	20	3	40	150	20			
ST XO..09 007 SCO	✓	✗	20	3	50	200	20			
ST XO..09 008 SCO	✓	✗	25	3	50	150	25			

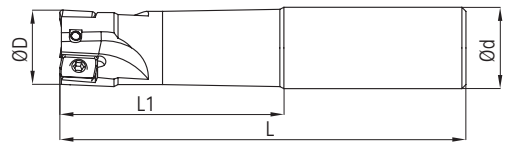

► XOMX 1204 SCO



Kesici Uç Uyumluluğu Insert Suitability	Stok Stock	Inter Cooland	D	Z	L1	L	d	Uç Insert	Vida Screw	Anahtar Torx Key
SCO XOMX 1204..										
ST XOMX 12 001 SCO	✓	✗	16	1	30	120	16	XOMX 1204..	M3,5X6	T15
ST XOMX 12 002 SCO	✓	✗	16	1	40	150	16			
ST XOMX 12 003 SCO	✓	✗	20	2	30	100	20			
ST XOMX 12 004 SCO	✓	✗	20	2	40	120	20			
ST XOMX 12 005 SCO	✓	✗	20	2	50	150	20			
ST XOMX 12 006 SCO	✓	✗	22	2	30	150	20			
ST XOMX 12 007 SCO	✓	✗	25	3	40	120	25			
ST XOMX 12 008 SCO	✓	✗	25	3	50	150	25			
ST XOMX 12 009 SCO	✓	✗	32	4	30	150	25			

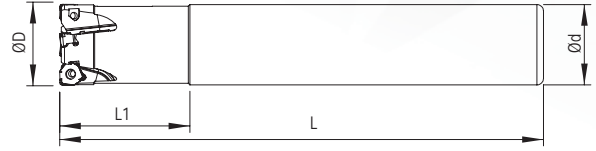

► XNMX 0403 SCO





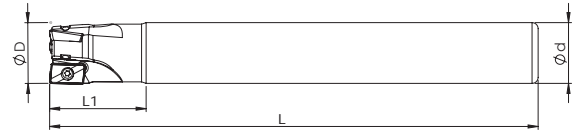

Kesici Uç Uyumluluğu Insert Suitability	Stok Stock	Inter Cooland	D	Z	L1	L	d			
								Uç Insert	Vida Screw	Anahtar Torx Key
SCO XNMX 0403										
ST XNMX 04 001 SCO	✓	✓	18	2	35	150	16	XNMX 0403	M2.5x6	T08
ST XNMX 04 002 SCO	✓	✓	18	2	35	200	16			
ST XNMX 04 003 SCO	✓	✓	20	3	40	150	20			
ST XNMX 04 004 SCO	✓	✓	21	3	35	150	20			
ST XNMX 04 005 SCO	✓	✓	21	3	35	200	20			
ST XNMX 04 006 SCO	✓	✓	25	4	40	150	25			
ST XNMX 04 007 SCO	✓	✓	26	4	40	150	25			
ST XNMX 04 008 SCO	✓	✓	32	4	40	150	32			

► APKT 11T3 ZCC

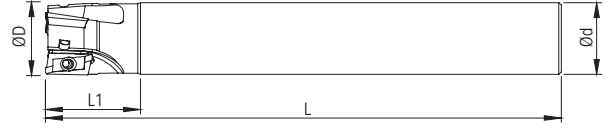



Kesici Uç Uyumluluğu Insert Suitability	Stok Stock	Inter Cooland	D	Z	L1	L	d			
								Uç Insert	Vida Screw	Anahtar Torx Key
ZCC APKT 11T3										
ST APKT 11 001 ZCC	✓	✓	16	2	40	160	16	APKT 11T3	M2.5x6	T08
ST APKT 11 002 ZCC	✓	✓	16	2	50	200	16			
ST APKT 11 003 ZCC	✓	✓	17	2	30	160	16			
ST APKT 11 004 ZCC	✓	✓	17	2	30	200	16			
ST APKT 11 005 ZCC	✓	✓	17	2	30	250	16			
ST APKT 11 006 ZCC	✓	✓	18	2	30	160	16			
ST APKT 11 007 ZCC	✓	✓	20	3	40	160	20			
ST APKT 11 008 ZCC	✓	✓	21	3	30	160	20			
ST APKT 11 009 ZCC	✓	✓	21	3	30	200	20			
ST APKT 11 010 ZCC	✓	✓	21	3	30	250	20			
ST APKT 11 011 ZCC	✓	✓	25	3	40	160	25			
ST APKT 11 012 ZCC	✓	✓	26	3	30	150	25			
ST APKT 11 013 ZCC	✓	✓	26	3	30	200	25			
ST APKT 11 014 ZCC	✓	✓	26	3	30	250	25			

► APKT 1604 ZCC

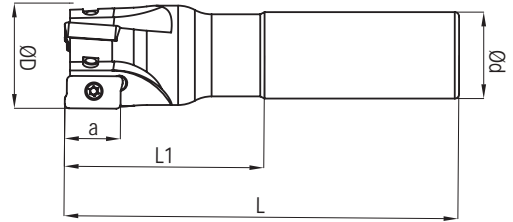



Kesici Uç Uyumluluğu Insert Suitability	Stok Stock	Inter Cooland	D	Z	L1	L	d	Uç Insert	Vida Screw	Anahtar Torx Key
ZCC APKT 1604..										
ST APKT 16 001 ZCC	✓	✓	25	2	50	170	25	APKT 1604..	M4X9	T15
ST APKT 16 002 ZCC	✓	✓	26	2	35	200	25			
ST APKT 16 003 ZCC	✓	✓	32	3	50	170	32			
ST APKT 16 026 ZCC	✓	✓	33	3	35	200	32			
ST APKT 16 027 ZCC	✓	X	33	3	35	250	32			
ST APKT 16 028 ZCC	✓	X	33	3	35	300	32			
ST APKT 16 029 ZCC	✓	X	33	3	35	400	32			

► ADMT 1204 WLTR

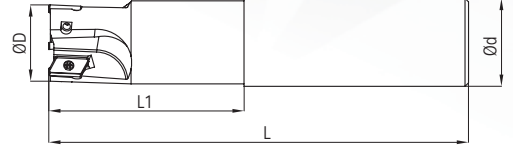
Kesici Uç Uyumluluğu Insert Suitability	Stok Stock	Inter Cooland	D	Z	L1	L	d	Uç Insert	Vida Screw	Anahtar Torx Key
WLTR ADMT 1204										
ST ADMT 12 001 WLTR	✓	X	20	2	45	120	20	ADMT 1204..	M3X9	T10
ST ADMT 12 002 WLTR	✓	X	20	2	50	150	20			
ST ADMT 12 003 WLTR	✓	X	25	3	45	120	25			
ST ADMT 12 004 WLTR	✓	X	25	3	55	150	25			
ST ADMT 12 005 WLTR	✓	X	30	3	40	120	25			
ST ADMT 12 006 WLTR	✓	X	30	3	40	150	25			
ST ADMT 12 007 WLTR	✓	X	32	4	60	150	32			
ST ADMT 12 008 WLTR	✓	X	40	4	40	120	32			
ST ADMT 12 009 WLTR	✓	X	40	4	40	150	32			



► ADMT 10T3 WLTR



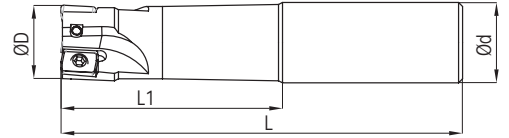

Kesici Uç Uyumluluğu Insert Suitability	Stok Stock	Inter Cooland	D	Z	L1	L	d	Uç Insert	Vida Screw	Anahtar Torx Key
WLTR ADMT 10T3..										
ST ADMT 10 001 WLTR	X	X	16	2	25	90	16	ADMT 10T3..	M2.5X6	T08
ST ADMT 10 002 WLTR	X	X	20	3	35	120	20			
ST ADMT 10 003 WLTR	X	X	25	3	35	120	25			

► AP.. 0903 WLTR





Kesici Uç Uyumluluğu Insert Suitability	Stok Stock	Inter Cooland	D	Z	L1	L	d	Uç Insert	Vida Screw	Anahtar Torx Key
WLTR AP..0903										
ST AP..09 001 WLTR	✓	X	16	2	30	100	16	AP..0903..	M2.5X8	T08
ST AP..09 002 WLTR	✓	X	16	2	30	130	16			
ST AP..09 003 WLTR	✓	X	16	2	40	150	16			
ST AP..09 004 WLTR	✓	X	16	2	50	200	16			
ST AP..09 005 WLTR	✓	X	20	3	30	120	20			
ST AP..09 006 WLTR	✓	X	20	3	40	150	20			
ST AP..09 007 WLTR	✓	X	20	3	50	200	20			

▶ ADMT 0803 WLTR

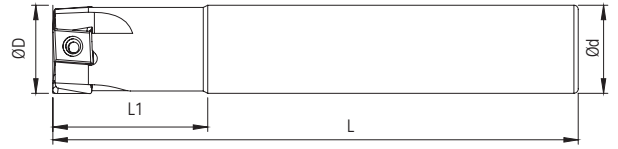
Kesici Uç Uyumluluğu Insert Suitability		Stok Stock									
WLTR ADMT 0803			Inter Cooland	D	Z	L1	L	d	Uç Insert	Vida Screw	Anahtar Torx Key
ST	ADMT 08 001 WLTR	✓	✓	16	2	44	150	16	ADMT 0803..	M2,5x6	T08
ST	ADMT 08 002 WLTR	✓	✓	20	2	55	200	16			
ST	ADMT 08 003 WLTR	✓	✓	20	3	55	150	20			
ST	ADMT 08 004 WLTR	✓	✓	20	3	61	200	20			
ST	ADMT 08 005 WLTR	✓	✓	26	3	35	150	25			
ST	ADMT 08 006 WLTR	✓	✓	26	3	35	200	25			

▶ LNHU 0904 WLTR

Kesici Uç Uyumluluğu Insert Suitability		Stok Stock									
WLTR LNHU 0904			Inter Cooland	D	Z	L1	L	d	Uç Insert	Vida Screw	Anahtar Torx Key
ST	LNHU 09 001 WLTR	✓	✓	20	3	35	120	20	LNHU 0904	M3x10	T10
ST	LNHU 09 002 WLTR	✓	✓	20	3	35	150	20			
ST	LNHU 09 003 WLTR	✓	✓	25	4	40	120	25			
ST	LNHU 09 004 WLTR	✓	✓	25	4	45	150	25			
ST	LNHU 09 005 WLTR	✓	✓	32	5	40	120	32			

► ANGX 1135 ZCC

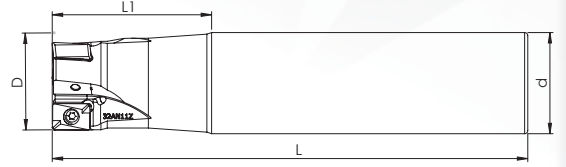



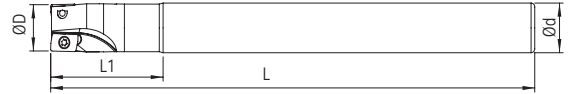

Kesici Uç Uyumluluğu Insert Suitability	Stok Stock	Inter Cooland	D	Z	L1	L	d	Uç Insert	Vida Screw	Anahtar Torx Key
ZCC ANGX 1135										
ST ANGX 11 001 ZCC	✓	✓	25	2	50	150	25	ANGX 1135..	M3X8	T10
ST ANGX 11 002 ZCC	✗	✓	32	3	50	150	32			
ST ANGX 11 003 ZCC	✗	✓	40	4	50	150	32			

► APKT 0702 ZCC

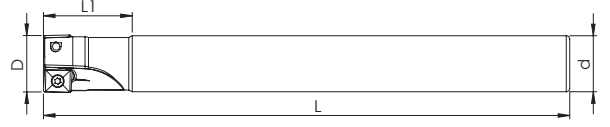



Kesici Uç Uyumluluğu Insert Suitability	Stok Stock	Inter Cooland	D	Z	L1	L	d	Uç Insert	Vida Screw	Anahtar Torx Key
ZCC APKT 0702										
ST AP..07 001 ZCC	✓	✗	10	2	30	130	10	APKT 0702	M1,8x3,5	T06
ST AP..07 002 ZCC	✓	✗	12	2	30	130	10			
ST AP..07 003 ZCC	✓	✗	12	2	30	130	12			
ST AP..07 004 ZCC	✓	✗	14	3	30	130	12			
ST AP..07 005 ZCC	✓	✗	16	3	30	150	14			

► LPGT 0702 WLTR

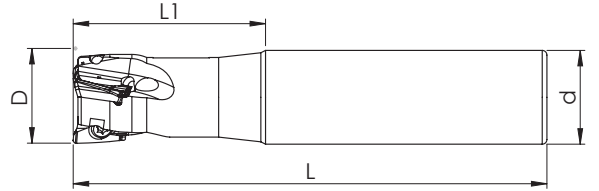
Kesici Uç Uyumluluğu Insert Suitability		Stok Stock									
WLTR LPGT 0702			Inter Cooland	D	Z	L1	L	d	Uç Insert	Vida Screw	Anahtar Torx Key
ST LPGT 07 001 WLTR	✓		X	17	2	25	150	16	LPGT 0702..	M2.5X6	T8
ST LPGT 07 002 WLTR	✓		X	21	3	30	150	20			
ST LPGT 07 003 WLTR	✓		X	26	4	30	150	25			

► AXMT 1235 SMTM

Kesici Uç Uyumluluğu Insert Suitability		Stok Stock									
SMTM AXMT 1235			Inter Cooland	D	Z	L1	L	d	Uç Insert	Vida Screw	Anahtar Torx Key
ST AXMT 12 001 SMTM	✓		X	12	1	30	100	12	AXMT 1235..	M3X6	T10
ST AXMT 12 002 SMTM	✓		X	14	1	30	100	12			
ST AXMT 12 003 SMTM	✓		X	16	1	30	100	16			
ST AXMT 12 004 SMTM	✓		X	18	2	35	100	16			
ST AXMT 12 005 SMTM	✓		X	20	3	40	100	20			

► AXMT 0602 SMTM

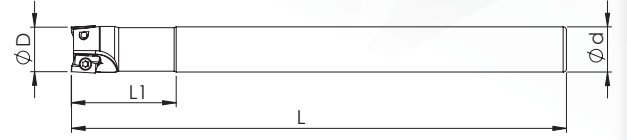

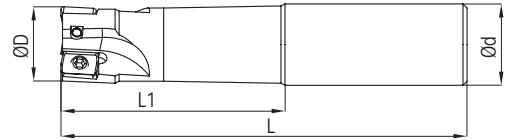

Kesici Uç Uyumluluğu Insert Suitability	Stok Stock	Inter Cooland	D	Z	L1	L	d	Uç Insert	Vida Screw	Anahtar Torx Key
SMTM AXMT 0602										
ST AXMT 06 001 SMTM	✓	×	10	2	15	75	10	AXMT 0602..	M1,8x3,5	T06
ST AXMT 06 002 SMTM	✓	×	12	2	20	120	12			
ST AXMT 06 003 SMTM	✓	×	12	3	20	90	12			
ST AXMT 06 004 SMTM	✓	×	14	3	25	100	16			

► APKT 1003 PLBT



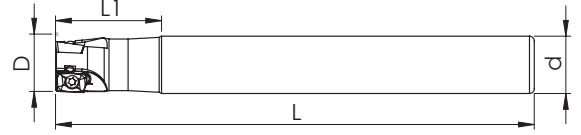

Kesici Uç Uyumluluğu Insert Suitability	Stok Stock	Inter Cooland	D	Z	H	L	d	Uç Insert	Vida Screw	Anahtar Torx Key
PLT APKT 1003..										
ST APKT 10 001 PLT	×	×	16	2	30	120	16	APKT 1003..	M2.5X6	T08
ST APKT 10 002 PLT	×	×	16	2	40	150	16		M2.5X7	
ST APKT 10 003 PLT	×	×	20	3	30	120	20		M2.5X8	
ST APKT 10 004 PLT	×	×	20	3	40	150	20			
ST APKT 10 005 PLT	×	×	25	3	30	120	25			
ST APKT 10 006 PLT	×	×	25	3	40	150	25			

► XPET 0602 PLBT

Kesici Uç Uyumluluğu Insert Suitability	Stok Stock	Inter Cooland	D	Z	L1	L	d			
PLBT XPET 0602								Uç Insert	Vida Screw	Anahtar Torx Key
ST XPET 06 001 PLBT	✓	✓	8	1	22	100	8	XPET 0602..	M1,8x3,5	T06
ST XPET 06 002 PLBT	✓	✓	8	1	25	120	8			
ST XPET 06 003 PLBT	✓	✓	10	2	22	120	9			
ST XPET 06 004 PLBT	✓	✓	10	2	22	100	10			
ST XPET 06 006 PLBT	✓	✓	12	3	22	100	12			
ST XPET 06 007 PLBT	✓	✓	12	3	22	100	11			
ST XPET 06 008 PLBT	✓	✓	12	3	22	120	12			
ST XPET 06 009 PLBT	✓	✓	14	3	18	140	12			
ST XPET 06 010 PLBT	✓	✓	16	4	20	160	12			

► LN.. 0804



Kesici Uç Uyumluluğu Insert Suitability	Stok Stock	Inter Cooland	D	Z	L1	L	d			
LN.. 0804								Uç Insert	Vida Screw	Anahtar Torx Key
ST LN..08 001	✓	X	16	2	30	120	16	LN.. 08	M2.5X6	T08
ST LN..08 002	✓	X	18	2	40	120	20		M2.5X7	
ST LN..08 003	✓	X	20	3	40	120	20		M2.5X8	
ST LN..08 004	✓	X	25	3	40	150	25			
ST LN..08 005	✓	X	25	4	40	150	25			
ST LN..08 006	✓	X	27	4	40	120	25			
ST LN..08 007	✓	X	30	4	37	200	25			

► AN.. 1205

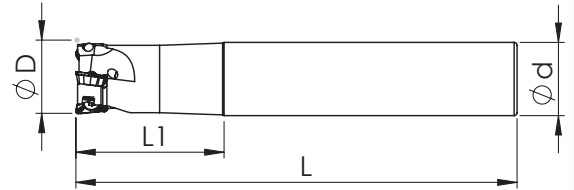

Kesici Uç Uyumluluğu Insert Suitability	Stok Stock	Inter Cooland	D	Z	L1	L	d	Uç Insert	Vida Screw	Anahtar Torx Key
AN.. 1205										
ST AN.. 12 001	✓	✓	30	2	35	120	25	AN.. 1205	M4X11	T15
ST AN.. 12 002	✓	✓	30	2	35	150	25			
ST AN.. 12 003	✓	✓	30	3	35	120	25			
ST AN.. 12 004	✓	✓	35	3	32	110	32			
ST AN.. 12 005	✓	✓	35	3	32	120	32			
ST AN.. 12 006	✓	✓	35	3	32	150	32			
ST AN.. 12 007	✓	✓	30	3	32	110	30			

► TP.. 1003



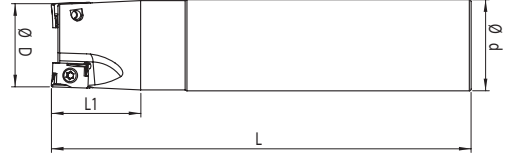

Kesici Uç Uyumluluğu Insert Suitability	Stok Stock	Inter Cooland	D	Z	L1	L	d	Uç Insert	Vida Screw	Anahtar Torx Key
TP.. 1003										
ST TP.. 10 001	✓	✓	25	3	40	120	25	TP.. 1003	M3,5X8	T15
ST TP.. 10 002	✓	✓	25	3	50	150	25			
ST TP.. 10 003	✓	✓	32	4	40	130	32			
ST TP.. 10 004	✓	✓	32	4	50	150	32			
ST TP.. 10 005	✓	✓	40	5	35	130	32			
ST TP.. 10 006	✓	✓	40	5	35	150	32			

► LNMX 1006 KRLY

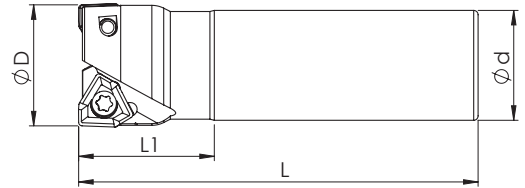
Kesici Uç Uyumluluğu Insert Suitability	Stok Stock	Inter Cooland	D	Z	L1	L	d			
KRLY LNMX 1006								Uç Insert	Vida Screw	Anahtar Torx Key
ST LNMX 10 000 KRLY	✓	✓	14	1	30	90	16	LNMX 1006	M3X8	T10
ST LNMX 10 001 KRLY	✓	✓	16	1	30	90	16			
ST LNMX 10 002 KRLY	✓	✓	18	2	30	90	16			
ST LNMX 10 003 KRLY	✓	✓	18	2	30	120	16			
ST LNMX 10 004 KRLY	✓	✓	20	2	30	150	18			
ST LNMX 10 005 KRLY	✓	✓	20	2	30	100	20			
ST LNMX 10 006 KRLY	✓	✓	20	2	50	150	20			
ST LNMX 10 007 KRLY	✓	✓	25	3	30	150	24			
ST LNMX 10 008 KRLY	✓	✓	25	2	30	115	25			
ST LNMX 10 009 KRLY	✓	✓	25	3	30	115	25			
ST LNMX 10 010 KRLY	✓	✓	25	3	50	150	25			
ST LNMX 10 011 KRLY	✓	✓	32	3	50	125	32			
ST LNMX 10 012 KRLY	✓	✓	32	4	50	125	32			
ST LNMX 10 013 KRLY	✓	✓	40	4	40	130	32			
ST LNMX 10 014 KRLY	✓	✓	40	5	40	130	32			
ST LNMX 10 015 KRLY	✓	✓	50	5	40	135	32			

► XNKT 0604 KRLY

Kesici Uç Uyumluluğu Insert Suitability	Stok Stock	Inter Cooland	D	Z	L1	L	d			
KRLY 060405 / 080508 XNKT								Uç Insert	Vida Screw	Anahtar Torx Key
ST XNKT 06 001 KRLY	✓	✓	18	2	30	150	20	XNKT 0604	M3x8	T10
ST XNKT 06 002 KRLY	✓	✓	20	2	30	150	20			
ST XNKT 06 003 KRLY	✓	✓	22	2	30	150	20			
ST XNKT 06 004 KRLY	✓	✓	25	3	50	150	25			
ST XNKT 06 005 KRLY	✓	✓	26	4	30	150	25			
ST XNKT 06 006 KRLY	✓	✓	32	4	50	150	32			
ST XNKT 08 007 KRLY	✓	✓	32	3	50	150	32	XNKT 0805	M4x10	T15

► AOMT 1236 MTSBSH

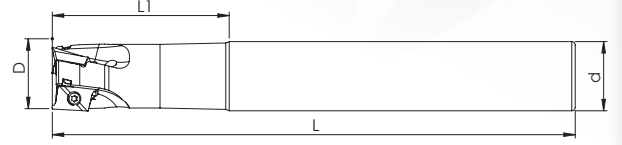



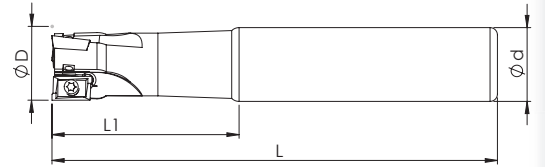

Kesici Uç Uyumluluğu Insert Suitability	Stok Stock	Inter Cooland	D	Z	L1	L	d	Uç Insert	Vida Screw	Anahtar Torx Key
MTSBSH AOMT 1236								AOMT 1236	M2.5x6	T8
ST AOMT 12 001 MTSBSH	✓	✓	16	2	40	150	16			
ST AOMT 12 002 MTSBSH	✓	✓	17	2	30	150	16			
ST AOMT 12 003 MTSBSH	✓	✓	20	3	50	150	20			
ST AOMT 12 004 MTSBSH	✓	✓	21	3	30	150	20			
ST AOMT 12 005 MTSBSH	✓	✓	25	4	30	150	24			
ST AOMT 12 006 MTSBSH	✓	✓	25	4	50	150	25			
ST AOMT 12 007 MTSBSH	✓	✓	32	4	60	150	32			
ST AOMT 12 008 MTSBSH	✓	✓	32	4	60	160	32			

► R390 11T3 SDNVK

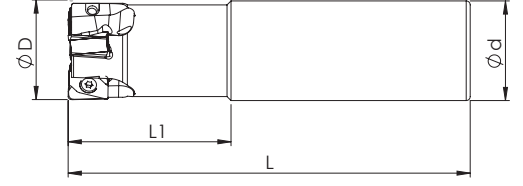



Kesici Uç Uyumluluğu Insert Suitability	Stok Stock	Inter Cooland	D	Z	L1	L	d	Uç Insert	Vida Screw	Anahtar Torx Key
SDNVK R390-11T3								R390-11T3	M2,5x6	T8
ST R390 11 001 SDNVK	✓	✓	16	2	44	150	16			
ST R390 11 002 SDNVK	✓	✓	20	3	50	150	20			
ST R390 11 003 SDNVK	✓	✓	25	3	50	150	25			
ST R390 11 004 SDNVK	✓	✓	20	3	40	100	20			

► ANHG 1005 VNDRT

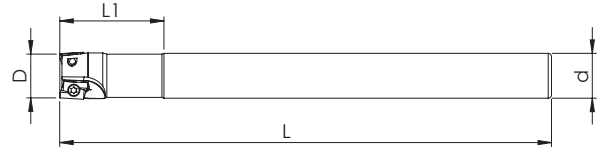
Kesici Uç Uyumluluğu Insert Suitability	Stok Stock	Inter Cooland	D	Z	L1	L	d			
VNDRT ANHG 1005								Uç Insert	Vida Screw	Anahtar Torx Key
ST ANHG 10 001 VNDRT	✓	✓	20	2	30	90	20	ANHG 1005	M3x10	T10
ST ANHG 10 002 VNDRT	✓	✓	20	2	30	120	20			
ST ANHG 10 003 VNDRT	✓	✓	20	2	50	150	20			
ST ANHG 10 004 VNDRT	✓	✓	25	3	40	100	25			
ST ANHG 10 005 VNDRT	✓	✓	25	3	40	150	25			
ST ANHG 10 006 VNDRT	✓	✓	32	3	40	110	32			

► AXMT 0602 TT

Kesici Uç Uyumluluğu Insert Suitability	Stok Stock	Inter Cooland	D	Z	L1	L	d			
TT AXMT 0602								Uç Insert	Vida Screw	Anahtar Torx Key
ST AXMT 06 001 TT	✓	✓	10	2	30	120	9	AXMT 0602	M1,8X3,5	T6
ST AXMT 06 002 TT	✓	✓	11	2	30	120	10			
ST AXMT 06 003 TT	✓	✓	12	2	30	120	11			

► 4NKT 0603 TT

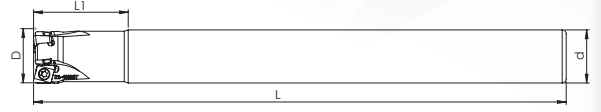

Kesici Uç Uyumluluğu Insert Suitability	Stok Stock	Inter Cooland	D	Z	L1	L	d	Uç Insert	Vida Screw	Anahtar Torx Key
TT 4NKT 0603										
ST 4NKT 06 001 TT	✓	X	16	2	45	120	16	4NKT 0603	M3X8	T10
ST 4NKT 06 002 TT	✓	X	16	2	45	150	16			
ST 4NKT 06 003 TT	✓	X	17	2	35	150	16			
ST 4NKT 06 004 TT	✓	X	17	2	35	200	16			
ST 4NKT 06 005 TT	✓	X	20	3	50	160	20			
ST 4NKT 06 006 TT	✓	X	21	3	35	200	20			
ST 4NKT 06 007 TT	✓	X	25	3	60	200	25			
ST 4NKT 06 008 TT	✓	X	26	3	30	200	25			
ST 4NKT 06 009 TT	✓	X	25	3	60	120	25			
ST 4NKT 06 010 TT	✓	X	20	3	45	120	20			
ST 4NKT 06 011 TT	✓	X	20	2	45	160	20			

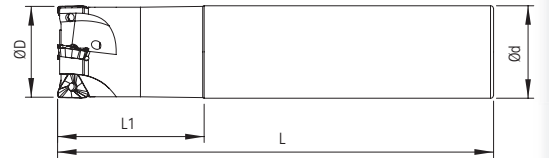

► 3PKT 1004 TT



Kesici Uç Uyumluluğu Insert Suitability	Stok Stock	Inter Cooland	D	Z	L1	L	d	Uç Insert	Vida Screw	Anahtar Torx Key
TT 3PKT 1004										
ST 3PKT 10 001 TT	✓	✓	20	2	40	150	20	3PKT 1004	M2,5x6	T8
ST 3PKT 10 002 TT	✓	✓	25	3	50	150	25			
ST 3PKT 10 003 TT	X	✓	32	4	35	150	32			

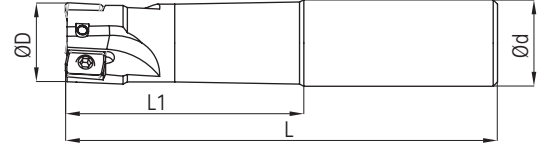

► BDMT 1103 WDA



Kesici Uç Uyumluluğu Insert Suitability		Stok Stock									
WDA BDMT 1103			Inter Cooland	D	Z	L1	L	d	Uç Insert	Vida Screw	Anahtar Torx Key
ST BDMT 11 002 WDA	✓		X	16	2	40	150	16	BDMT 1103	M2.5X6	T08
ST BDMT 11 003 WDA	✓		X	20	3	30	120	M2.5X7			
ST BDMT 11 004 WDA	✓		X	20	3	40	150	M2.5X8			
ST BDMT 11 005 WDA	✓		X	25	3	30	120	M2.5X8			

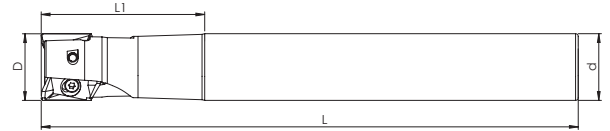

► EDPT 1404 KNNMTL

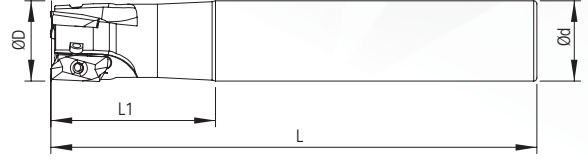

Kesici Uç Uyumluluğu Insert Suitability		Stok Stock									
KNNMTL EDPT 1404			Inter Cooland	D	Z	L1	L	d	Uç Insert	Vida Screw	Anahtar Torx Key
ST EDPT 14 001 KNNMTL	✓		✓	20	2	25	120	20	EDPT 1404	M3x9	T10
ST EDPT 14 002 KNNMTL	✓		✓	20	2	25	150	20			
ST EDPT 14 003 KNNMTL	X		✓	25	3	25	120	25			
ST EDPT 14 004 KNNMTL	✓		✓	25	3	25	150	25			

► EDPT 10T3/1805 KNNMTL



Kesici Uç Uyumluluğu Insert Suitability	Stok Stock	Inter Cooland	D	Z	L1	L	d			
								Uç Insert	Vida Screw	Anahtar Torx Key
KNNMTL EDPT 10T3/1805								EDPT 10T3	M2,5x6	T8
ST EDPT 10 001 KNNMTL	✓	X	16	2	45	150	16			
ST EDPT 10 002 KNNMTL	✓	X	18	2	30	150	16			
ST EDPT 10 003 KNNMTL	✓	X	20	3	50	150	20			
ST EDPT 10 004 KNNMTL	✓	X	25	3	50	150	25			
ST EDPT 10 005 KNNMTL	X	X	17	2	30	150	16			
ST EDPT 10 006 KNNMTL	X	X	21	3	50	150	20			
ST EDPT 10 007 KNNMTL	X	X	16	2	30	120	14			
EDPT 1805								M3,5x8	T15	
ST EDPT 18 005 KNNMTL	X	X	25	2	50	200	25			
ST EDPT 18 006 KNNMTL	X	X	32	3	50	200	32			

► BOMT 1304 INGRSL

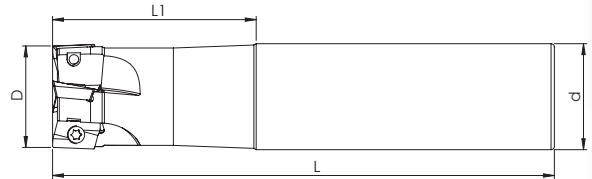

Kesici Uç Uyumluluğu Insert Suitability	Stok Stock	Inter Cooland	D	Z	L1	L	d			
								Uç Insert	Vida Screw	Anahtar Torx Key
INGRSL BOMT 1304								BOMT 1304	M3,5x8	T15
ST BOMT 13 001 INGRSL	✓	X	20	2	45	150	20			
ST BOMT 13 002 INGRSL	✓	X	22	2	35	150	20			
ST BOMT 13 003 INGRSL	✓	X	25	3	50	150	25			
ST BOMT 13 004 INGRSL	✓	X	32	4	35	150	25			
ST BOMT 13 005 INGRSL	✓	X	32	4	60	150	32			

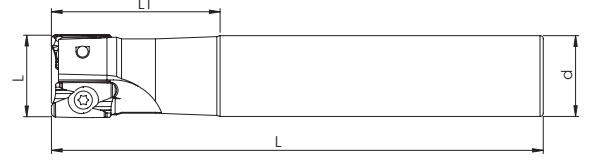
► AOMT 1605 INGRSL

Kesici Uç Uyumluluğu Insert Suitability	Stok Stock	Inter Cooland	D	Z	L1	L	d	Uç Insert	Vida Screw	Anahtar Torx Key
INGRSL AOMT 1605										
ST AOMT 16 001 INGRSL	✓	✗	25	2	40	120	25	AOMT 1605	M4X9	T15
ST AOMT 16 002 INGRSL	✓	✗	25	2	50	150	25			
ST AOMT 16 003 INGRSL	✓	✗	25	2	60	200	25			
ST AOMT 16 004 INGRSL	✓	✗	32	3	40	150	25			
ST AOMT 16 005 INGRSL	✓	✗	32	3	50	150	32			

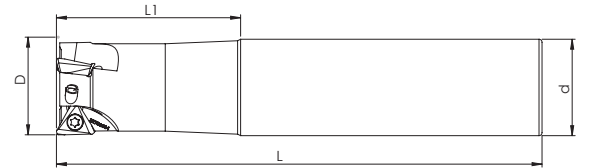
► TOMT 0603/1004 TNGLY

Kesici Uç Uyumluluğu Insert Suitability	Stok Stock	Inter Cooland	D	Z	L1	L	d	Uç Insert	Vida Screw	Anahtar Torx Key
TNGLY TOMT 0603/1004										
ST TOMT 06 001 TNGLY	✓	✓	16	2	40	150	16	TOMT 0603	M3X6	T10
ST TOMT 06 002 TNGLY	✓	✓	18	2	30	150	16			
ST TOMT 06 003 TNGLY	✓	✓	20	3	40	150	20			
ST TOMT 10 004 TNGLY	✓	✓	25	2	60	160	25	TOMT 1004	M3,5X8	T15
ST TOMT 10 005 TNGLY	✓	✓	32	3	60	160	32			

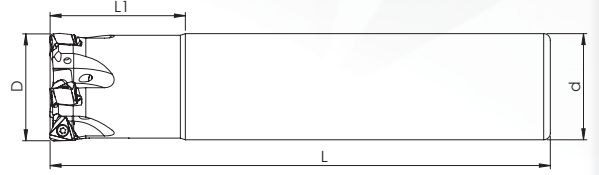

► TNGX 1004 PRMT

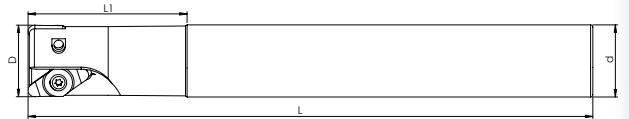

Kesici Uç Uyumluluğu Insert Suitability	Stok Stock	Inter Cooland	D	Z	L1	L	d			
PRMT TNGX 1004								Uç Insert	Vida Screw	Anahtar Torx Key
ST TNGX 10 001 PRMT	✓	✓	18	2	35	150	16	TNGX 1004	M2,5X7	T8
ST TNGX 10 002 PRMT	✓	✓	21	3	35	150	20			
ST TNGX 10 003 PRMT	✓	✓	26	4	35	150	25			
ST TNGX 10 004 PRMT	✓	✓	26	4	35	200	25			
ST TNGX 10 005 PRMT	✓	✓	33	5	40	150	32			
ST TNGX 10 006 PRMT	✓	✓	33	5	40	200	32			

► VCGT 2205/1604 ISO

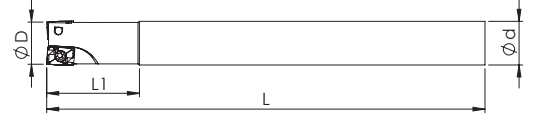

Kesici Uç Uyumluluğu Insert Suitability	Stok Stock	Inter Cooland	D	Z	L1	L	d			
ISO VCGT 220530/160408								Uç Insert	Vida Screw	Anahtar Torx Key
ST VCGT 22 001 ISO	✓	×	32	2	70	250	32	VCGT 2205	M5X12	T20
ST VCGT 22 002 ISO	✓	×	33	2	50	250	32			
ST VCGT 16 003 ISO	✓	×	32	3	80	300	32	VCGT 1604	M4X11	T15

► BDMT 0703 KYCR

Kesici Uç Uyumluluğu Insert Suitability	Stok Stock	Inter Cooland	D	Z	L1	L	d	Uç Insert	Vida Screw	Anahtar Torx Key
KYCR BDMT 0703										
ST BDMT 07 001 KYCR	✓	✓	10	1	20	100	10	BDMT 0703	M2X5	T6
ST BDMT 07 002 KYCR	✓	✓	11	2	25	120	10			
ST BDMT 07 003 KYCR	✓	✓	12	2	25	120	11			
ST BDMT 07 004 KYCR	✓	✓	12	2	30	120	12			
ST BDMT 07 005 KYCR	✓	✓	16	3	30	120	16			

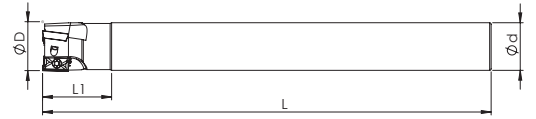
► BDMT 1704 KYCR

Kesici Uç Uyumluluğu Insert Suitability	Stok Stock	Inter Cooland	D	Z	L1	L	d	Uç Insert	Vida Screw	Anahtar Torx Key
KYCR BDMT 1704										
ST BDMT 17 001 KYCR	✓	✓	25	2	60	160	25	BDMT 1704	M4X8	T15
ST BDMT 17 002 KYCR	✓	✓	25	2	60	200	25			
ST BDMT 17 003 KYCR	✓	✓	32	3	70	200	32			
ST BDMT 17 004 KYCR	✓	✓	32	3	70	260	32			
ST BDMT 17 005 KYCR	✓	✓	33	3	45	250	32			
ST BDMT 17 006 KYCR	✓	✓	33	3	45	300	32			

► BDMT 11T3 KYCR

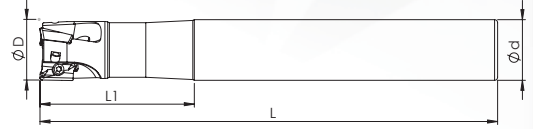



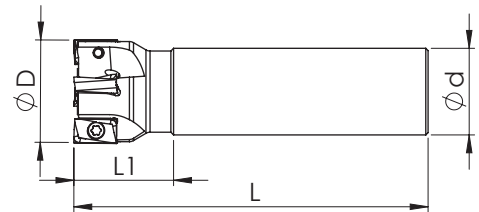

Kesici Uç Uyumluluğu Insert Suitability	Stok Stock	Inter Cooland	D	Z	L1	L	d	Uç Insert	Vida Screw	Anahtar Torx Key
KYCR BDMT 11T3										
ST BDMT 11 001 KYCR	✓	✓	16	2	50	160	16	BDMT 11T3	M2,5X6	T8
ST BDMT 11 002 KYCR	✓	✓	16	2	50	180	16			
ST BDMT 11 004 KYCR	✓	✓	17	2	25	160	16			
ST BDMT 11 005 KYCR	✓	✓	17	2	25	200	16			
ST BDMT 11 006 KYCR	✓	✓	17	2	25	260	16			
ST BDMT 11 007 KYCR	✓	✓	20	3	30	110	20			
ST BDMT 11 008 KYCR	✓	✓	20	3	50	160	20			
ST BDMT 11 009 KYCR	✓	✓	20	3	50	180	20			
ST BDMT 11 010 KYCR	✓	✓	20	3	60	200	20			
ST BDMT 11 011 KYCR	✓	✓	21	3	35	160	20			
ST BDMT 11 012 KYCR	✓	✓	21	3	35	180	20			
ST BDMT 11 013 KYCR	✓	✓	21	3	35	200	20			
ST BDMT 11 014 KYCR	✓	✓	21	3	35	260	20			
ST BDMT 11 015 KYCR	✓	✓	25	3	50	160	25			
ST BDMT 11 016 KYCR	✓	✓	25	3	60	200	25			
ST BDMT 11 017 KYCR	✓	✓	26	3	35	160	25			
ST BDMT 11 018 KYCR	✓	✓	26	3	35	200	25			
ST BDMT 11 019 KYCR	✓	✓	26	3	35	260	25			
ST BDMT 11 020 KYCR	✓	✓	32	3	40	300	30			
ST BDMT 11 021 KYCR	✓	✓	32	4	80	200	32			
ST BDMT 11 022 KYCR	✓	✓	32	4	80	260	32			
ST BDMT 11 023 KYCR	✓	✓	32	4	80	300	32			
ST BDMT 11 024 KYCR	✓	✓	33	4	40	200	32			
ST BDMT 11 025 KYCR	✓	✓	33	4	40	260	32			

► LOMU 1505 KYCR

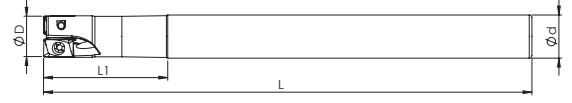



Kesici Uç Uyumluluğu Insert Suitability	Stok Stock	Inter Cooland	D	Z	L1	L	d	Uç Insert	Vida Screw	Anahtar Torx Key
KYCR LOMU 1505										
ST LOMU 15 001 KYCR	✓	✓	28	2	36	130	25	LOMU 1505	M4X8	T15
ST LOMU 15 002 KYCR	✓	✓	28	2	36	210	25			
ST LOMU 15 003 KYCR	✓	✓	30	2	36	130	25			
ST LOMU 15 004 KYCR	✓	✓	32	2	40	130	32			
ST LOMU 15 005 KYCR	✓	✓	35	3	36	130	32			
ST LOMU 15 006 KYCR	✓	✓	35	3	36	180	32			
ST LOMU 15 007 KYCR	✓	✓	39	4	36	130	32			

► LOMU 1004 KYCR

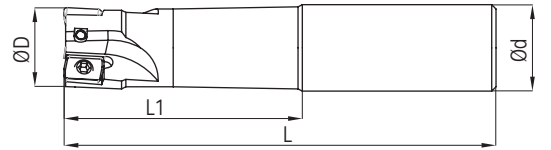



Kesici Uç Uyumluluğu Insert Suitability	Stok Stock	Inter Cooland	D	Z	L1	L	d			
KYCR LOMU 1004								Uç Insert	Vida Screw	Anahtar Torx Key
ST LOMU 10 001 KYCR	✓	✓	16	2	36	100	16	LOMU 1004	M3X8	T10
ST LOMU 10 002 KYCR	✓	✓	16	2	36	160	16			
ST LOMU 10 003 KYCR	✓	✓	17	2	36	180	16			
ST LOMU 10 004 KYCR	✓	✓	20	2	36	110	20			
ST LOMU 10 005 KYCR	✓	✓	20	2	36	150	20			
ST LOMU 10 006 KYCR	✓	✓	20	3	36	200	20			
ST LOMU 10 007 KYCR	✓	✓	21	3	36	180	20			
ST LOMU 10 008 KYCR	✓	✓	25	3	36	120	25			
ST LOMU 10 009 KYCR	✓	✓	25	3	36	180	25			
ST LOMU 10 010 KYCR	✓	✓	16	2	36	150	16			
ST LOMU 10 011 KYCR	✓	✓	25	3	36	150	25			

► APCT 1135 KLP

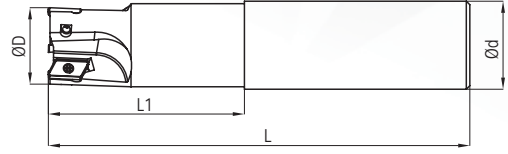
Kesici Uç Uyumluluğu Insert Suitability	Stok Stock	Inter Cooland	D	Z	L1	L	d			
KLP APCT 1135								Uç Insert	Vida Screw	Anahtar Torx Key
ST APCT 11 001 KLP	✓	X	12	1	30	120	12	APCT 1135..	M2.5X6	T08
ST APCT 11 002 KLP	✓	✓	16	2	30	150	14			
ST APCT 11 003 KLP	✓	✓	16	2	30	100	16			
ST APCT 11 004 KLP	✓	✓	16	2	30	120	16			
ST APCT 11 005 KLP	✓	X	16	2	40	150	16			
ST APCT 11 006 KLP	✓	✓	18	2	40	150	16			
ST APCT 11 007 KLP	✓	✓	20	2	30	100	20			
ST APCT 11 008 KLP	✓	✓	20	2	30	120	20			
ST APCT 11 009 KLP	✓	X	20	3	40	150	20			
ST APCT 11 010 KLP	✓	✓	20	3	40	250	20			
ST APCT 11 011 KLP	✓	✓	20	3	40	350	20			
ST APCT 11 012 KLP	✓	✓	22	3	40	150	20			
ST APCT 11 013 KLP	✓	X	25	3	30	150	24			
ST APCT 11 014 KLP	✓	✓	25	3	30	100	25			
ST APCT 11 015 KLP	✓	✓	25	3	30	120	25			
ST APCT 11 016 KLP	✓	X	25	3	40	150	25			
ST APCT 11 017 KLP	✓	X	27	3	40	150	25			
ST APCT 11 018 KLP	✓	X	32	4	30	120	32			
ST APCT 11 019 KLP	✓	X	32	4	40	150	32			
ST APCT 11 020 KLP	✓	X	35	4	40	150	32			



► APXT 1003 KLP

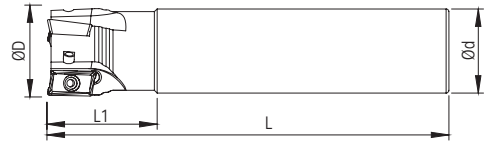

Kesici Uç Uyumluluğu Insert Suitability	Stok Stock	Inter Cooland	D	Z	L1	L	d			
								Uç Insert	Vida Screw	Anahtar Torx Key
KLP APXT 1003										
ST APXT 10 001 KLP	✓	✗	16	2	30	100	16	APXT 1003..	M2.5X6	T08
ST APXT 10 002 KLP	✓	✗	16	2	30	120	16			
ST APXT 10 003 KLP	✓	✗	16	2	40	150	16			
ST APXT 10 004 KLP	✓	✗	17	2	40	150	16			
ST APXT 10 005 KLP	✓	✗	17	2	40	200	16			
ST APXT 10 006 KLP	✓	✗	17	2	40	250	16			
ST APXT 10 007 KLP	✓	✗	18	2	40	150	16			
ST APXT 10 008 KLP	✓	✗	20	3	30	100	20			
ST APXT 10 009 KLP	✓	✗	20	3	30	120	20			
ST APXT 10 010 KLP	✓	✗	20	3	40	150	20			
ST APXT 10 011 KLP	✓	✗	21	3	40	150	20			
ST APXT 10 012 KLP	✓	✗	21	3	40	200	20			
ST APXT 10 013 KLP	✓	✗	21	3	40	250	20			
ST APXT 10 014 KLP	✓	✗	22	3	40	150	20			
ST APXT 10 015 KLP	✓	✗	25	3	30	100	25			
ST APXT 10 016 KLP	✓	✗	25	3	30	120	25			
ST APXT 10 017 KLP	✓	✗	25	3	40	150	25			
ST APXT 10 018 KLP	✓	✗	27	3	40	150	25			
ST APXT 10 019 KLP	✓	✗	25	4	40	200	25			
ST APXT 10 020 KLP	✓	✗	25	4	40	250	25			
ST APXT 10 021 KLP	✓	✗	35	4	40	150	32			
									M2.5X7	

► APKT 1604 KLP



Kesici Uç Uyumluluğu Insert Suitability	Stok Stock	Inter Cooland	D	Z	L1	L	d			
								Uç Insert	Vida Screw	Anahtar Torx Key
KLP APKT 1604										
ST AP..16 001 KLP	✓	✓	25	2	50	150	25	APKT 1604	M3,5x8	T15
ST AP..16 002 KLP	✓	✓	26	2	50	150	25			
ST AP..16 003 KLP	✓	✓	32	3	50	150	25			
ST AP..16 004 KLP	✓	✓	32	3	50	150	32			
ST AP..16 005 KLP	✓	✓	35	3	40	150	32			
ST AP..16 007 KLP	✓	✓	30	3	35	150	25			
ST AP..16 008 KLP	✓	✓	33	3	50	150	32			
ST AP..16 009 KLP	✓	✓	40	4	60	150	40			

► APKT 1003 KLP



Kesici Uç Uyumluluğu Insert Suitability	Stok Stock	Inter Cooland	D	Z	L1	L	d	Uç Insert	Vida Screw	Anahtar Torx Key
KLP APKT 1003								APKT 1003..	M2.5X6	T08
ST APKT 10 000 KLP	✓	X	13	1	40	100	12			
ST APKT 10 001 KLP	✓	X	16	2	40	150	16			
ST APKT 10 002 KLP	✓	X	18	2	40	150	16			
ST APKT 10 003 KLP	✓	X	20	3	40	150	20			
ST APKT 10 004 KLP	✓	X	22	3	40	150	20			
ST APKT 10 005 KLP	✓	X	25	3	40	150	25			
ST APKT 10 006 KLP	✓	X	27	3	40	150	25			
ST APKT 10 007 KLP	✓	X	35	4	40	150	32			
ST APKT 10 008 KLP	✓	X	17	2	40	150	16			
ST APKT 10 009 KLP	✓	X	21	3	40	150	20			
ST APKT 10 010 KLP	✓	X	26	3	40	150	25			
ST APKT 10 011 KLP	✓	X	33	4	40	150	32			
ST APKT 10 012 KLP	✓	X	33	4	40	150	32			
ST APKT 10 013 KLP	✓	X	40	5	40	150	32			
ST APKT 10 014 KLP	✓	X	40	5	40	150	40			

► APKT 1704 KLP

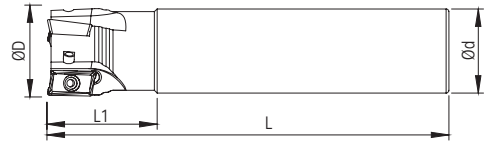

Kesici Uç Uyumluluğu Insert Suitability	Stok Stock	Inter Cooland	D	Z	L1	L	d	Uç Insert	Vida Screw	Anahtar Torx Key
KLP APKT 1704								APKT 1704	M3,5x9	T15
ST AP..17 001 KLP	✓	✓	25	2	50	100	25			
ST AP..17 002 KLP	✓	✓	25	2	50	110	25			
ST AP..17 003 KLP	✓	✓	25	2	50	150	25			
ST AP..17 004 KLP	✓	✓	32	3	50	120	32			
ST AP..17 005 KLP	✓	✓	32	3	50	150	32			
ST AP..17 006 KLP	✓	✓	35	3	50	150	32			

► LNMX 1006 KLP



Kesici Uç Uyumluluğu Insert Suitability	Stok Stock	Inter Cooland	D	Z	L1	L	d	Uç Insert	Vida Screw	Anahtar Torx Key
KLP LNMX 1006										
ST LNMX 10 001 KLP	✓	✓	18	2	25	120	16	LNMX 1006	M3x9	T10
ST LNMX 10 002 KLP	✓	✓	20	2	40	150	20			
ST LNMX 10 003 KLP	✓	✓	26	3	35	150	25			
ST LNMX 10 004 KLP	✓	✓	32	4	50	150	32			
ST LNMX 10 005 KLP	✓	✓	40	3	50	150	32			

► LNMX 1510 KLP

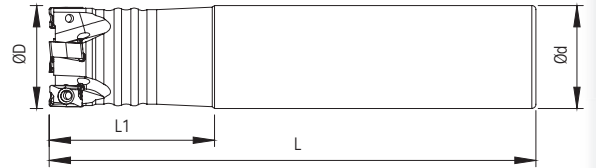

Kesici Uç Uyumluluğu Insert Suitability	Stok Stock	Inter Cooland	D	Z	L1	L	d	Uç Insert	Vida Screw	Anahtar Torx Key
KLP LNMX 1510										
ST LNMX 15 001 KLP	✓	✓	32	3	40	150	32	LNMX 1510	M4x10	T15
ST LNMX 15 002 KLP	✓	✓	32	3	40	200	25			
ST LNMX 15 002 KLP	✓	✓	32	3	40	200	32			

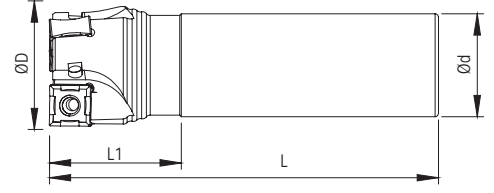
► SNMX 1206 KLP

Kesici Uç Uyumluluğu Insert Suitability	Stok Stock	Inter Cooland	D	Z	L1	L	d	Uç Insert	Vida Screw	Anahtar Torx Key
KLP SNMX 1206										
ST SNMX 12 002 KLP	✓	✓	40	3	40	150	32	SNMX 1206	M4,5x12	T20
ST SNMX 12 003 KLP	✓	✓	40	4	40	150	32			

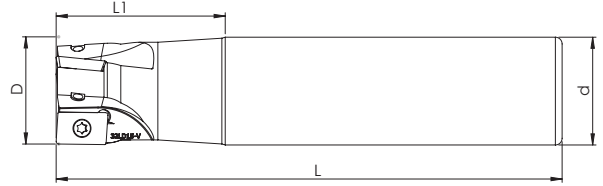
► LDEW 1503 SCO

Kesici Uç Uyumluluğu Insert Suitability	Stok Stock	Inter Cooland	D	Z	L1	L	d	Uç Insert	Vida Screw	Anahtar Torx Key
SCO LDEW 1503										
ST LDEW 15 001 SCO	✓	x	25	2	50	150	25	LDEW 1503	M3,5x8	T15
ST LDEW 15 002 SCO	✓	x	32	3	50	150	32			

► ZPMT 1003 DJT



Kesici Uç Uyumluluğu Insert Suitability	Stok Stock	Inter Cooland	D	Z	L1	L	d			
								Uç Insert	Vida Screw	Anahtar Torx Key
DJT ZPMT 1003										
ST ZPMT 10 001 DJT	✓	X	16	2	40	160	16	ZPMT 1003	M2.5X7	T08
ST ZPMT 10 002 DJT	✓	X	20	3	50	160	20			
ST ZPMT 10 003 DJT	✓	X	20	3	50	180	20			
ST ZPMT 10 004 DJT	✓	X	25	4	60	160	25			
ST ZPMT 10 005 DJT	✓	X	25	4	60	200	25			
ST ZPMT 10 006 DJT	✓	X	32	5	70	200	32			
ST ZPMT 10 007 DJT	✓	X	32	4	70	200	32			

► ADKX 1204 LMT FTTE

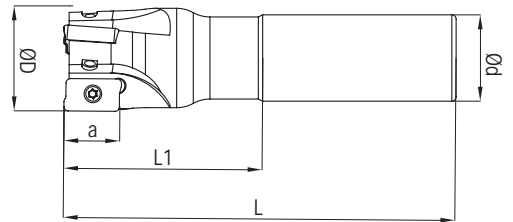

Kesici Uç Uyumluluğu Insert Suitability	Stok Stock	Inter Cooland	D	Z	L1	L	d			
								Uç Insert	Vida Screw	Anahtar Torx Key
LMT FTTE ADKX 1204										
ST ADKX 12 001 FTTE	✓	X	12	1	30	80	12	ADKX 1204	M3X6	T10
ST ADKX 12 002 FTTE	✓	X	16	2	40	140	14			
ST ADKX 12 003 FTTE	✓	X	16	2	40	140	16			
ST ADKX 12 004 FTTE	✓	X	20	2	30	171	18			
ST ADKX 12 005 FTTE	✓	X	20	2	40	90	20			
ST ADKX 12 006 FTTE	✓	X	20	2	50	171	20			
ST ADKX 12 007 FTTE	✓	X	25	2	45	100	25			
ST ADKX 12 008 FTTE	✓	X	25	2	50	171	25			
ST ADKX 12 009 FTTE	✓	X	25	3	40	171	20			
ST ADKX 12 010 FTTE	✓	X	25	3	45	100	25			
ST ADKX 12 011 FTTE	✓	X	32	3	50	111	32			
ST ADKX 12 012 FTTE	✓	X	32	3	70	201	32			
ST ADKX 12 013 FTTE	✓	X	32	4	70	201	32			

► ADMX 11T3 PRMT

Kesici Uç Uyumluluğu Insert Suitability	Stok Stock	Inter Cooland	D	Z	H	L	d	Uç Insert	Vida Screw	Anahtar Torx Key
PRMT ADMX 11T3										
ST ADMX 11 001 PRMT	✓	✗	12	1	40	120	12	ADMX 11T3..	M2,5X5	T08
ST ADMX 11 002 PRMT	✓	✗	16	2	50	150	M2,5X6			
ST ADMX 11 003 PRMT	✓	✗	20	3	50	150	M2,5X7			
ST ADMX 11 004 PRMT	✓	✗	25	3	70	200				
ST ADMX 11 005 PRMT	✓	✗	32	4	75	200				

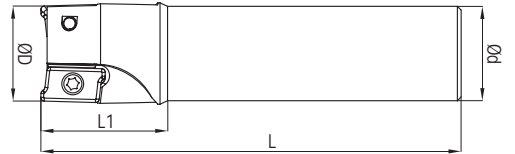
► QXMT 17 ISO

Kesici Uç Uyumluluğu Insert Suitability	Stok Stock	Inter Cooland	D	Z	L1	L	d	Uç Insert	Vida Screw	Anahtar Torx Key
ISO QXMT 17										
ST QXMT 17 001 ISO	✓	✗	25	2	70	150	25	QXMT 17	M4X8	T15
ST QXMT 17 002 ISO	✓	✗	28	2	50	150	25			
ST QXMT 17 003 ISO	✓	✗	28	2	50	160	25			
ST QXMT 17 004 ISO	✓	✗	35	3	50	150	25			

► LNGX 1205 PRMT/VNDRT

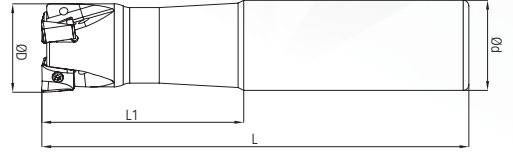

Kesici Uç Uyumluluğu Insert Suitability	Stok Stock	Inter Cooland	D	Z	H	L	d	Uç Insert	Vida Screw	Anahtar Torx Key
PRMT/VNDRT LNGX 1205										
ST LNGX 12 001 VNDRT	✓	×	25	3	50	150	25	LNGX 1205	M3,5X10	T15
ST LNGX 12 002 VNDRT	✓	×	32	3	50	150	32			



► SDMT 07/09 KLP



Kesici Uç Uyumluluğu Insert Suitability	Stok Stock	Inter Cooland	D	Z	L1	L	d	Uç Insert	Vida Screw	Anahtar Torx Key
KLP SDMT 0703/09T3										
ST SDMT 07 001 KLP	✓	✓	20	2	45	120	20	SDMT 0703	M3	T10
ST SDMT 07 002 KLP	✓	✓	20	2	25	150	20			
ST SDMT 07 003 KLP	✓	✓	21	2	25	150	20			
ST SDMT 07 004 KLP	✓	✓	25	2	50	150	25	SDMT 09T3	M3,5	T15
ST SDMT 09 005 KLP	✓	✓	26	2	35	150	25			
ST SDMT 09 006 KLP	✓	✓	32	3	37	150	25			
ST SDMT 09 007 KLP	✓	✓	32	3	70	150	32	SDMT 0703	M3	T10
ST SDMT 09 008 KLP	✓	✓	32	4	70	150	32			

► SDMT 06/09 ZCC

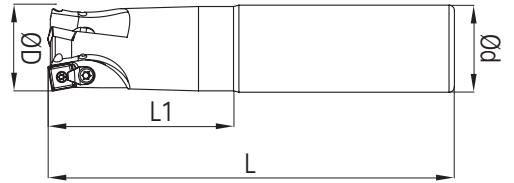

Kesici Uç Uyumluluğu Insert Suitability	Stok Stock	Inter Cooland	D	Z	L1	L	d	Uç Insert	Vida Screw	Pabuç Clamp	Vida Screw	Anahtar Torx Key
ZCC SDMT 06/09												
ST SDMT 06 001 ZCC	✓	✓	12	1	25	120	12	SDMT 06T2	M2,2x5	-	-	T15
ST SDMT 06 002 ZCC	✓	✓	16	2	40	150	16					
ST SDMT 06 003 ZCC	✓	✓	17	2	25	160	16					
ST SDMT 06 004 ZCC	✓	✓	17	2	25	170	16					
ST SDMT 06 005 ZCC	✓	✓	20	2	40	150	20					
ST SDMT 06 006 ZCC	✓	✓	20	3	40	150	20					
ST SDMT 06 007 ZCC	✓	✓	21	3	25	200	20					
ST SDMT 06 008 ZCC	✓	✓	22	3	25	150	20					
ST SDMT 06 009 ZCC	✓	✓	25	4	50	150	25					
ST SDMT 06 010 ZCC	✓	✓	25	4	50	180	25					
ST SDMT 06 011 ZCC	✓	✓	26	4	30	200	25					
ST SDMT 06 012 ZCC	✓	✓	32	5	60	200	32					
ST SDMT 09 001 ZCC	✓	✓	22	2	25	150	20	SDMT 09T3	M3,5X8	CK14	M3,5X10	
ST SDMT 09 002 ZCC	✓	✓	22	2	25	170	20					
ST SDMT 09 003 ZCC	✓	✓	25	2	60	150	25					
ST SDMT 09 005 ZCC	✓	✓	25	2	40	160	25					
ST SDMT 09 006 ZCC	✓	✓	26	2	30	200	25					
ST SDMT 09 007 ZCC	✓	✓	32	3	30	150	25					
ST SDMT 09 008 ZCC	✓	✓	32	3	50	150	32					
ST SDMT 09 009 ZCC	✓	✓	32	3	50	160	32					
ST SDMT 09 010 ZCC	✓	✓	32	3	50	170	32					
ST SDMT 09 011 ZCC	✓	✓	33	4	30	200	32					

► SP.. 08T3 PLBT

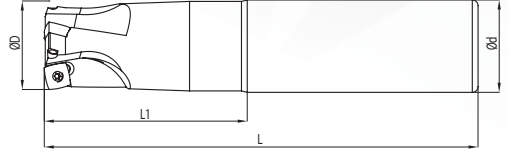

Kesici Uç Uyumluluğu Insert Suitability	Stok Stock	Inter Cooland	D	Z	L1	L	d	Uç Insert	Vida Screw	Anahtar Torx Key
PLBT SP..08T3										
ST SPKT 08 001 PLBT	X	X	20	2	60	150	20	SP..09T308	M3X10	T10
ST SPKT 08 002 PLBT	X	X	25	3	70	150	25			

► BLM. 0603 TT

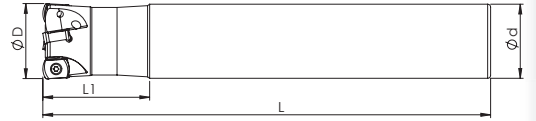

Kesici Uç Uyumluluğu Insert Suitability	Stok Stock	Inter Cooland	D	Z	L1	L	d	Uç Insert	Vida Screw	Anahtar Torx Key
TT BLM. 0603										
ST BLMP 06 001 TT	✓	✓	16	2	35	150	15	BLM.0603	M2,5X8	T8
ST BLMP 06 002 TT	✓	✓	16	2	35	150	16			
ST BLMP 06 003 TT	✓	✓	17	2	35	150	16			
ST BLMP 06 004 TT	✓	✓	17	2	35	200	16			
ST BLMP 06 005 TT	✓	✓	21	3	35	150	20			
ST BLMP 06 006 TT	✓	✓	21	3	35	200	20			
ST BLMP 06 007 TT	✓	✓	26	4	35	150	25			
ST BLMP 06 008 TT	✓	✓	26	4	35	200	25			
ST BLMP 06 009 TT	✓	✓	25	4	35	150	25			
ST BLMP 06 010 TT	✓	✓	20	3	35	150	20			
ST BLMP 06 011 TT	✓	✓	32	5	35	200	32			

► LOGU 0303 KYCR

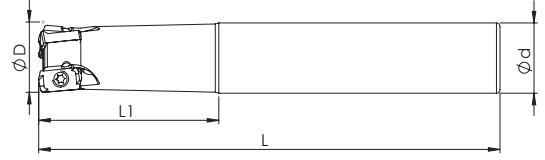

Kesici Uç Uyumluluğu Insert Suitability	Stok Stock	Inter Cooland	D	Z	L1	L	d	Uç Insert	Vida Screw	Anahtar Torx Key
KYCR LOGU 030310										
ST LOGU 03 001 KYCR	✓	✓	16	2	30	100	16	LOGU 0303	M3x8	T10
ST LOGU 03 002 KYCR	✓	✓	16	2	60	160	16			
ST LOGU 03 003 KYCR	✓	✓	16	2	60	200	16			
ST LOGU 03 004 KYCR	✓	✓	17	2	25	160	16			
ST LOGU 03 005 KYCR	✓	✓	17	2	25	200	16			
ST LOGU 03 006 KYCR	✓	✓	18	2	25	160	16			
ST LOGU 03 007 KYCR	✓	✓	20	3	50	130	20			
ST LOGU 03 008 KYCR	✓	✓	20	3	60	160	20			
ST LOGU 03 009 KYCR	✓	✓	20	3	60	220	20			
ST LOGU 03 010 KYCR	✓	✓	21	3	25	160	20			
ST LOGU 03 011 KYCR	✓	✓	22	3	25	160	20			
ST LOGU 03 012 KYCR	✓	✓	22	3	25	180	20			
ST LOGU 03 013 KYCR	✓	✓	25	4	50	160	25			
ST LOGU 03 014 KYCR	✓	✓	25	4	50	180	25			
ST LOGU 03 015 KYCR	✓	✓	26	4	30	180	25			
ST LOGU 03 016 KYCR	✓	✓	26	4	30	160	25			
ST LOGU 03 017 KYCR	✓	✓	26	2	30	300	25			
ST LOGU 03 018 KYCR	✓	✓	28	5	30	160	25			
ST LOGU 03 019 KYCR	✓	✓	28	5	30	180	25			
ST LOGU 03 020 KYCR	✓	✓	32	5	60	160	32			
ST LOGU 03 021 KYCR	✓	✓	32	5	60	200	32			
ST LOGU 03 022 KYCR	✓	✓	33	5	35	160	32			
ST LOGU 03 023 KYCR	✓	✓	25	4	50	150	25			

► LPGT 0102 KYCR

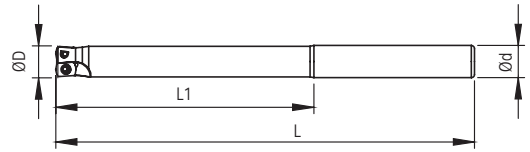

Kesici Uç Uyumluluğu Insert Suitability	Stok Stock	Inter Cooland	D	Z	L1	L	d	Uç Insert	Vida Screw	Anahtar Torx Key
KYCR LPGT 010210										
ST LPGT 0102 001 KYCR	✓	✓	9	1	15	75	10	LPGT 0102	M2x5	T6
ST LPGT 0102 002 KYCR	✓	✓	10	2	20	100	10			
ST LPGT 0102 003 KYCR	✓	✓	11	2	22	120	10			
ST LPGT 0102 004 KYCR	✓	✓	12	2	20	120	11			
ST LPGT 0102 005 KYCR	✓	✓	12	3	20	120	11			
ST LPGT 0102 006 KYCR	✓	✓	12	2	25	120	12			
ST LPGT 0102 007 KYCR	✓	✓	12	3	80	150	12			
ST LPGT 0102 008 KYCR	✓	✓	14	3	40	100	14			
ST LPGT 0102 009 KYCR	✓	✓	14	3	40	160	16			
ST LPGT 0102 010 KYCR	✓	✓	16	4	30	160	16			
ST LPGT 0102 011 KYCR	✓	✓	12	2	25	100	12			
ST LPGT 0102 012 KYCR	✓	✓	12	3	25	120	12			

► SDKX 0904 LMN

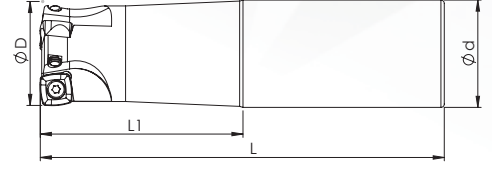

Kesici Uç Uyumluluğu Insert Suitability	Stok Stock	Inter Cooland	D	Z	L1	L	d	Uç Insert	Vida Screw	Anahtar Torx Key
LMN SDKX 0904										
ST SDKX 09 001 LMN	✓	✓	25	2	60	120	25	SDKX 0904	M3,5x10	T15
ST SDKX 09 002 LMN	✓	✓	25	2	60	200	25			
ST SDKX 09 003 LMN	✓	✓	32	3	60	120	32			
ST SDKX 09 004 LMN	✓	✓	32	3	60	150	32			
ST SDKX 09 005 LMN	✓	✓	32	3	60	200	32			

► SOMT 12T3 MTSBHS

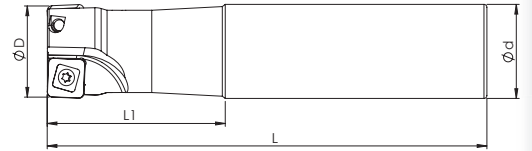

Kesici Uç Uyumluluğu Insert Suitability	Stok Stock	Inter Cooland	D	Z	L1	L	d	Uç Insert	Vida Screw	Anahtar Torx Key
MTSBHS SOMT 12T308										
ST SOMT 12 001 MTSBHS	✓	✓	32	2	60	150	32	SOMT 12T3	M5x9	T20
ST SOMT 12 002 MTSBHS	✓	✓	40	3	45	150	32			

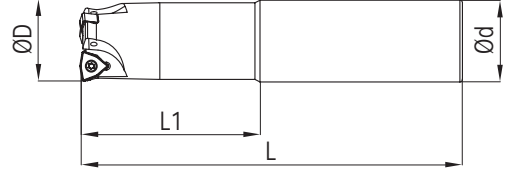
► WNMX 09T3 KRLY

Kesici Uç Uyumluluğu Insert Suitability	Stok Stock	Inter Cooland	D	Z	L1	L	d	Uç Insert	Vida Screw	Anahtar Torx Key
KRLY WNMX 09T316										
ST WNMX 09 003 KRLY	✓	✓	25	2	70	150	25	WNMX 09T3	M3X8	T10
ST WNMX 09 004 KRLY	✓	✓	32	3	70	150	32			

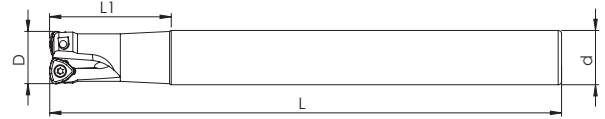
► WNMX 0603 KRLY

Kesici Uç Uyumluluğu Insert Suitability	Stok Stock	Inter Cooland	D	Z	L1	L	d	Uç Insert	Vida Screw	Anahtar Torx Key
KRLY WNMX 060312										
ST WNMX 06 001 KRLY	✓	✓	16	2	70	150	16	WNMX 0603	M2,5X8	T8
ST WNMX 06 002 KRLY	✓	✓	20	3	70	150	20			

► LPMW 0402 KRLY

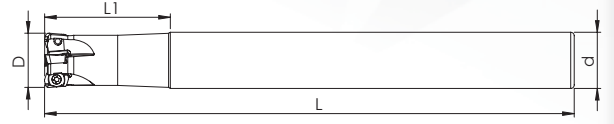

Kesici Uç Uyumluluğu Insert Suitability	Stok Stock	Inter Cooland	D	Z	L1	L	d	Uç Insert	Vida Screw	Anahtar Torx Key
KRLY LPMW 040210										
ST LPMW 04 001 KRLY	✓	✗	10	2	35	120	10	LPMW 0402	M1,8	T6
ST LPMW 04 002 KRLY	✗	✗	12	3	35	120	12			
ST LPMW 04 003 KRLY	✗	✗	16	4	35	150	16			

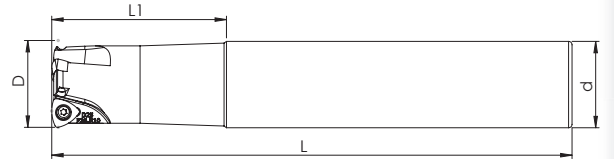

► P26335 R10/R14 WLTR

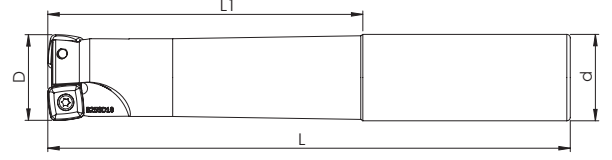

Kesici Uç Uyumluluğu Insert Suitability	Stok Stock	Inter Cooland	D	Z	L1	L	d	Uç Insert	Vida Screw	Anahtar Torx Key
WLTR P26335 -R10-R14										
ST P2633 R 10 001 WLTR	✓	✓	21	2	26	120	20	P26335 R10	M2,5X8	T8
ST P2633 R 10 002 WLTR	✓	✓	25	3	50	150	25			
ST P2633 R 10 003 WLTR	✓	✓	26	3	30	200	25			
ST P2633 R 10 004 WLTR	✓	✓	32	4	60	150	32	P26335 R14	M4X10	T15
ST P2633 R 14 001 WLTR	✓	✓	32	3	60	150	32			

► SDMT 1004 BHLR



Kesici Uç Uyumluluğu Insert Suitability	Stok Stock	Inter Cooland	D	Z	L1	L	d			
BHLR SDMT 1004								Uç Insert	Vida Screw	Anahtar Torx Key
ST SDMT 10 001 BHLR	✓	✓	17	1	30	150	16	SDMT 1004	M3X8	T10
ST SDMT 10 002 BHLR	✓	✓	25	2	90	150	25			
ST SDMT 10 003 BHLR	✓	✓	32	3	90	150	32			

► BNGX 10T3 PRMT

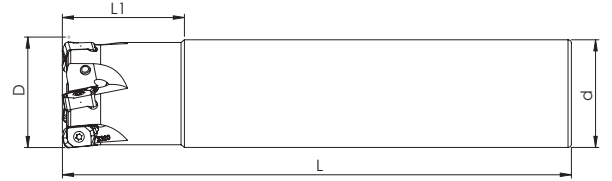

Kesici Uç Uyumluluğu Insert Suitability	Stok Stock	Inter Cooland	D	Z	L1	L	d			
PRMT BNGX 10T3								Uç Insert	Vida Screw	Anahtar Torx Key
ST BNGX 10 001 PRMT	✓	✓	17	2	35	150	16	BNGX 10T3	M2,5X8	T8
ST BNGX 10 002 PRMT	✓	✓	21	3	35	150	20			
ST BNGX 10 003 PRMT	✓	✓	26	4	35	150	25			
ST BNGX 10 004 PRMT	✓	✓	26	4	35	200	25			
ST BNGX 10 005 PRMT	✓	✓	33	5	35	150	32			
ST BNGX 10 006 PRMT	✓	✓	33	5	35	200	32			

► LNMU 0303 TNGLY

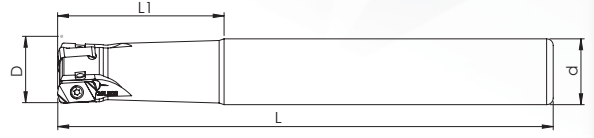

Kesici Uç Uyumluluğu Insert Suitability	Stok Stock	Inter Cooland	D	Z	L1	L	d	Uç Insert	Vida Screw	Anahtar Torx Key
TNGLY LNMU 0303										
ST LNMU 03 001 TNGLY	✓	✓	16	2	40	160	16	LNMU 0303	M2,5X8	T8
ST LNMU 03 002 TNGLY	✓	✓	18	2	35	150	16			
ST LNMU 03 003 TNGLY	✓	✓	20	3	60	160	20			
ST LNMU 03 004 TNGLY	✓	✓	21	3	35	160	20			
ST LNMU 03 005 TNGLY	✓	✓	22	3	35	150	20			
ST LNMU 03 006 TNGLY	✓	✓	25	4	50	160	25			
ST LNMU 03 007 TNGLY	✓	✓	32	4	60	160	32			

► WDKT 08 ISO

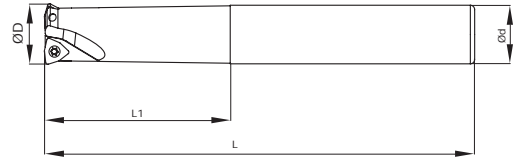

Kesici Uç Uyumluluğu Insert Suitability	Stok Stock	Inter Cooland	D	Z	L1	L	d	Uç Insert	Vida Screw	Anahtar Torx Key
ISO WDKT 08										
ST WDKT 08 001 ISO	✓	×	20	2	70	150	20	WDKT 08..	M3X8	T10
ST WDKT 08 002 ISO	✓	×	25	2	70	150	25			
ST WDKT 08 003 ISO	✓	×	30	2	70	150	32			
ST WDKT 08 004 ISO	✓	×	32	3	70	150	32			

► ZDCW 09T3 PRMT

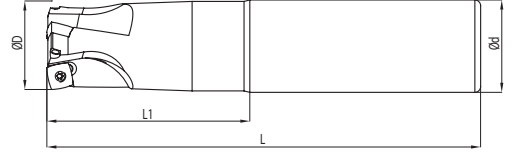

Kesici Uç Uyumluluğu Insert Suitability	Stok Stock	Inter Cooland	D	Z	L1	L	d	Uç Insert	Vida Screw	Anahtar Torx Key
PRMT ZDCW 09T3										
ST ZDCW 09 001 PRMT	✓	✓	20	2	60	150	20	ZDCW 09T3	M3X8	T15
ST ZDCW 09 002 PRMT	✓	✓	25	2	70	150	25			
ST ZDCW 09 003 PRMT	✓	✓	32	3	70	150	32			

► WOEJ 0804 WDA

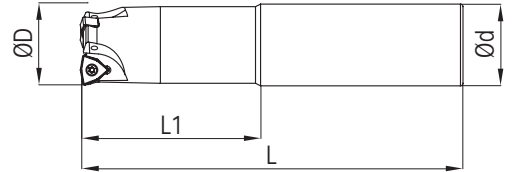

Kesici Uç Uyumluluğu Insert Suitability	Stok Stock	Inter Cooland	D	Z	L1	L	d	Uç Insert	Vida Screw	Anahtar Torx Key
WDA WOEJ 0804										
ST WOEJ 08 001 WDA	X	✓	25	2	60	150	25	WOEJ 0804	M3X8	T10
ST WOEJ 08 002 WDA	X	✓	25	2	80	200	25			
ST WOEJ 08 003 WDA	X	✓	32	3	60	150	32			
ST WOEJ 08 004 WDA	X	✓	32	3	80	200	32			

► RCKT 1204 ISO

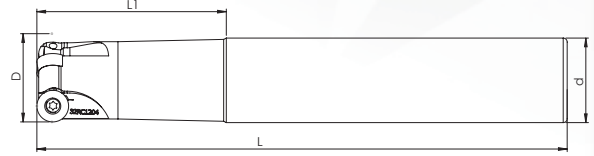



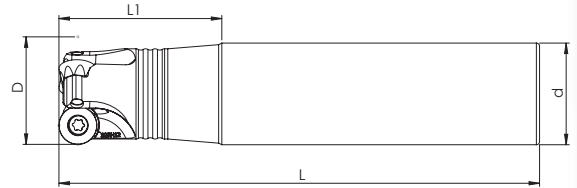

Kesici Uç Uyumluluğu Insert Suitability	Stok Stock	Inter Cooland	D	Z	L1	L	d	Uç Insert	Vida Screw	Anahtar Torx Key
ISO RCKT 1204/2006										
ST RC.. 12 001 ISO	✓	✓	25	2	60	200	25	RCKT 1204	M3,5X8	T15
ST RC.. 12 002 ISO	✓	✓	26	2	35	200	25			
ST RC.. 12 003 ISO	✓	✓	26	2	35	250	25			
ST RC.. 12 004 ISO	✓	✓	32	3	70	200	32			
ST RC.. 12 005 ISO	✓	✓	33	3	35	250	32			
ST RC.. 20 006 ISO	✓	✓	50	3	50	120	32	RCKT 2006	M6X15	T25

► RHKX 10/12 KLP

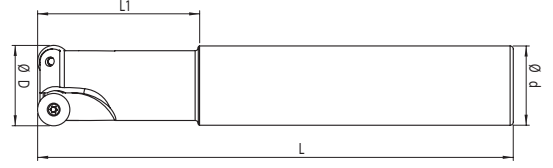

Kesici Uç Uyumluluğu Insert Suitability	Stok Stock	Inter Cooland	D	Z	L1	L	d	Uç Insert	Vida Screw	Anahtar Torx Key
KLP RHKX 10/12										
ST RHKX 10 001 KLP	✓	X	20	2	50	150	20	RHKX 10	M3,5X8	T15
ST RHKX 10 002 KLP	✓	X	25	2	50	150	25			
ST RHKX 10 003 KLP	✓	X	32	4	50	150	32			
ST RHKX 12 003 KLP	✓	X	25	2	50	150	25	RHKX 12	M4X10	
ST RHKX 12 004 KLP	✓	X	32	3	50	150	32			



Kesici Uç Uyumluluğu Insert Suitability	Stok Stock	Inter Cooland	D	Z	L1	L	d			
								Uç Insert	Vida Screw	Anahtar Torx Key
ST RD..05 001 ISO	✓	X	10	2	40	100	10	RD..0501	M2X5	T6
ST RD..05 002 ISO	✓	X	10	2	40	100	12			
ST RD..05 003 ISO	✓	X	12	2	40	100	12	RD..07T1	M2,5X6	T8
ST RD..07 004 ISO	✓	✓	12	2	20	100	12			
ST RD..07 005 ISO	✓	✓	12	2	80	140	16	RD..0702	M2,5X6	T8
ST RD..07 006 ISO	✓	✓	15	2	60	110	16	RD..0803	M3X6	T10
ST RD..08 007 ISO	✓	X	16	2	40	120	16	RD..1003	M3,5X8	T15
ST RD..08 008 ISO	✓	X	16	2	40	150	16			
ST RD..10 012 ISO	✓	X	20	2	40	120	20			
ST RD..10 013 ISO	✓	✓	20	2	50	150	20			
ST RD..10 014 ISO	✓	X	20	2	50	200	20			
ST RD..10 015 ISO	✓	X	25	2	50	150	25			
ST RD..10 016 ISO	✓	X	25	2	60	200	25			
ST RD..10 017 ISO	✓	X	32	3	60	150	32			
ST RD..10 018 ISO	✓	X	32	2	100	250	32			
ST RD..10 019 ISO	✓	X	32	3	100	250	32			
ST RD..10 020 ISO	✓	X	40	4	55	150	32			
ST RD..10 021 ISO	✓	X	40	2	55	250	32			
ST RD..10 022 ISO	✓	X	40	4	55	250	32			
ST RD..10 023 ISO	✓	X	20	2	50	150	20			
ST RD..10 024 ISO	✓	X	25	2	50	150	25			
ST RD..10 025 ISO	✓	X	25	2	70	200	25			
ST RD..10 027 ISO	✓	X	32	3	70	150	32			
ST RD..10 028 ISO	✓	X	32	2	100	250	32			
ST RD..10 029 ISO	✓	X	40	4	55	150	32			
ST RD..10 030 ISO	✓	X	40	2	55	250	32			
ST RD..10 031 ISO	✓	X	40	4	55	250	32			
ST RD..12 032 ISO	✓	X	25	2	50	150	25			
ST RD..12 033 ISO	✓	X	32	3	30	150	25			
ST RD..12 034 ISO	✓	X	32	3	60	150	32			
ST RD..10 035 ISO	✓	X	40	4	55	150	25			
ST RD..10 036 ISO	✓	X	40	4	55	150	32			
								RD..10T3		
								RD..1204		
								RD..1003		

► B.ST

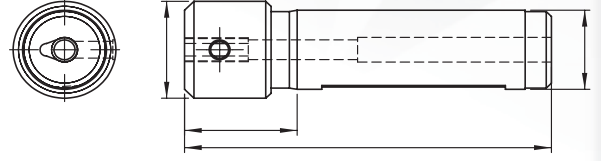

Kesici Uç Uyumluluğu Insert Suitability	Stok Stock	Inter Cooland	D	L1	L	d	Uç Insert	Vida Screw	Anahtar Torx Key
HRN B.ST									
A05.0016.07.B.ST HRN	✓	✓	20	20	70	16	A05.0016.07.B.ST	M4X8	T15
A08.0020.09.B.ST HRN	✓	✓	25	20	70	A08.0020.09.B.ST			
A09.0025.07.B.ST HRN	✓	✓	30	20	90	A09.0025.07.B.ST			

► HD 12

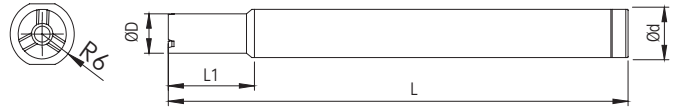



Kesici Uç Uyumluluğu Insert Suitability	Stok Stock	Inter Cooland	D	L1	L	d	Uç Insert	Vida Screw	Anahtar Torx Key
ISO									
HD 12 06 R 001 HRN	✓	✓	6	18	100	12	HD-1206 R	M3x10	T10
HD 12 07 R 002 HRN	✓	✓	7	18	100	12	HD-1207 R		
HD 12 08 R 003 HRN	✓	✓	8	18	100	12	HD-1208 R	M3,5x11	T15
HD 12 09 R 004 HRN	✓	✓	9	18	100	12	HD-1209 R		
HD 12 11 R 005 HRN	✓	✓	11	18	100	12	HD-1211 R	M4,5x12	T20



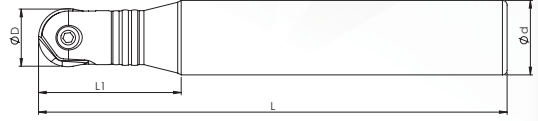



► KÜRE KFB KLP 10/12/16/20/25

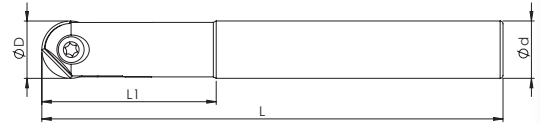

Kesici Uç Uyumluluğu Insert Suitability	Stok Stock	Inter Cooland	D	d	L1	L			
							Uç Insert	Vida Screw	Anahtar Torx Key
KLP KÜRE KFB 10/12/16/20/25									
ST KFB 001 LKP	✓	X	10	12	45	130	KFB 100	M4X9 D10	T15
ST KFB 002 KLP	✓	X	12	16	45	130	KFB 120	M5X10 D12	T20
ST KFB 003 KLP	✓	X	16	20	45	130	KFB 160	M5X12 D16	
ST KFB 004 KLP	✓	X	20	25	60	150	KFB 200	M5X16 D20	
ST KFB 005 KLP	✓	X	25	32	60	200	KFB 250	M6X22 D25	
ST KFB 006 KLP	✓	X	25	32	60	250	KFB 250	M6X22 D25	

► KÜRE 08/10/12/16/20/25/30/32 WLTR

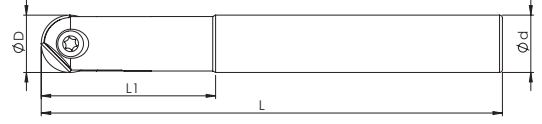

Kesici Uç Uyumluluğu Insert Suitability	Stok Stock	Inter Cooland	D	d	L1	L			
							Uç Insert	Vida Screw	Anahtar Torx Key
WLTR P3201									
ST BBMR P3208 001 WLTR	✓	X	8	10	25	110	P3208-D08	M3x0.35x7	T08
ST BBMR P3210 002 WLTR	✓	X	10	12	30	130	P3210-D10	M4x0.5x9	T15
ST BBMR P3212 003 WLTR	✓	X	12	12	32	130	P3212-D12	M5x0.5x10	T20
ST BBMR P3216 004 WLTR	✓	X	16	16	36	140	P3216-D16	M5x0.5x12	
ST BBMR P3220 005 WLTR	✓	X	20	20	45	160	P3220-D20	M5x0.5x17	
ST BBMR P3225 006 WLTR	✓	X	25	25	45	160	P3225-D25	M6x0.75x20	
ST BBMR P3230 007 WLTR	✓	X	30	32	60	175	P3230-D30	M8x1x23	T30
ST BBMR P3232 008 WLTR	✓	X	32	32	60	175	P3232-D32	M8x1x25	

► ROHX 12/16/20 ZCC

Kesici Uç Uyumluluğu Insert Suitability	Stok Stock	D	d	L1	L	Uç Insert	Vida Screw	Anahtar Torx Key
ZCC ROHX 12/16/20								
ST ROHX 12 001 ZCC	✓	12	16	45	130	R0HX 1203	M4X0,5X9	T15
ST ROHX 16 002 ZCC	✓	16	16	45	160	R0HX 1604	M5X0,5X10	T20
ST ROHX 16 003 ZCC	✓	16	16	60	200			
ST ROHX 16 004 ZCC	✓	16	16	60	250			
ST ROHX 20 005 ZCC	✓	20	20	45	160	R0HX 2005	M5X0,5X13	
ST ROHX 20 006 ZCC	✓	20	20	60	200			
ST ROHX 20 007 ZCC	✓	20	20	60	250			
ST ROHX 20 008 ZCC	✓	20	25	60	240			

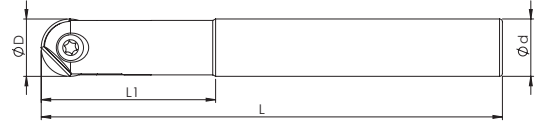

► ZOHX 12/16/20/25/32 ZCC

Kesici Uç Uyumluluğu Insert Suitability	Stok Stock	D	d	L1	L	Uç Insert	Vida Screw	Anahtar Torx Key
ZCC ZOHX 12/16/20/25/32								
ST ZOHX 12 001 ZCC	✓	12	16	45	150	Z0HX 1203	M5X10 D12	T20
ST ZOHX 16 002 ZCC	✓	16	16	60	180	Z0HX 1604	M5X12 D16	
ST ZOHX 20 003 ZCC	✓	20	20	60	200	Z0HX 2005	M5X16 D20	
ST ZOHX 25 004 ZCC	✓	25	25	60	250	Z0HX 2506	M6X22 D25	
ST ZOHX 32 005 ZCC	✓	32	32	60	250	Z0HX 3207	M8X25 D30	



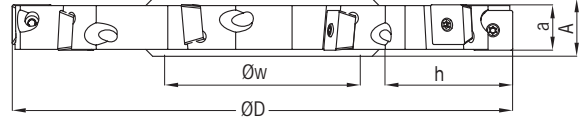



► CCMT 06/09/12 ISO

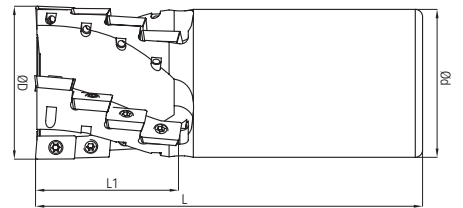

Kesici Uç Uyumluluğu Insert Suitability	Stok Stock	Inter Cooland	D	a	A	Z	h	w	  		
									Uç Insert	Vida Screw	Anahtar Torx Key
ISO CCMT 06/09/12									CC.. 0602..	M2.5X6	T08
DKF 001 ISO	✓	×	80	8	12	10	16	27	CC.. 0602..	M2.5X6	T08
DKF 002 ISO	✓	×	100	8	12	12	24	32			
DKF 003 ISO	✓	×	125	8	12	14	34	40			
DKF 004 ISO	✓	×	160	8	12	16	50	40			
DKF 005 ISO	✓	×	80	10	14	10	16	27			
DKF 006 ISO	✓	×	100	10	14	12	24	32			
DKF 007 ISO	✓	×	125	10	14	14	34	40			
DKF 008 ISO	✓	×	160	10	14	16	50	40			
DKF 009 ISO	✓	×	80	12	16	8	16	27			
DKF 010 ISO	✓	×	100	12	16	10	24	32	CC..09T3..	M3.5X9	T15
DKF 011 ISO	✓	×	125	12	16	12	34	40			
DKF 012 ISO	✓	×	160	12	16	14	50	40			
DKF 013 ISO	✓	×	80	14	18	8	16	27			
DKF 014 ISO	✓	×	100	14	18	10	24	32			
DKF 015 ISO	✓	×	125	14	18	12	34	40			
DKF 016 ISO	✓	×	160	14	18	14	50	40			
DKF 017 ISO	✓	×	80	16	20	8	16	27			
DKF 018 ISO	✓	×	100	16	20	8	24	32			
DKF 019 ISO	✓	×	125	16	20	10	34	40	CC..1204..	M5X10	T20
DKF 020 ISO	✓	×	160	16	20	12	50	40			

► S-SİSTEM HELİSEL FREZELER - S-SYSTEM HELIX END MILLS



Kesici Uç Uyumluluğu Insert Suitability	Stok Stock	Inter Cooland	D	Z	L	L1	d	  		
								Uç Insert	Vida Screw	Anahtar Torx Key
ISO APKT 1003								AP.. 1003	M2,5X7	T08
S HF AP.. 10 001 ISO	✓	×	20	6	110	27	20	AP.. 1003	M2,5X7	T08
S HF AP.. 10 002 ISO	✓	×	25	8	120	36	25			
S HF AP.. 10 003 ISO	✓	×	32	15	120	45	32			
S HF AP.. 10 004 ISO	✓	×	40	18	130	54	32			

► AP.. 1604 ISO HELİSEL FREZE

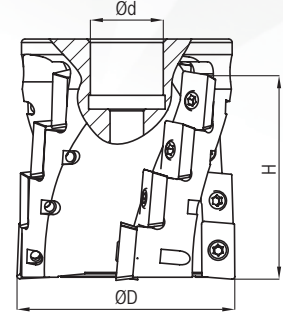

Kesici Uç Uyumluluğu Insert Suitability	Stok Stock	Inter Coolant	D	Z	H	d	Uç Insert	Vida Screw	Anahtar Torx Key
ISO AP.. 1604									
TK HF AP.. 16 001 ISO	✓	X	50	12	42	22	AP..1604..	M3.5X8	T15
TK HF AP.. 16 002 ISO	✓	X	63	16	56	22			
TK HF AP.. 16 003 ISO	✓	X	80	25	70	27			

► TCMT 11/16 ISO HAVŞA MATKABI

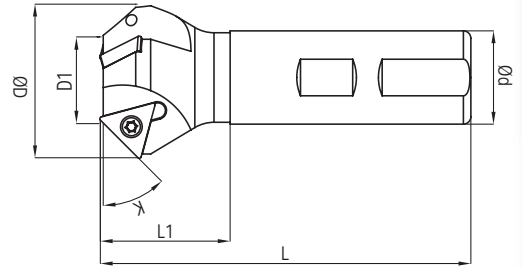

Kesici Uç Uyumluluğu Insert Suitability	Stok Stock	K	D	D1	d	L	L1	Uç Insert	Vida Screw	Anahtar Torx Key
ISO TCMT 11/16										
HM 001 ISO	✓	45°	15	4	16	L100	35	TC..11	M2,5X7	T8
HM 002 ISO	✓	45°	25	14	25	L100	35			
HM 003 ISO	✓	45°	30	16	12	L100	35			
HM 004 ISO	✓	45°	35	21	12	L100	35			
HM 005 ISO	✓	45°	23	5	16	L100	35			
HM 006 ISO	✓	45°	31	10	16	L100	35			
HM 007 ISO	✓	45°	35	14	20	L100	35	TC..16	M3,5X8	T15
HM 008 ISO	✓	45°	70	25	25	L100	35			
HM 009 ISO	✓	45°	43	22	25	L100	35			
HM 010 ISO	✓	45°	50	30	25	L100	35	TC..22	M5X12	T20
HM 011 ISO	✓	45°	64	35	32	L100	35			
HM 012 ISO	✓	60°	20	6	16	L100	35	TC..16	M3,5X8	T15
HM 013 ISO	✓	60°	35	20	16	L100	35			
HM 014 ISO	✓	60°	40	24	25	L100	35			

► CCMT 06/09 ISO

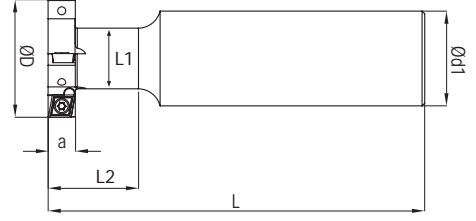

Kesici Uç Uyumluluğu Insert Suitability	Stok Stock	D	Z	a	L	L1	L2	d1	Uç Insert	Vida Screw	Anahtar Torx Key
ISO CCMT 06/09											
TF 001 ISO	✓	17	2	8	85	8	20	16	CC..0602	M2,5x7	T08
TF 002 ISO	✓	20	2	9	85	10	20	16			
TF 003 ISO	✓	21	2	9	85	10	20	16			
TF 004 ISO	✓	24	2	10	100	12	25	20			
TF 005 ISO	✓	25	2	11	100	12	25	25			
TF 006 ISO	✓	25	4	12	100	12	25	25			
TF 007 ISO	✓	32	4	8	100	16	25	25			
TF 008 ISO	✓	32	4	10	100	16	30	25			
TF 009 ISO	✓	63	8	8	125	31	40	32			
TF 010 ISO	✓	30	2	12	100	16	30	25			
TF 011 ISO	✓	32	2	14	100	16	30	25	CC..09T3	M3,5x8	T15
TF 012 ISO	✓	40	4	16	120	18	30	32			
TF 013 ISO	✓	40	4	18	120	18	30	32			
TF 014 ISO	✓	32	2	12	100	16	30	25			
TF 015 ISO	✓	40	4	12	120	18	30	32			
TF 016 ISO	✓	50	4	12	120	18	30	32			
TF 017 ISO	✓	50	4	16	120	18	30	32			

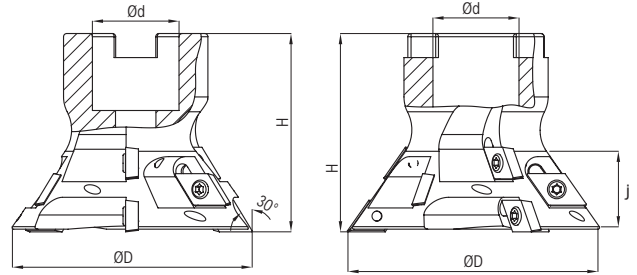
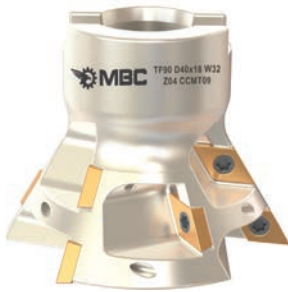

► DCMT 11 55° ISO



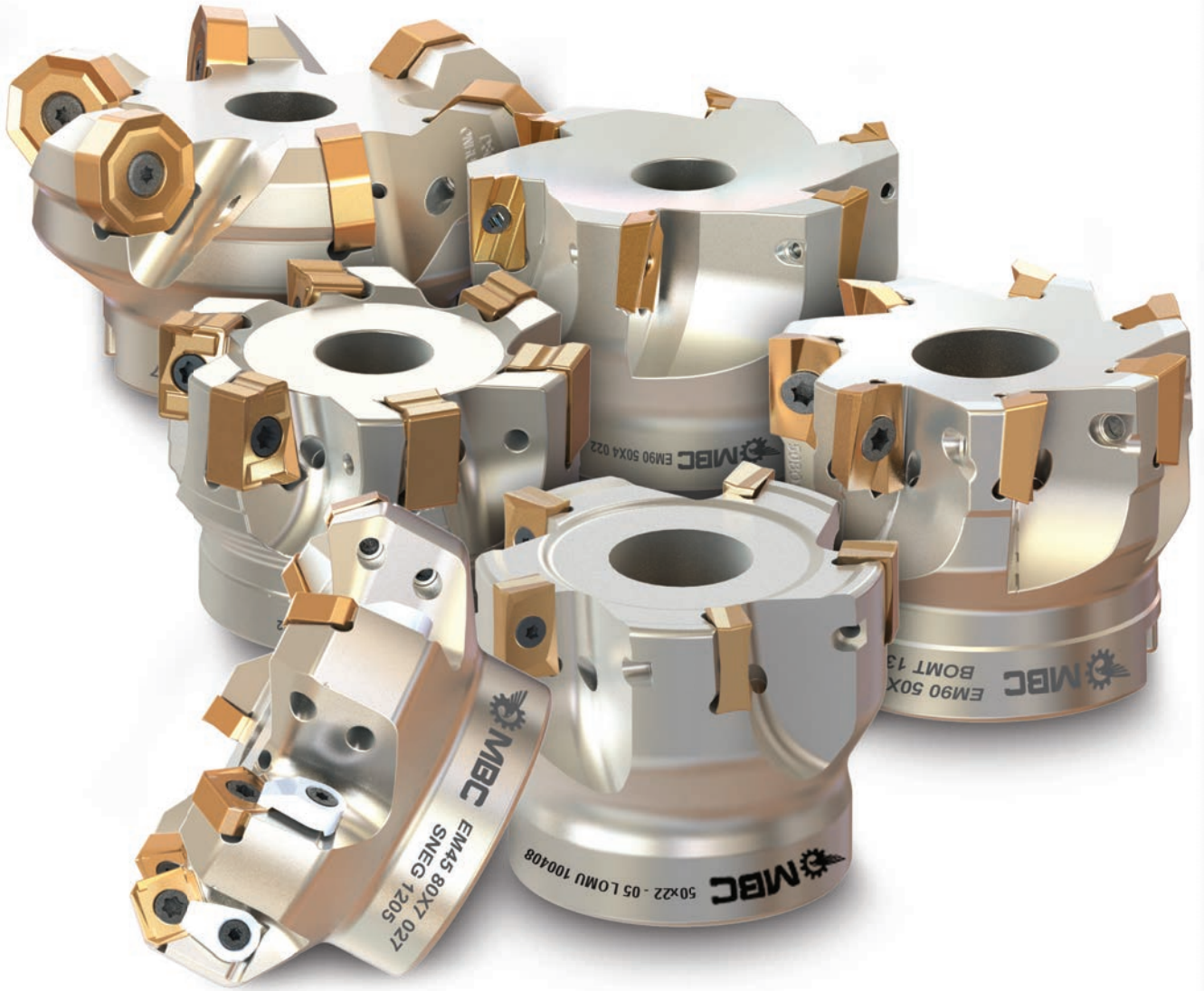

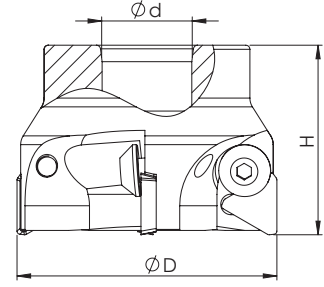

Kesici Uç Uyumluluğu Insert Suitability	Stok Stock	Inter Cooland	D	Z	H	d	j	K	Uç Insert	Vida Screw	Anahtar Torx Key
ISO											
TK KRF 55 001 ISO	✓	X	80	9	61	27	24	55°	DCMT 11T3	M3,5X11	T15
TK KRF 60 002 ISO	✓	X	80	9	61	27	26	60°			
TK KRF 60 003 ISO	✓	X	50	4	45	27	26	60°			

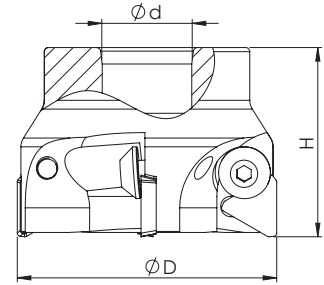
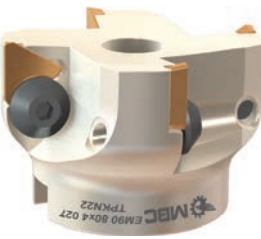

► 90° TPKN 16 ISO





Kesici Uç Uyumluluğu Insert Suitability		Stok Stock								
ISO TPKN 1603			Inter Cooland	D	Z	H	d	Uç Insert	Vida Screw	Anahtar Allen Key
TK TPKN 16 001 ISO	✓		X	50	3	41	22	TPKN 16	M6X0,75	A4
TK TPKN 16 002 ISO	✓		X	63	4	48	22			
TK TPKN 16 003 ISO	✓		X	80	5	52	32			
TK TPKN 16 004 ISO	✓		X	100	6	52	32			

► 90° TPKN 22 ISO

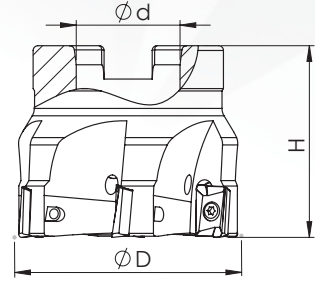
Kesici Uç Uyumluluğu Insert Suitability		Stok Stock								
ISO TP.. 2204			Inter Cooland	D	Z	H	d	Uç Insert	Vida Screw	Anahtar Allen Key
TK TPKN 22 001 ISO	✓		X	63	3	48	22	TPKN 22	M8X1	A5
TK TPKN 22 002 ISO	✓		X	80	4	52	27			
TK TPKN 22 003 ISO	✓		X	80	4	52	32			
TK TPKN 22 004 ISO	✓		X	100	5	52	32			
TK TPKN 22 005 ISO	✓		X	125	6	62	32			
TK TPKN 22 006 ISO	✓		X	125	6	62	40			
TK TPKN 22 007 ISO	✓		X	160	7	62	40			
TK TPKN 22 008 ISO	✓		X	200	8	62	60			
TK TPKN 22 009 ISO	✓		X	250	10	62	60			



► 90° AP.. 1003 ISO

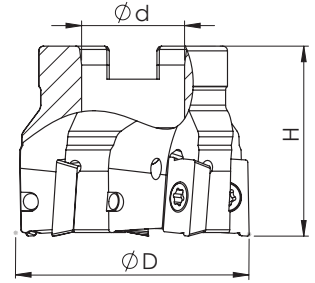

Kesici Uç Uyumluluğu Insert Suitability	Stok Stock	Inter Cooland	D	Z	H	d			
							Uç Insert	Vida Screw	Anahtar Allen Key
ISO AP.. 1003									
TK AP..10 001 ISO	✓	✓	40	5	45	16	AP..1003	M2.5X7	T08
TK AP..10 002 ISO	✓	✓	50	6	45	22			
TK AP..10 003 ISO	✓	✓	63	7	45	22			
TK AP..10 004 ISO	✓	✓	80	8	52	27			
TK AP..10 005 ISO	✓	✓	100	9	52	32			

► 90° APKT 16 ISO



Kesici Uç Uyumluluğu Insert Suitability	Stok Stock	Inter Cooland	D	Z	H	d			
							Uç Insert	Vida Screw	Anahtar Torx Key
ISO APKT 1604									
TK AP..16 001 ISO	✓	✓	40	4	45	16	AP..1604	M3.5X11	T15
TK AP..16 002 ISO	✓	✓	50	4	45	22			
TK AP..16 003 ISO	✓	✓	50	5	45	22			
TK AP..16 004 ISO	✓	✓	63	5	45	22			
TK AP..16 005 ISO	✓	✓	80	6	52	27			
TK AP..16 006 ISO	✓	✓	80	6	52	32			
TK AP..16 007 ISO	✓	✓	80	7	52	27			
TK AP..16 008 ISO	✓	✓	100	8	52	32			
TK AP..16 009 ISO	✓	✓	100	9	52	32			
TK AP..16 010 ISO	✓	X	125	8	62	40			
TK AP..16 011 ISO	✓	X	125	9	62	40			
TK AP..16 012 ISO	✓	X	160	10	62	40			
TK AP..16 013 ISO	✓	X	200	12	62	60			
TK AP..16 014 ISO	✓	X	250	14	62	60			

► 90° AN.. 1205

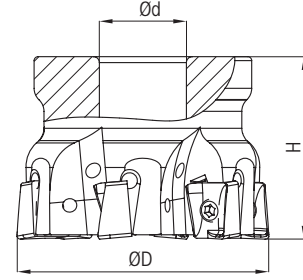

Kesici Uç Uyumluluğu Insert Suitability	Stok Stock	Inter Cooland	D	Z	H	d	Uç Insert	Vida Screw	Anahtar Torx Key
AN.. 1205									
TK AN.. 12 001	✓	✓	50	5	40	22	AN.. 1205	M4X14	T15
TK AN.. 12 002	✓	✓	63	6	45	22			
TK AN.. 12 003	✓	✓	80	7	52	27			
TK AN.. 12 004	✓	✓	100	8	52	32			

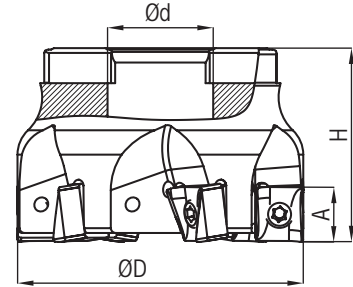

► 90° LNGX 1307 WLTR



Kesici Uç Uyumluluğu Insert Suitability	Stok Stock	Inter Cooland	D	Z	H	d	Uç Insert	Vida Screw	Anahtar Torx Key
WLTR LNGX 1307									
TK LNGX 13 001 WLTR	✓	✓	50	3	40	22	LNGX 1307..	M4X14	T15
TK LNGX 13 002 WLTR	✓	✓	63	4	45	22			
TK LNGX 13 003 WLTR	✓	✓	80	5	52	32			
TK LNGX 13 004 WLTR	✓	✓	100	8	52	32			
TK LNGX 13 005 WLTR	✓	✓	125	7	62	40			
TK LNGX 13 006 WLTR	✓	✓	160	8	62	40			
TK LNGX 13 007 WLTR	✓	✓	80	7	52	27			
TK LNGX 13 008 WLTR	✓	✓	50	4	40	22			
TK LNGX 13 009 WLTR	✓	✓	63	5	45	22			
TK LNGX 13 010 WLTR	✓	✓	125	10	62	40			

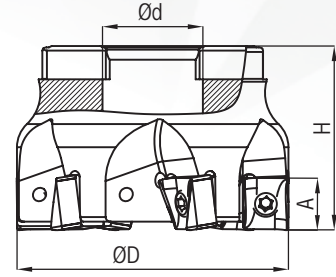

► 90° LNMX 1006/1510 KRLY

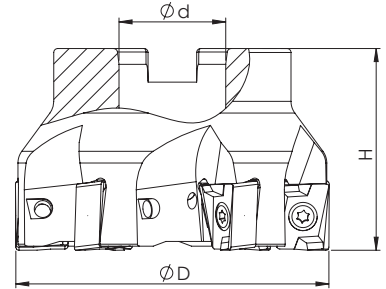

Kesici Uç Uyumluluğu Insert Suitability	Stok Stock	Inter Cooland	D	Z	H	d			
							Uç Insert	Vida Screw	Anahtar Torx Key
KRLY LNMX 1006/1510							LNMX 1006..	M3X10	T10
TK LNMX 10 001 KRLY	✓	✓	40	4	40	16			
TK LNMX 10 002 KRLY	✓	✓	40	5	40	16			
TK LNMX 10 003 KRLY	✓	✓	50	6	40	22			
TK LNMX 10 004 KRLY	✓	✓	50	4	40	22	LNMX 1510..	M4X14	T15
TK LNMX 15 005 KRLY	✓	✓	63	6	40	22			
TK LNMX 15 006 KRLY	✓	✓	80	7	52	27			
TK LNMX 15 007 KRLY	✓	✓	100	8	52	32			
TK LNMX 15 008 KRLY	✓	✗	125	10	62	40			
TK LNMX 15 009 KRLY	✓	✗	160	12	62	40			

► 90° LNGU 1607 PRMT

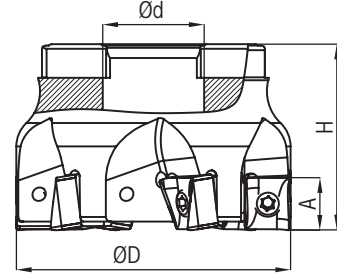

Kesici Uç Uyumluluğu Insert Suitability	Stok Stock	Inter Cooland	D	Z	H	d			
							Uç Insert	Vida Screw	Anahtar Torx Key
PRMT LNGU 1607							LNGU 1607..	M5X15	T20
TK LNGU 16 001 PRMT	✓	✓	63	4	45	22			
TK LNGU 16 002 PRMT	✓	✓	80	4	50	27			
TK LNGU 16 003 PRMT	✓	✓	100	5	50	32			
TK LNGU 16 004 PRMT	✓	✓	63	5	40	22			
TK LNGU 16 005 PRMT	✓	✓	80	6	50	27			
TK LNGU 16 006 PRMT	✓	✓	100	7	50	32			
TK LNGU 16 007 PRMT	✓	✗	125	8	62	40			
TK LNGU 16 008 PRMT	✓	✗	160	8	62	40			

► 90° LNGX 1205 WNDRT



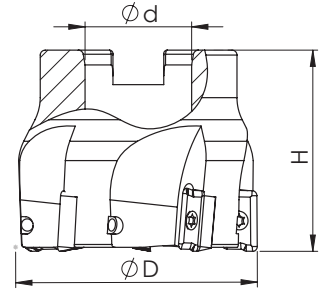

Kesici Uç Uyumluluğu Insert Suitability	Stok Stock	Inter Cooland	D	Z	H	d	Uç Insert	Vida Screw	Anahtar Torx Key
PRMT/VNDRT LNGX 1205									
TK LNGX 12 001 WNDRT	✓	✓	40	4	40	16	LNGX 1205..	M3,5X11	T15
TK LNGX 12 002 WNDRT	✓	✓	50	5	40	22			
TK LNGX 12 003 WNDRT	✓	✓	63	6	40	22			
TK LNGX 12 004 WNDRT	✓	✓	80	5	40	32			
TK LNGX 12 005 WNDRT	✓	✓	100	6	40	32			

► ADMT 1204 WLTR

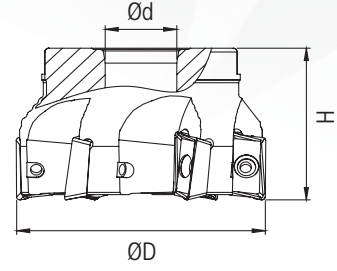
Kesici Uç Uyumluluğu Insert Suitability	Stok Stock	Inter Cooland	D	Z	H	d	Uç Insert	Vida Screw	Anahtar Torx Key
WLTR ADMT 1204									
TK ADMT 12 001 WLTR	✓	✓	40	4	40	16	ADMT 1204..	M3X9	T10
TK ADMT 12 002 WLTR	✓	✓	50	5	45	22			
TK ADMT 12 003 WLTR	✓	✓	63	6	45	22			



► 90° APKT 1204 TT





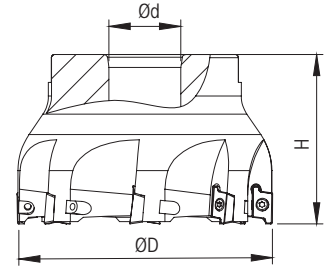
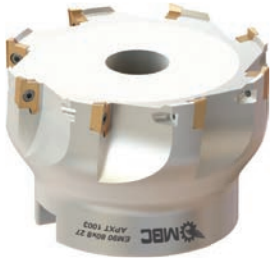

Kesici Uç Uyumluluğu Insert Suitability	Stok Stock	Inter Cooland	D	Z	H	d			
TT APKT 1204									
TK AP..12 001 TT	✓	✓	40	5	40	16	APKT 1204	M3,5x10	T15
TK AP..12 002 TT	✓	✓	50	6	40	22			
TK AP..12 003 TT	✓	✓	63	7	40	22			
TK AP..12 004 TT	✓	✓	80	8	52	27			

► 90° APXT 1003 KLP

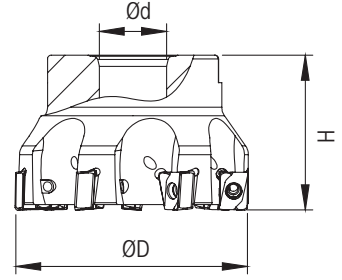



Kesici Uç Uyumluluğu Insert Suitability	Stok Stock	Inter Cooland	D	Z	H	d			
KLP APXT 1003									
TK APXT 10 001 KLP	✓	✓	40	5	40	16	APXT 1003	M2,5x7	T08
TK APXT 10 002 KLP	✓	✓	50	6	40	22			
TK APXT 10 003 KLP	✓	✓	63	7	50	22			
TK APXT 10 004 KLP	✓	✓	80	8	50	27			
TK APXT 10 005 KLP	✓	✓	80	8	50	32			

► 90° ANHG 1005 VNDRT

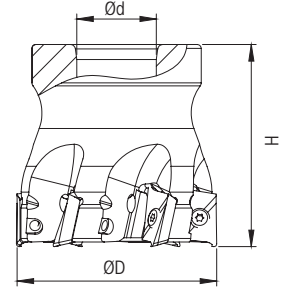



Kesici Uç Uyumluluğu Insert Suitability	Stok Stock	Inter Cooland	D	Z	H	d			
VNDRT ANHG 1005							Uç Insert	Vida Screw	Anahtar Torx Key
TK ANHG 10 001 VNDRT	✓	✓	40	4	40	16	ANHG 1005	M3x10	T10
TK ANHG 10 002 VNDRT	✓	✓	50	5	40	22			
TK ANHG 10 003 VNDRT	✓	✓	63	5	40	22			
TK ANHG 10 004 VNDRT	✓	✓	63	7	40	22			
TK ANHG 10 005 VNDRT	✓	✓	80	6	40	27			
TK ANHG 10 006 VNDRT	✓	✓	100	7	40	32			
TK ANHG 10 007 VNDRT	✓	✓	100	8	40	32			

► 90° AOMT 1236 MTSBSh

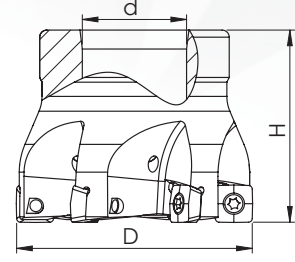
Kesici Uç Uyumluluğu Insert Suitability	Stok Stock	Inter Cooland	D	Z	H	d			
MTSBSh AOMT 1236							Uç Insert	Vida Screw	Anahtar Torx Key
TK AOMT 12 001 MTSBSh	✓	✓	40	6	40	16	AOMT 1236	M2,5x7	T08
TK AOMT 12 002 MTSBSh	✓	✓	50	7	40	22			
TK AOMT 12 003 MTSBSh	✓	✓	63	8	40	22			
TK AOMT 12 004 MTSBSh	✓	✓	80	9	40	27			
TK AOMT 12 005 MTSBSh	✓	✓	100	11	40	32			



► 90° P2840 WLTR

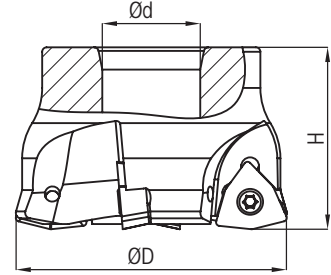

Kesici Uç Uyumluluğu Insert Suitability	Stok Stock	Inter Cooland	D	Z	H	d			
WLTR P2840							Uç Insert	Vida Screw	Anahtar Torx Key
TK P2840 001 WLTR	✓	✓	40	4	40	16	P-2840	M3,5x8	T15
TK P2840 002 WLTR	✓	✓	50	5	40	22			

► 90° XNKT 0805 KRLY

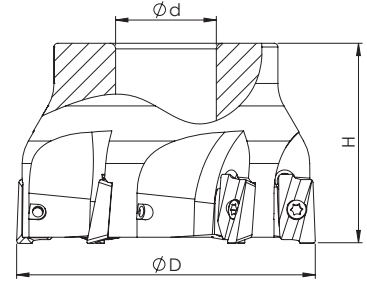

Kesici Uç Uyumluluğu Insert Suitability	Stok Stock	Inter Cooland	D	Z	H	d			
KRLY XNKT 0805							Uç Insert	Vida Screw	Anahtar Torx Key
TK XNKT 08 001 KRLY	✓	✓	40	4	40	16	XNKT 0805	M4x10	T15
TK XNKT 08 002 KRLY	✓	✓	50	5	45	22			
TK XNKT 08 003 KRLY	✓	✓	63	6	45	22			
TK XNKT 08 004 KRLY	✓	✓	80	7	50	27			
TK XNKT 08 005 KRLY	✓	✓	100	8	50	32			

► 90° R390 1806 SNDVK



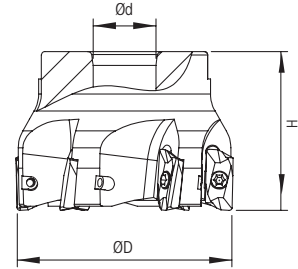

Kesici Uç Uyumluluğu Insert Suitability	Stok Stock	Inter Cooland	D	Z	H	d	Uç Insert	Vida Screw	Anahtar Torx Key
SNDVK R390 1806									
TK R390 18 001 SNDVK	✓	✓	50	4	40	22	R390 1806	M4x12	T15
TK R390 18 002 SNDVK	✓	✓	63	5	40	22			
TK R390 18 003 SNDVK	✓	✓	80	6	40	27			
TK R390 18 004 SNDVK	✓	✓	100	8	52	32			
TK R390 18 005 SNDVK	✓	X	160	10	52	40			

► 90° EDPT 1404/1805 KNNMTL

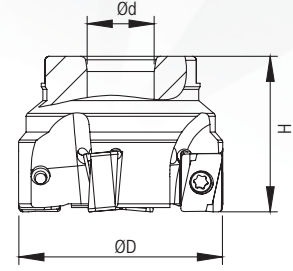
Kesici Uç Uyumluluğu Insert Suitability	Stok Stock	Inter Cooland	D	Z	H	d	Uç Insert	Vida Screw	Anahtar Torx Key
KNNMTL EDPT 1404/1805									
TK EDPT 14 001 KNNMTL	✓	✓	40	4	40	16	EDPT 1404	M3x8	T10
TK EDPT 14 002 KNNMTL	✓	✓	50	5	40	22			
TK EDPT 14 004 KNNMTL	✓	✓	63	6	50	22			
TK EDPT 14 005 KNNMTL	✓	✓	80	7	50	27			
TK EDPT 14 006 KNNMTL	✓	✓	100	8	50	32			
TK EDPT 18 007 KNNMTL	✓	✓	50	4	40	22	EDPT 1805	M3,5x10	T15
TK EDPT 18 008 KNNMTL	✓	✓	63	5	50	22			
TK EDPT 18 009 KNNMTL	✓	✓	80	6	50	27			

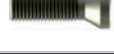

► 90° ANGX 1506 ZCC

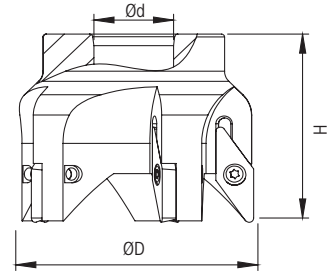

Kesici Uç Uyumluluğu Insert Suitability	Stok Stock	Inter Cooland	D	Z	H	d			
ZCC ANGX 1506							Uç Insert	Vida Screw	Anahtar Torx Key
TK ANGX 15 003 ZCC	✓	✓	50	4	45	22	ANGX 1506	M4x14	T15
TK ANGX 15 004 ZCC	✓	✓	63	5	45	22			
TK ANGX 15 005 ZCC	✓	✓	80	6	50	27			
TK ANGX 15 006 ZCC	✓	✓	100	8	55	32			

► 90° VCGT 1604/2205 ISO

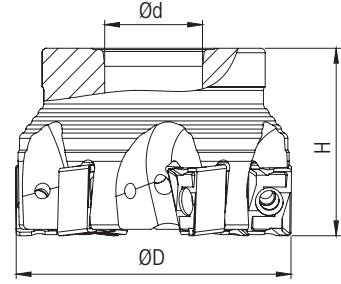

Kesici Uç Uyumluluğu Insert Suitability	Stok Stock	Inter Cooland	D	Z	H	d			
ISO VCGT 2205							Uç Insert	Vida Screw	Anahtar Torx Key
TK VCGT 22 001 ISO	✓	X	50	3	50	22	VCGT 22	M5X12	T20
TK VCGT 22 002 ISO	✓	X	63	3	60	22			
TK VCGT 22 003 ISO	✓	X	63	4	50	22			
TK VCGT 22 004 ISO	✓	X	80	5	52	27			

► 90° LNMX 1510 KLP



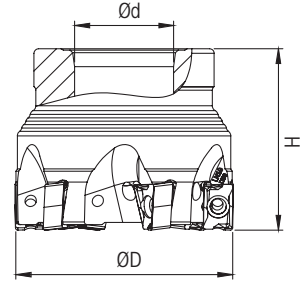

Kesici Uç Uyumluluğu Insert Suitability	Stok Stock	Inter Cooland	D	Z	H	d	Uç Insert	Vida Screw	Anahtar Torx Key
KLP LNMX 1510									
TK LNMX 15 003 KLP	✓	✓	50	5	40	22	LNMX 1510	M4X14	T15
TK LNMX 15 004 KLP	✓	✓	63	6	40	22			
TK LNMX 15 005 KLP	✓	✓	80	7	50	27			
TK LNMX 15 006 KLP	✓	✓	100	8	50	32			
TK LNMX 15 007 KLP	✓	x	125	10	63	40			

► 90° LNMX 1006 KLP

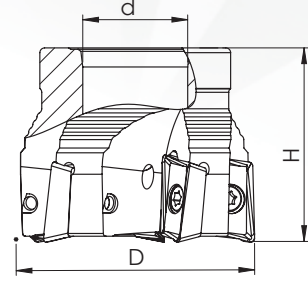
Kesici Uç Uyumluluğu Insert Suitability	Stok Stock	Inter Cooland	D	Z	H	d	Uç Insert	Vida Screw	Anahtar Torx Key
KLP LNMX 1006									
TK LNMX 10 001 KLP	✓	✓	40	5	40	16	LNMX 1006	M3X8	T10
TK LNMX 10 002 KLP	✓	✓	50	6	50	22			

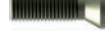

► 90° APKT 1604 KLP

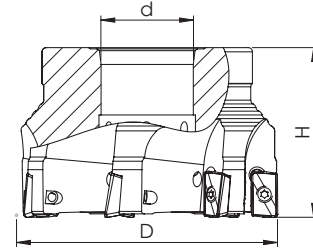
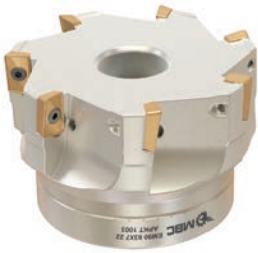

Kesici Uç Uyumluluğu Insert Suitability	Stok Stock	Inter Cooland	D	Z	H	d			
KLP APKT 1604							Uç Insert	Vida Screw	Anahtar Torx Key
TK APKT 16 001 KLP	✓	✓	40	4	40	16	APKT 1604	M4X10	T15
TK APKT 16 002 KLP	✓	✓	50	5	40	22			
TK APKT 16 003 KLP	✓	✓	63	6	40	22			
TK APKT 16 004 KLP	✓	✓	80	7	50	27			
TK APKT 16 005 KLP	✓	✓	100	8	50	32			

► 90° APKT 1003 KLP

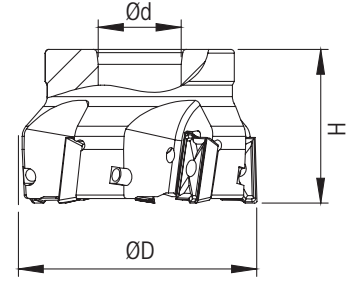

Kesici Uç Uyumluluğu Insert Suitability	Stok Stock	Inter Cooland	D	Z	H	d			
KLP APKT 1003							Uç Insert	Vida Screw	Anahtar Torx Key
TK APKT 10 001 KLP	✓	✓	40	5	40	16	APKT 1003	M2,5X7	T8
TK APKT 10 002 KLP	✓	✓	50	6	40	22			
TK APKT 10 003 KLP	✓	✓	63	7	40	22			

► 90° BDMT 1704 KYCR

Kesici Uç Uyumluluğu Insert Suitability	Stok Stock	Inter Cooland	D	Z	H	d	Uç Insert	Vida Screw	Anahtar Torx Key
KYCR BDMT 1704									
TK BDMT 17 001 KYCR	✓	✓	40	4	40	16	BDMT 1704	M4X12	T15
TK BDMT 17 002 KYCR	✓	✓	50	5	50	22			
TK BDMT 17 003 KYCR	✓	✓	63	5	50	22			
TK BDMT 17 004 KYCR	✓	✓	80	6	50	27			

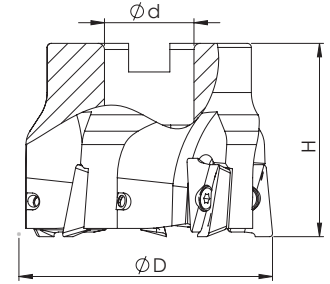
► 90° ADKT 1704 SNDVK

Kesici Uç Uyumluluğu Insert Suitability	Stok Stock	Inter Cooland	D	Z	H	d	Uç Insert	Vida Screw	Anahtar Torx Key
SNDVK R390 ADKT 1704									
TK ADKT 17 001 SNDVK	✓	✓	40	4	40	16	ADKT 1704	M3,5X11	T15
TK ADKT 17 002 SNDVK	✓	✓	50	4	45	22			
TK ADKT 17 003 SNDVK	✓	✓	63	5	45	22			
TK ADKT 17 004 SNDVK	✓	✓	80	6	52	27			

► 90° XNGU 15T6 WDA

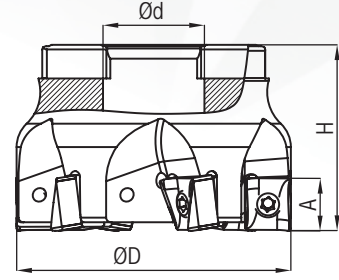

Kesici Uç Uyumluluğu Insert Suitability	Stok Stock	Inter Cooland	D	Z	H	d	Uç Insert	Vida Screw	Anahtar Torx Key
WDA XNGU 15T6									
TK XNGU 15 001 WDA	✓	✓	40	4	40	16	XNGU 15T6	M4X14	T15
TK XNGU 15 002 WDA	✓	✓	50	5	40	22			
TK XNGU 15 003 WDA	✓	✓	63	5	40	22			
TK XNGU 15 004 WDA	✓	✓	80	6	50	27			
TK XNGU 15 005 WDA	✓	✓	50	4	40	22			

► 90° APKT 11T3 ZCC

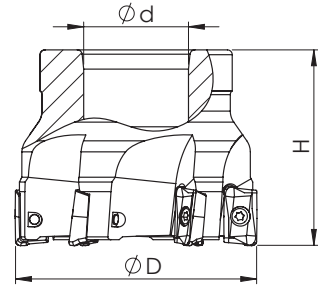

Kesici Uç Uyumluluğu Insert Suitability	Stok Stock	Inter Cooland	D	Z	H	d	Uç Insert	Vida Screw	Anahtar Torx Key
ZCC APKT 11T3									
TK APKT 11 001 ZCC	✓	✓	40	5	45	16	APKT 11T3	M2,5X7	T8
TK APKT 11 002 ZCC	✓	✓	50	6	50	22			
TK APKT 11 003 ZCC	✓	✓	63	7	50	22			

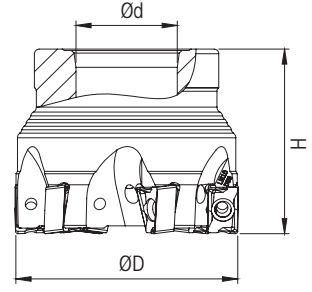
► 90° LOMU 1004 KYCR



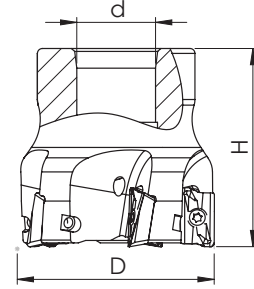

Kesici Uç Uyumluluğu Insert Suitability	Stok Stock	Inter Cooland	D	Z	H	d	Uç Insert	Vida Screw	Anahtar Torx Key
KYCR LOMU 1004									
TK LOMU 10 001 KYCR	✓	✓	50	5	45	22	LOMU 1004	M3,5X8	T15
TK LOMU 10 002 KYCR	✓	✓	63	6	50	22			
TK LOMU 10 003 KYCR	✓	✓	80	8	50	27			

► 90° BDMT 11T3 KYCR

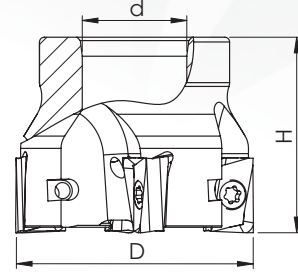
Kesici Uç Uyumluluğu Insert Suitability	Stok Stock	Inter Cooland	D	Z	H	d	Uç Insert	Vida Screw	Anahtar Torx Key
KYCR BDMT 11T3									
TK BDMT 11 001 KYCR	✓	✓	40	5	40	16	BDMT 11T3	M2,5X7	T8
TK BDMT 11 002 KYCR	✓	✓	50	6	40	22			



► 90° LOMU 1505 KYCR





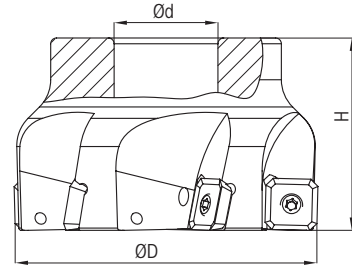

Kesici Uç Uyumluluğu Insert Suitability	Stok Stock	Inter Cooland	D	Z	H	d			
KYCR LOMU 1505							Uç Insert	Vida Screw	Anahtar Torx Key
TK LOMU 15 001 KYCR	✓	✓	50	4	40	22	LOMU 1505	M4X11	T15
TK LOMU 15 002 KYCR	✓	✓	63	5	40	22			
TK LOMU 15 003 KYCR	✓	✓	80	6	52	27			

► 90° SE.. 1203 ZCC/SNDVK

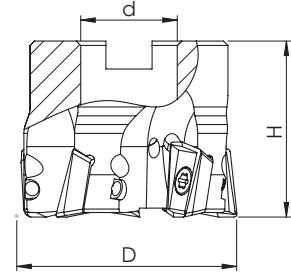



Kesici Uç Uyumluluğu Insert Suitability	Stok Stock	Inter Cooland	D	Z	H	d			
ZCC/SNDVK SEET 1203							Uç Insert	Vida Screw	Anahtar Torx Key
TK SEET 12 001 ZCC	✓	✓	50	4	40	22	SEET 1203	M3,5X11	T15
TK SEET 12 002 ZCC	✓	✓	63	5	40	22			
TK SEET 12 003 ZCC	✓	✓	80	6	50	27			
TK SEET 12 004 ZCC	✓	✓	100	7	50	32			
TK SEET 12 005 ZCC	✓	✓	125	8	62	40			

► 90° ADMX 1606 PRMT

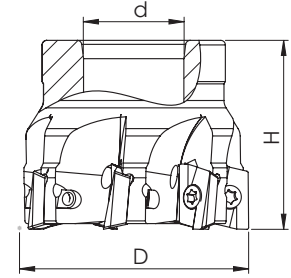



Kesici Uç Uyumluluğu Insert Suitability	Stok Stock	Inter Cooland	D	Z	H	d			
PRMT ADMX 1606							Uç Insert	Vida Screw	Anahtar Torx Key
TK ADMX 16 001 PRMT	✓	✓	50	4	40	22	ADMX 1606	M4X10	T15
TK ADMX 16 002 PRMT	✓	✓	50	5	40	22			
TK ADMX 16 003 PRMT	✓	✓	80	7	50	27			
TK ADMX 16 004 PRMT	✓	✓	100	6	52	32			

► 90° BOMT 1304 INGRSL

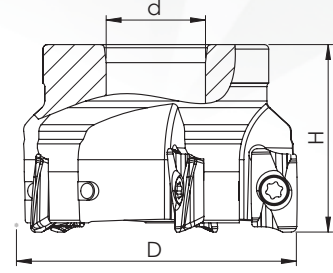
Kesici Uç Uyumluluğu Insert Suitability	Stok Stock	Inter Cooland	D	Z	H	d			
INGRSL BOMT 1304							Uç Insert	Vida Screw	Anahtar Torx Key
TK BOMT 13 001 INGRSL	✓	×	50	7	40	22	BOMT 1304	M3,5X8	T15
TK BOMT 13 002 INGRSL	✓	×	63	5	40	22			
TK BOMT 13 003 INGRSL	✓	×	63	8	40	22			
TK BOMT 13 004 INGRSL	✓	×	80	10	50	27			



► 90° AOMT 1605 INGRSL

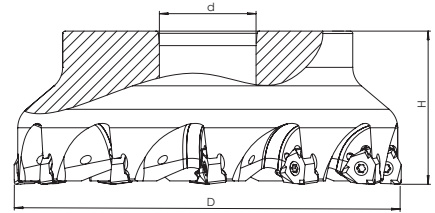

Kesici Uç Uyumluluğu Insert Suitability	Stok Stock	Inter Cooland	D	Z	H	d			
INGRSL AOMT 1605							Uç Insert	Vida Screw	Anahtar Torx Key
TK AOMT 16 001 INGRSL	✓	X	50	4	40	22	AOMT 1605	M4X11	T15
TK AOMT 16 002 INGRSL	✓	X	63	5	40	22			
TK AOMT 16 003 INGRSL	✓	X	80	6	50	27			
TK AOMT 16 004 INGRSL	✓	X	100	8	50	32			

► 90° XNEX 0806 VNDRT

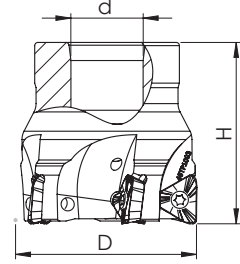

Kesici Uç Uyumluluğu Insert Suitability	Stok Stock	Inter Cooland	D	Z	H	d			
VNDRT XNEX 0806							Uç Insert	Vida Screw	Anahtar Torx Key
TK XNEX 08 002 VNDRT	✓	✓	50	4	40	22	XNEX 0806	M3,5X11	T15
TK XNEX 08 003 VNDRT	✓	✓	63	5	40	22			
TK XNEX 08 004 VNDRT	✓	✓	80	7	50	27			
TK XNEX 08 005 VNDRT	✓	✓	100	8	62	32			

► 90° TP.. 1003



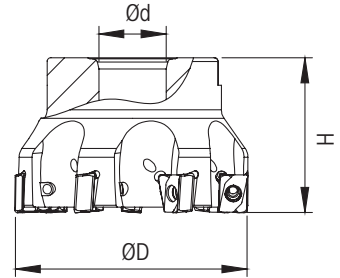

Kesici Uç Uyumluluğu Insert Suitability	Stok Stock	Inter Cooland	D	Z	H	d	Uç Insert	Vida Screw	Anahtar Torx Key
TP.. 1003									
TK TP.. 10 001	✓	✓	40	5	40	16	TP.. 1003	M3X8	T10
TK TP.. 10 002	✓	✓	50	6	40	22			
TK TP.. 10 003	✓	✓	63	7	40	22			

► 90° ANHG 1607 VNDRT

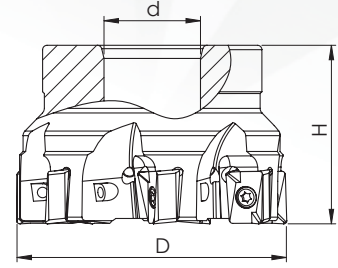
Kesici Uç Uyumluluğu Insert Suitability	Stok Stock	Inter Cooland	D	Z	H	d	Uç Insert	Vida Screw	Anahtar Torx Key
VNDRT ANHG 1607									
TK ANHG 16 001 VNDRT	✓	✓	50	4	40	22	ANHG 1607	M4X14	T15
TK ANHG 16 002 VNDRT	✓	✓	63	4	40	22			
TK ANHG 16 003 VNDRT	✓	✓	63	6	40	22			
TK ANHG 16 004 VNDRT	✓	✓	80	5	50	27			
TK ANHG 16 005 VNDRT	✓	✓	80	7	50	27			
TK ANHG 16 006 VNDRT	✓	✓	100	8	50	32			



► 90° ANGX 1105 ZCC

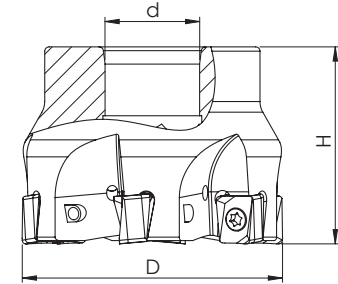

Kesici Uç Uyumluluğu Insert Suitability	Stok Stock	Inter Cooland	D	Z	H	d			
ZCC ANGX 1105							Uç Insert	Vida Screw	Anahtar Torx Key
TK ANGX 11 001 ZCC	✓	✓	50	6	40	22	ANGX 1105	M3X9	T10
TK ANGX 11 002 ZCC	✓	✓	63	7	40	22			

► 90° LQMU 1107 TNGLY

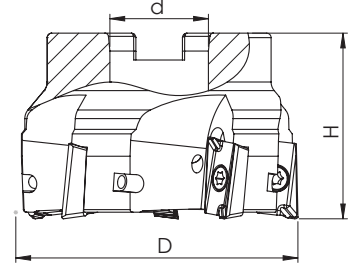

Kesici Uç Uyumluluğu Insert Suitability	Stok Stock	Inter Cooland	D	Z	H	d			
TNGLY LQMU 1107							Uç Insert	Vida Screw	Anahtar Torx Key
TK LQMU 11 001 TNGLY	✓	✓	50	5	40	22	LQMU 1107	M3,5X9	T15
TK LQMU 11 002 TNGLY	✓	✓	63	6	45	22			
TK LQMU 11 003 TNGLY	✓	✓	80	8	52	27			

► 90° APMT 1604 MES

Kesici Uç Uyumluluğu Insert Suitability	Stok Stock	Inter Cooland	D	Z	H	d	Uç Insert	Vida Screw	Anahtar Torx Key
MES APMT 1604									
TK APMT 16 001 MES	✓	✓	40	4	40	16	APMT 1604	M3,5X11	T15
TK APMT 16 002 MES	✓	✓	50	5	40	22			
TK APMT 16 003 MES	✓	✓	63	5	40	22			

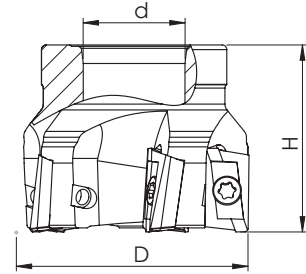
► 90° APKT 1604 ZCC

Kesici Uç Uyumluluğu Insert Suitability	Stok Stock	Inter Cooland	D	Z	H	d	Uç Insert	Vida Screw	Anahtar Torx Key
ZCC APKT 1604									
TK AP 16 001 ZCC	✓	×	40	4	40	16	APKT 1604	M4X12	T15
TK AP 16 002 ZCC	✓	×	50	5	40	22			
TK AP 16 003 ZCC	✓	×	63	5	40	22			

► 90° WNMU 0806 KYCR

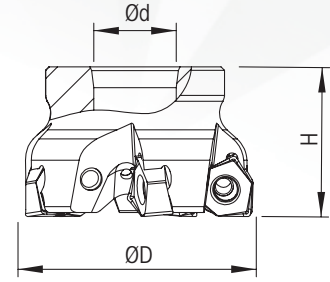

Kesici Uç Uyumluluğu Insert Suitability	Stok Stock	Inter Cooland	D	Z	H	d	Uç Insert	Vida Screw	Anahtar Torx Key
KYCR WNMU 0806									
TK WNMU 08 001 KYCR	✓	✓	50	4	40	22	WNMU 0806	M5X12	T20
TK WNMU 08 002 KYCR	✓	✓	52	4	40	22			
TK WNMU 08 003 KYCR	✓	✓	63	4	40	22			
TK WNMU 08 004 KYCR	✓	✓	63	5	40	22			
TK WNMU 08 005 KYCR	✓	X	80	5	45	27			
TK WNMU 08 006 KYCR	✓	X	80	6	45	27			
TK WNMU 08 007 KYCR	✓	✓	100	7	50	32			
TK WNMU 08 008 KYCR	✓	✓	125	8	50	40			
TK WNMU 08 009 KYCR	✓	✓	160	10	62	40			

► 90° WNHU 0806 ZCC

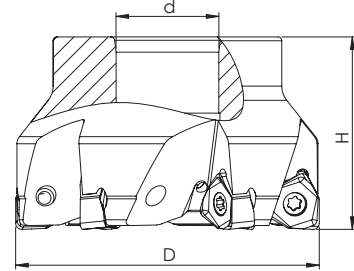

Kesici Uç Uyumluluğu Insert Suitability	Stok Stock	Inter Cooland	D	Z	H	d	Uç Insert	Vida Screw	Anahtar Torx Key
ZCC WNHU 0806									
TK WNHU 08 001 ZCC	✓	✓	50	4	40	22	WNHU 0806	M4X12	T15
TK WNHU 08 002 ZCC	✓	✓	63	5	40	22			
TK WNHU 08 003 ZCC	✓	✓	80	6	50	27			
TK WNHU 08 007 ZCC	X	X	200	14	62	60			
TK WNHU 08 008 ZCC	X	X	250	16	62	60			

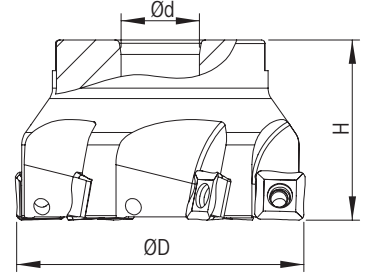
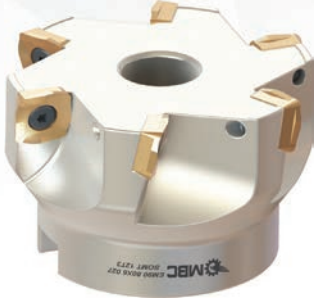
► 90° SOMT 12T3 MTSBSH



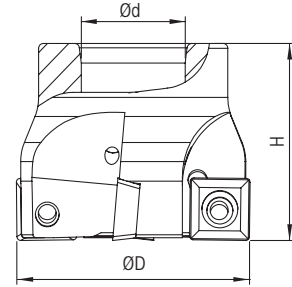

Kesici Uç Uyumluluğu Insert Suitability	Stok Stock	Inter Cooland	D	Z	H	d	Uç Insert	Vida Screw	Anahtar Torx Key
MTSBSH SOMT 12T3									
TK SOMT 12 001 MTSBSH	✓	✓	50	4	40	22	SOMT 12T3	M3,5x11	T15
TK SOMT 12 002 MTSBSH	✓	✓	63	5	45	22			
TK SOMT 12 003 MTSBSH	✓	✓	80	6	45	27			
TK SOMT 12 004 MTSBSH	✓	✓	100	7	50	32			
TK SOMT 12 005 MTSBSH	✓	X	100	10	50	32			
TK SOMT 12 006 MTSBSH	✓	X	125	8	50	40			
TK SOMT 12 007 MTSBSH	✓	X	125	12	50	40			

► 90° SPMT 1204 WLTR

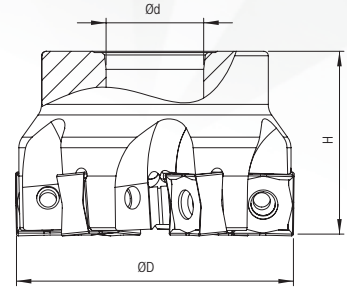
Kesici Uç Uyumluluğu Insert Suitability	Stok Stock	Inter Cooland	D	Z	H	d	Uç Insert	Vida Screw	Anahtar Torx Key
WLTR SPMT 1204									
TK SPMT 12 002 ISO	✓	✓	50	4	45	22	SPMT 1204	M4,5X12	T20
TK SPMT 12 003 ISO	✓	✓	63	5	50	22			
TK SPMT 12 004 ISO	✓	✓	80	6	50	27			



► 88° SNMX 1206 KRLY

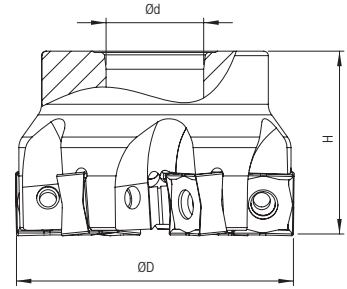

Kesici Uç Uyumluluğu Insert Suitability	Stok Stock	Inter Cooland	D	Z	H	d			
KRLY SNMX 1206							Uç Insert	Vida Screw	Anahtar Torx Key
TK SNMX 12 001 KRLY	✓	✓	50	5	40	22	SNMX 1206	M4,5X11	T20
TK SNMX 12 002 KRLY	✓	✓	63	6	40	22			
TK SNMX 12 003 KRLY	✓	✓	80	8	50	27			
TK SNMX 12 004 KRLY	✓	✓	100	10	50	32			
TK SNMX 12 005 KRLY	✓	✓	125	11	62	40			
TK SNMX 12 008 KRLY	X	X	250	18	62	60			

► 88° SNMX 1206 KLP

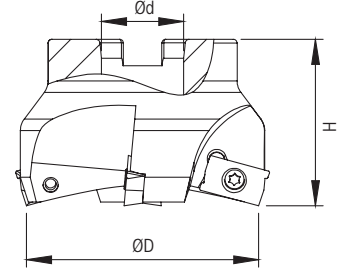

Kesici Uç Uyumluluğu Insert Suitability	Stok Stock	Inter Cooland	D	Z	H	d			
KLP SNMX 1206							Uç Insert	Vida Screw	Anahtar Torx Key
TK SNMX 12 001 KLP	✓	✓	50	5	40	22	SNMX 1206	M3,5X11	T15
TK SNMX 12 002 KLP	✓	✓	63	6	40	22			
TK SNMX 12 003 KLP	✓	✓	80	7	50	27			
TK SNMX 12 004 KLP	✓	✓	100	8	50	32			
TK SNMX 12 005 KLP	✓	X	125	10	62	40			

► 75° APKT 1604 ISO



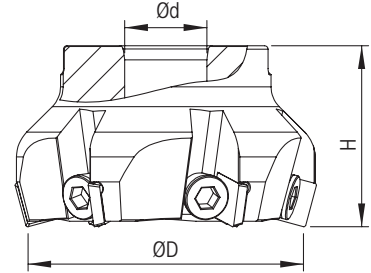
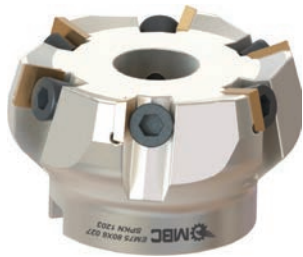

Kesici Uç Uyumluluğu Insert Suitability	Stok Stock	Inter Cooland	D	Z	H	d	Uç Insert	Vida Screw	Anahtar Torx Key
ISO APKT 1604									
TK EM 75 AP 16 001 ISO	✓	✓	63	4	40	22	APKT 1604	M3,5X9	T15
TK EM 75 AP 16 002 ISO	✓	✓	80	5	40	27			
TK EM 75 AP 16 003 ISO	✓	✓	100	6	40	32			
TK EM 75 AP 16 004 ISO	✓	x	125	7	52	40			

► 75° SPKN 1203/1504 ISO

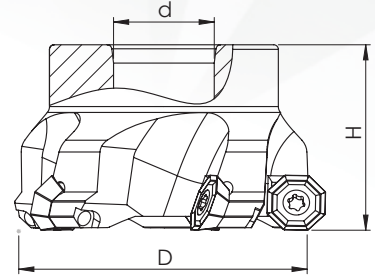
Kesici Uç Uyumluluğu Insert Suitability	Stok Stock	Inter Cooland	D	Z	H	d	Uç Insert	Vida Screw	Anahtar Allen Key
ISO SPKN 1203									
TK SPKN 12 001 ISO	✓	x	63	5	40	22	SPKN 1203	M8X1,25 (L)	A6
TK SPKN 12 002 ISO	✓	x	80	6	50	27			
TK SPKN 12 003 ISO	✓	x	100	8	50	32			
TK SPKN 12 004 ISO	✓	x	125	10	62	40			
TK SPKN 12 005 ISO	✓	x	160	12	62	40			
TK SPKN 12 006 ISO	✓	x	200	12	62	60			
TK SPKN 15 001 ISO	✓	x	125	10	62	40			



► 45° OFKT 05T3 ZCC

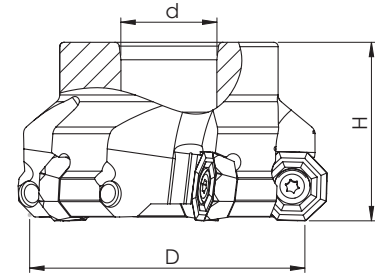

Kesici Uç Uyumluluğu Insert Suitability	Stok Stock	Inter Cooland	D	Z	H	d			
ZCC OFKT 05T3							Uç Insert	Vida Screw	Anahtar Torx Key
TK OFKT 05 001 ZCC	✓	✓	50	4	40	22	OFKT 05T3	M4X11	T15
TK OFKT 05 002 ZCC	✓	✓	63	5	40	22			
TK OFKT 05 003 ZCC	✓	✓	80	6	50	27			
TK OFKT 05 004 ZCC	✓	✓	100	7	50	32			

► 45° ODKT/ODHT 0605 ZCC



Kesici Uç Uyumluluğu Insert Suitability	Stok Stock	Inter Cooland	D	Z	H	d			
ZCC ODKT/ODHT 0605							Uç Insert	Vida Screw	Anahtar Torx Key
TK ODKT 06 001 ZCC	✓	✓	50	4	40	22	ODKT 0605	M5X12	T20
TK ODKT 06 002 ZCC	✓	✓	63	5	40	22			
TK ODKT 06 003 ZCC	✓	✓	80	6	50	27			
TK ODKT 06 004 ZCC	✓	✓	100	7	50	32			
TK ODKT 06 005 ZCC	✓	X	125	8	52	40			
TK ODKT 06 006 ZCC	✓	X	200	12	62	60			

► 45° OFMT 0706 ISO

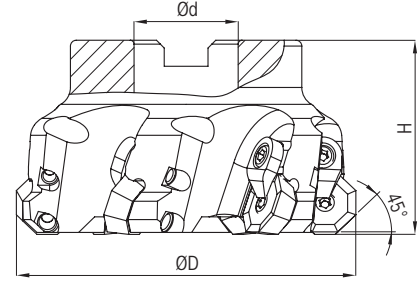

Kesici Uç Uyumluluğu Insert Suitability	Stok Stock	Inter Cooland	D	Z	H	d	Uç Insert	Vida Screw	Pabuç Clamp	Vida Screw	Anahtar Torx Key
ISO OFMT 0706											
TK OFMT 07 001 ISO	✓	✓	63	5	43	22	OFMT 0706	M5X12	C110105	M4X12	T20
TK OFMT 07 002 ISO	✓	✓	80	6	50	27					
TK OFMT 07 003 ISO	✓	✓	100	7	50	32					
TK OFMT 07 004 ISO	✓	x	125	8	62	40					
TK OFMT 07 005 ISO	✓	x	160	12	62	40					
TK OFPT 07 001 ISO	✓	x	160	12	62	40	OFPT 0706				

► 45° OFER 0704 LMN

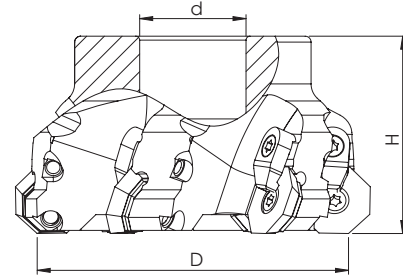

Kesici Uç Uyumluluğu Insert Suitability	Stok Stock	Inter Cooland	D	Z	H	d	Uç Insert	Vida Screw	Pabuç Clamp	Vida Screw	Anahtar Torx Key
LMN OFER 0704											
TK OFER 07 001 LT	✓	✓	80	6	50	27	OFER 0704	M5X12	C110105	M4X12	T20
TK OFER 07 002 LT	✓	✓	100	7	50	32					

► 45° ONKX 0806 LMN

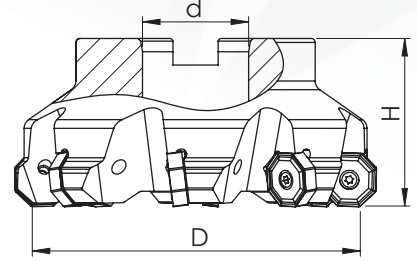
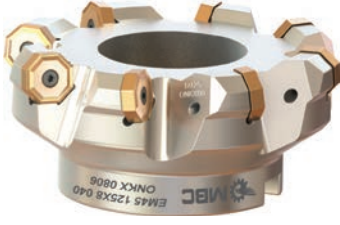

Kesici Uç Uyumluluğu Insert Suitability	Stok Stock	Inter Cooland	D	Z	H	d	Uç Insert	Vida Screw	Anahtar Torx Key
LMN ONKX 0806							ONKX 0806	M4,5X15	T20
TK ONKX 08 004 LT	✓	✓	80	6	50	27			
TK ONKX 08 005 LT	✓	✓	125	8	62	40			

► 45° ONHU 08T6 ZCC

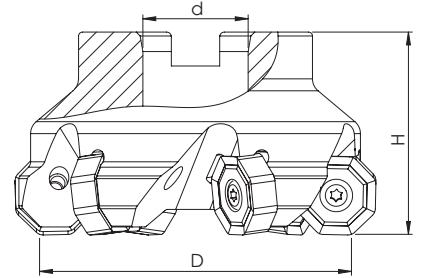

Kesici Uç Uyumluluğu Insert Suitability	Stok Stock	Inter Cooland	D	Z	H	d	Uç Insert	Vida Screw	Anahtar Torx Key
ZCC ONHU 08T6							ONHU 08T6	M4,5X15	T20
TK ONHU 08 001 ZCC	✓	✓	63	5	50	22			
TK ONHU 08 002 ZCC	✓	✓	80	6	50	27			
TK ONHU 08 003 ZCC	✓	✓	100	7	50	32			
TK ONHU 08 004 ZCC	✓	x	125	8	62	40			
TK ONHU 08 005 ZCC	✓	x	160	10	62	40			

► 45° ONHU 0806 ZCC

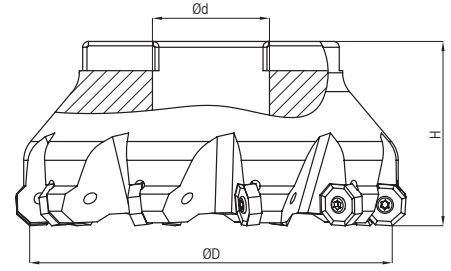

Kesici Uç Uyumluluğu Insert Suitability	Stok Stock	Inter Cooland	D	Z	H	d	Uç Insert	Vida Screw	Anahtar Torx Key
ZCC ONHU 0806							ONHU 0806	M4X12	T15
TK ONHU 0806 001 ZCC	X	✓	63	5	40	22			
TK ONHU 0806 002 ZCC	X	✓	80	6	50	27			
TK ONHU 0806 003 ZCC	X	✓	100	7	50	32			
TK ONHU 0806 004 ZCC	X	X	125	8	62	40			
TK ONHU 0806 005 ZCC	X	X	160	10	62	40			



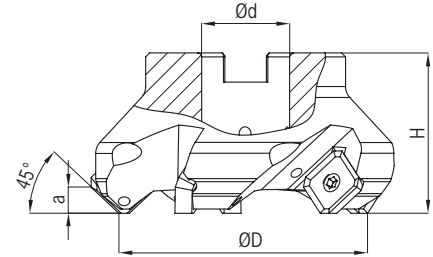

► 45° SE..12T3/SE 15.. ZCC-SNDVK

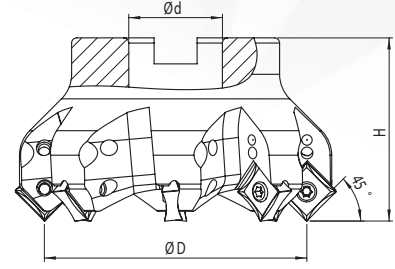

Kesici Uç Uyumluluğu Insert Suitability	Stok Stock	Inter Cooland	D	Z	H	d	Uç Insert	Vida Screw	Anahtar Torx Key
ZCC - SNDVK SEET 12T3/SE 15..							SE..12T3	M3,5X11	T15
TK SE.. 12 001 ZCC	✓	✓	50	4	40	22			
TK SE.. 12 002 ZCC	✓	✓	63	5	40	22			
TK SE.. 12 003 ZCC	✓	✓	80	6	50	27			
TK SE.. 12 004 ZCC	✓	✓	100	7	50	32			
TK SE.. 12 005 ZCC	✓	X	125	8	62	40			
TK SE.. 12 006 ZCC	✓	X	125	9	62	40			
TK SE.. 12 007 ZCC	✓	X	160	10	62	40			
TK SEET 15 008 ZCC	✓	✓	100	7	50	32			
TK SEET 15 009 ZCC	✓	X	125	8	62	40			
TK SEET 15 010 ZCC	✓	X	160	10	62	40			





► 45° SN.. 1206 KRLY

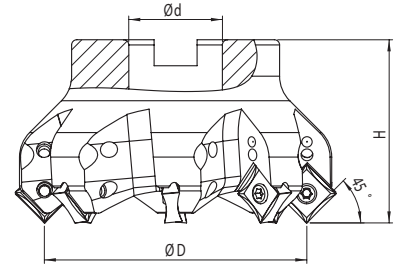

Kesici Uç Uyumluluğu Insert Suitability	Stok Stock	Inter Cooland	D	Z	H	d					
KRLY SN..1206											
TK SN.. 12 000 ISO	✓	✓	40	4	40	16	SN..1206	M4X12	CK15	M4X12	T15
TK SN.. 12 001 ISO	✓	✓	50	5	40	22					
TK SN.. 12 002 ISO	✓	✓	63	6	40	22					
TK SN.. 12 003 ISO	✓	✓	80	8	50	27					
TK SN.. 12 004 ISO	✓	✓	100	10	50	32					
TK SN.. 12 005 ISO	✓	X	125	11	62	40					
TK SN.. 12 006 ISO	✓	X	160	12	62	40					

► 45° SNMX 1206 KLP



Kesici Uç Uyumluluğu Insert Suitability	Stok Stock	Inter Cooland	D	Z	H	d					
KLP SNMX 1206											
TK SNMX 12 001 KLP	✓	✓	50	5	40	22	SNMX 1206	M4X12	CK15	M4X12	T15
TK SNMX 12 002 KLP	✓	✓	63	6	40	22					
TK SNMX 12 003 KLP	✓	✓	80	8	50	27					
TK SNMX 12 004 KLP	✓	✓	100	10	50	32					
TK SNMX 12 005 KLP	✓	X	125	11	62	40					

► 45° SNHG 1205 VNDRT

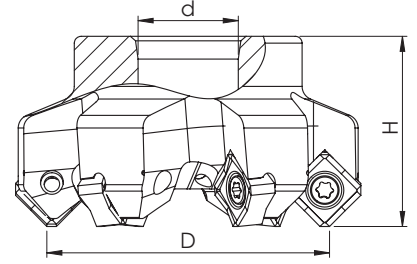

Kesici Uç Uyumluluğu Insert Suitability	Stok Stock	Inter Cooland	D	Z	H	d	Uç Insert	Vida Screw	Anahtar Torx Key
VNDRT SNHG 1205									
TK SNHG 12 001 VNDRT	✓	✓	50	6	40	22	SNHG 1205	M4X11	T15
TK SNHG 12 002 VNDRT	✓	✓	63	6	40	22			
TK SNHG 12 003 VNDRT	✓	✓	80	7	50	27			
TK SNHG 12 004 VNDRT	✓	✓	100	8	50	32			

► 45° SNKX 1205 LMN

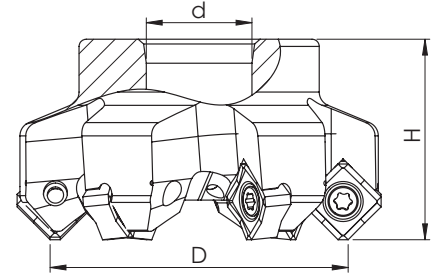

Kesici Uç Uyumluluğu Insert Suitability	Stok Stock	Inter Cooland	D	Z	H	d	Uç Insert	Vida Screw	Anahtar Torx Key
LMN SNKX 1205									
TK SNKX 12 001 LT	✓	✓	50	5	40	22	SNKX 1205	M4X11	T15
TK SNKX 12 002 LT	✓	✓	63	6	40	22			
TK SNKX 12 003 LT	✓	✓	80	7	50	27			
TK SNKX 12 004 LT	✓	✓	100	8	50	32			

► 45° SNEG 1205 ZCC

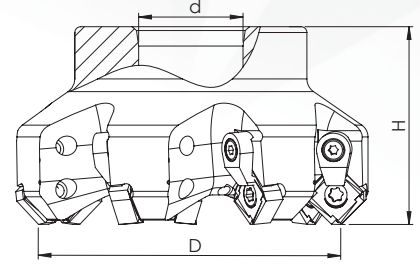

Kesici Uç Uyumluluğu Insert Suitability	Stok Stock	Inter Cooland	D	Z	H	d	Uç Insert	Vida Screw	Anahtar Torx Key
ZCC SNEG 1205							Uç Insert	Vida Screw	Anahtar Torx Key
TK SNEG 12 001 ZCC	✓	✓	63	6	40	22	SNEG 1205	M4X11	T15
TK SNEG 12 002 ZCC	✓	✓	80	7	50	27			
TK SNEG 12 003 ZCC	✓	X	125	10	62	40			

► 45° SN.. 1305

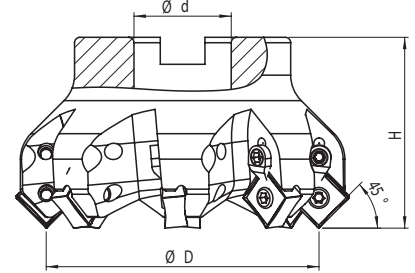

Kesici Uç Uyumluluğu Insert Suitability	Stok Stock	Inter Cooland	D	Z	H	d	Uç Insert	Vida Screw	Anahtar Torx Key
SN.. 1305							Uç Insert	Vida Screw	Anahtar Torx Key
TK SN..13 001	✓	✓	50	4	40	22	SN.. 1305	M4,5X12	T20
TK SN..13 002	✓	✓	63	6	40	22			
TK SN..13 003	✓	✓	80	7	50	27			
TK SN..13 004	✓	✓	100	8	50	32			
TK SN..13 005	✓	X	125	9	62	40			

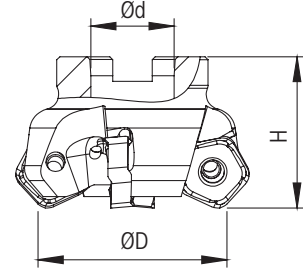
► 45° PNMU 0905/1205 KYCR

Kesici Uç Uyumluluğu Insert Suitability	Stok Stock	Inter Cooland	D	Z	H	d	Uç Insert	Vida Screw	Anahtar Torx Key
KYCR PNMU 0905/1205							PNMU 0905	M4X11	T15
TK PNMU 09 001 KYCR	✓	✓	63	5	40	22	PNMU 1205	M5X12	T20
TK PNMU 12 002 KYCR	✓	✓	50	4	40	22			
TK PNMU 12 003 KYCR	✓	✓	63	5	40	22			
TK PNMU 12 004 KYCR	✓	✓	80	5	45	27			
TK PNMU 12 005 KYCR	✓	✓	100	8	50	32			
TK PNMU 12 006 KYCR	✓	X	125	10	50	40			
TK PNMU 12 007 KYCR	✓	X	160	12	50	40			

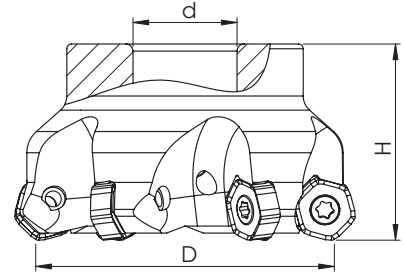
► 45° HNKX 0604 LMN

Kesici Uç Uyumluluğu Insert Suitability	Stok Stock	Inter Cooland	D	Z	H	d	Uç Insert	Vida Screw	Anahtar Torx Key
LMN HNKX 0604							HNKX 0604	M4X11	T15
TK HNKX 06 001 LT	✓	✓	50	5	40	22	HNKX 0604	M4X11	T15
TK HNKX 06 002 LT	✓	✓	63	6	40	22			
TK HNKX 06 003 LT	✓	✓	80	8	50	27			
TK HNKX 06 004 LT	✓	✓	100	9	50	32			
TK HNKX 06 005 LT	✓	X	125	12	62	40			
TK HNKX 06 006 LT	✓	X	160	12	62	40			
TK HNKX 06 007 LT	✓	X	160	14	62	40			

► 45° HN.. 0604 KNNMTL

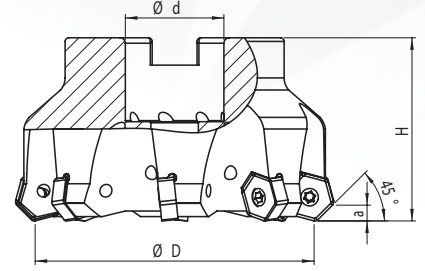

Kesici Uç Uyumluluğu Insert Suitability	Stok Stock	Inter Cooland	D	Z	H	d	Uç Insert	Vida Screw	Anahtar Torx Key
KNMTL HN..0604									
TK HN.. 06 001 KNM	✓	✓	50	4	40	22	HN.. 0604	M4X12	T15
TK HN.. 06 002 KNM	✓	✓	63	6	40	22			
TK HN.. 06 003 KNM	✓	✓	80	6	50	27			
TK HN.. 06 004 KNM	✓	✓	100	8	50	32			
TK HN.. 06 005 KNM	✓	X	125	10	62	40			

► 45° HNPJ 0704 WDA

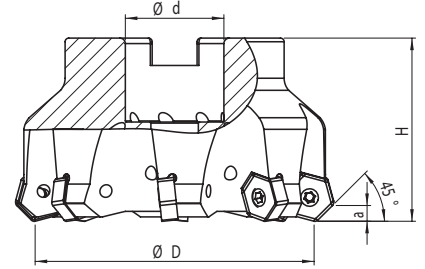

Kesici Uç Uyumluluğu Insert Suitability	Stok Stock	Inter Cooland	D	Z	H	d	Uç Insert	Vida Screw	Anahtar Torx Key
WDA HNPJ 0704									
TK HNPJ 07 001 WDA	✓	✓	50	4	40	22	HNPJ 0704	M4X12	T15
TK HNPJ 07 002 WDA	✓	✓	63	5	40	22			
TK HNPJ 07 003 WDA	✓	✓	63	6	40	22			
TK HNPJ 07 004 WDA	✓	✓	80	6	50	27			
TK HNPJ 07 005 WDA	✓	X	80	8	50	27			
TK HNPJ 07 006 WDA	✓	X	100	7	50	32			
TK HNPJ 07 007 WDA	✓	X	125	8	63	40			
TK HNPJ 07 008 WDA	✓	X	160	10	63	40			

► 45° HN.. 0906 PRMT

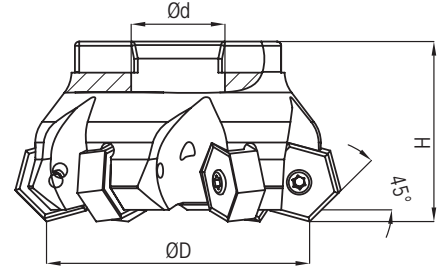

Kesici Uç Uyumluluğu Insert Suitability	Stok Stock	Inter Cooland	D	Z	H	d	Uç Insert	Vida Screw	Anahtar Torx Key
PRMT HN.. 0906									
TK HN.. 09 001 PRMT	✓	✓	50	4	40	22	HN..0906	M4X12	T15
TK HN.. 09 002 PRMT	✓	✓	63	4	40	22			
TK HN.. 09 003 PRMT	✓	✓	80	6	50	27			
TK HN.. 09 004 PRMT	✓	✓	100	8	50	32			
TK HN.. 09 005 PRMT	✓	X	125	10	62	40			
TK HN.. 09 006 PRMT	✓	X	160	12	62	40			
TK HN.. 09 007 PRMT	✓	X	200	10	62	60			
TK HN.. 09 008 PRMT	✓	X	250	12	62	60			
TK HN.. 09 009 PRMT	✓	X	300	14	62	60			

► 45° HNGJ 0905 WDA/KNMML

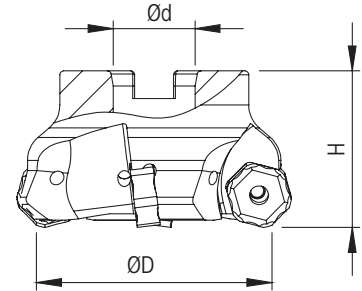

Kesici Uç Uyumluluğu Insert Suitability	Stok Stock	Inter Cooland	D	Z	H	d	Uç Insert	Vida Screw	Anahtar Torx Key
WDA-KNMML HNGJ 0905									
TK HN.. 09 001 KN WD	✓	✓	50	4	40	22	HNGJ 0905	M4X11	T15
TK HN.. 09 002 KN WD	✓	✓	63	4	40	22			
TK HN.. 09 003 KN WD	✓	✓	63	5	40	22			
TK HN.. 09 004 KN WD	✓	✓	80	6	50	27			
TK HN.. 09 005 KN WD	✓	✓	100	8	52	32			
TK HN.. 09 006 KN WD	✓	X	125	10	62	40			
TK HN.. 09 007 KN WD	✓	X	160	12	62	40			

► 44° ONMU 05 KLP

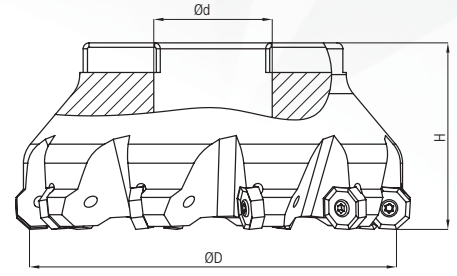

Kesici Uç Uyumluluğu Insert Suitability	Stok Stock	Inter Cooland	D	Z	H	d	Uç Insert	Vida Screw	Anahtar Torx Key
KLP ON.. 05							ON.. 05	M4,5X12	T20
TK ON.. 05 001	✓	✓	40	3	40	16			
TK ON.. 05 002	✓	✓	50	4	40	22			
TK ON.. 05 003	✓	✓	63	6	45	22			
TK ON.. 05 004	✓	✓	80	7	52	27			
TK ON.. 05 005	✓	X	100	8	52	32			
TK ON.. 05 006	✓	X	125	9	62	40			
TK ON.. 05 007	✓	X	160	9	62	40			

► 45° NNMU 2007 MTSBSH

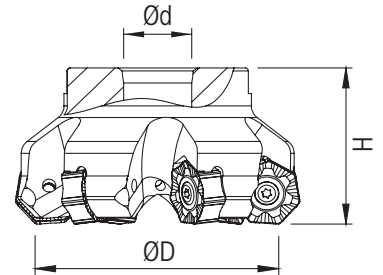
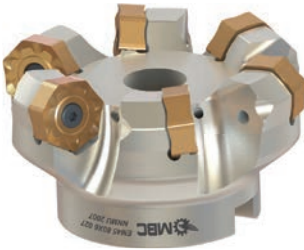

Kesici Uç Uyumluluğu Insert Suitability	Stok Stock	Inter Cooland	D	Z	H	d	Uç Insert	Vida Screw	Anahtar Torx Key
MTSBSH NNMU 2007							NNMU 2007	M5x12	T20
TK NNMU 20 001 MTSBSH	✓	✓	63	5	45	22			
TK NNMU 20 002 MTSBSH	✓	✓	80	6	45	27			
TK NNMU 20 003 MTSBSH	✓	✓	100	7	50	32			
TK NNMU 20 004 MTSBSH	✓	✓	125	8	50	40			
TK NNMU 20 005 MTSBSH	✓	X	160	10	55	40			
TK NNMU 20 006 MTSBSH	✓	X	200	12	55	60			
TK NNMU 20 007 MTSBSH	✓	X	200	12	55	60	NNMU 2006		



► SDMT 09T3 ZCC

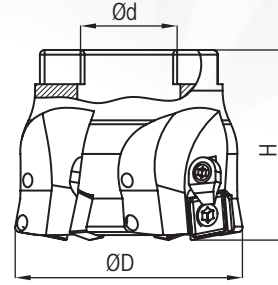

Kesici Uç Uyumluluğu Insert Suitability	Stok Stock	Inter Cooland	D	Z	H	d	Uç Insert	Vida Screw	Pabuç Clamp	Vida Screw	Anahtar Torx Key
ZCC SDMT 09T312											
TK SDMT 09 001 ZCC	✓	✓	40	4	40	16	SDMT 09T3	M3,5X11	CK14	M3,5X11	T15
TK SDMT 09 002 ZCC	✓	✓	50	4	40	22					
TK SDMT 09 003 ZCC	✓	✓	63	5	40	22					
TK SDMT 09 004 ZCC	✓	✓	50	5	40	22					
TK SDMT 09 005 ZCC	✓	✓	52	5	40	22					
TK SDMT 09 006 ZCC	✓	✓	52	6	40	22					
TK SDMT 09 007 ZCC	✓	✓	60	6	40	22					
TK SDMT 09 008 ZCC	✓	✓	63	6	40	22					

► SDMT 1204 ISO

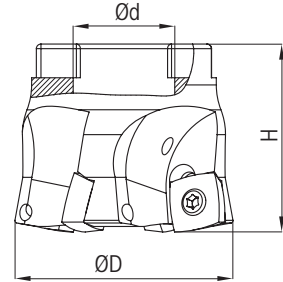

Kesici Uç Uyumluluğu Insert Suitability	Stok Stock	Inter Cooland	D	Z	H	d	Uç Insert	Vida Screw	Anahtar Torx Key
ISO SDMT 1204									
TK SDMT 12 001 ISO	✓	✓	52	4	40	22	SDMT 1204	M4X11	T15
TK SDMT 12 002 ISO	✓	✓	66	5	45	22			
TK SDMT 12 003 ISO	✓	✓	80	6	50	27			

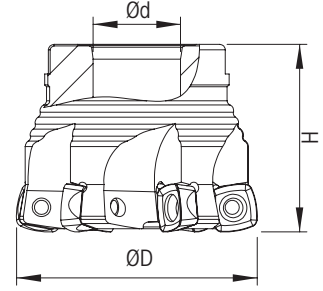
► SDMT 07/09/12 KLP



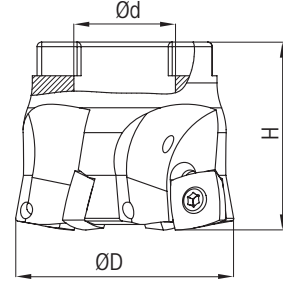

Kesici Uç Uyumluluğu Insert Suitability	Stok Stock	Inter Cooland	D	Z	H	d	Uç Insert	Vida Screw	Anahtar Torx Key
KLP SDMT 07/09/12							Uç Insert	Vida Screw	Anahtar Torx Key
TK SDMT 07 014 KLP	✓	✓	40	5	40	16	SDMT 07	M3,5x10	T15
TK SDMT 07 015 KLP	✓	✓	50	6	45	22			
TK SDMT 09 001 KLP	✓	✓	40	4	40	16	SDMT 09T3	M3,5x10	T15
TK SDMT 09 002 KLP	✓	✓	50	5	40	22			
TK SDMT 09 003 KLP	✓	✓	52	4	40	22			
TK SDMT 09 004 KLP	✓	✓	52	6	40	22			
TK SDMT 09 005 KLP	✓	✓	63	7	40	22			
TK SDMT 09 006 KLP	✓	✓	80	8	50	27			
TK SDMT 12 007 KLP	✓	✓	50	4	40	22	SDMT 1205	M4,5x12	T20
TK SDMT 13 008 KLP	✓	✓	52	5	40	22			
TK SDMT 14 009 KLP	✓	✓	63	5	40	22			
TK SDMT 15 010 KLP	✓	✓	63	6	40	22			
TK SDMT 12 011 KLP	✓	✓	66	5	50	27			
TK SDMT 12 012 KLP	✓	✓	66	6	50	27			
TK SDMT 12 013 KLP	✓	✓	80	7	50	27			

► ZDCW 09T3 ZDEW 1204 PRMT

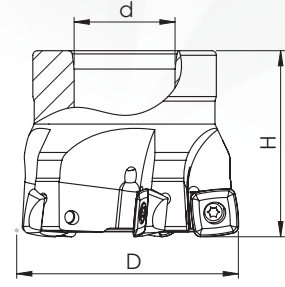
Kesici Uç Uyumluluğu Insert Suitability	Stok Stock	Inter Cooland	D	Z	H	d	Uç Insert	Vida Screw	Pabuç Clamp	Vida Screw	Anahtar Torx Key
PRMT ZDCW 09T3- ZDEW 1204							Uç Insert	Vida Screw	Pabuç Clamp	Vida Screw	Anahtar Torx Key
TK ZDCW 09 001 PRMT	✓	✓	40	4	40	16	ZDCW 09T304	M3X8	-	-	T10
TK ZDCW 12 002 PRMT	✓	✓	50	4	40	22	ZDEW 120408	M4X10	CK14	M4X10	T15
TK ZDCW 12 003 PRMT	✓	✓	63	5	40	22					



► SDMT 1004/1204 BHLR

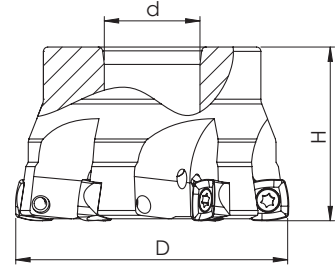

Kesici Uç Uyumluluğu Insert Suitability	Stok Stock	Inter Cooland	D	Z	H	d			
BHLR SDMT 1004/1204							Uç Insert	Vida Screw	Anahtar Torx Key
TK SDMT 10 002 BHLR	X	✓	50	5	40	22	SDMT 1004	M3X10	T10
TK SDMW 14 001 BHLR	X	✓	80	4	52	27	SDMW 14	M5X12	T20

► SDKX 0904 LMN

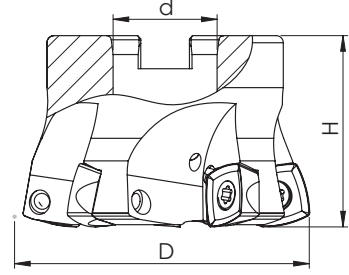

Kesici Uç Uyumluluğu Insert Suitability	Stok Stock	Inter Cooland	D	Z	H	d			
LMN SDKX 0904							Uç Insert	Vida Screw	Anahtar Torx Key
TK SDKX 09 001 LMN	✓	✓	40	5	40	16	SDKX 0904	M3,5X9	T15
TK SDKX 09 002 LMN	✓	✓	42	5	40	16			
TK SDKX 09 003 LMN	✓	✓	50	6	40	22			
TK SDKX 09 004 LMN	✓	✓	63	6	40	22			

► SDKX 1205 LMN

Kesici Uç Uyumluluğu Insert Suitability	Stok Stock	Inter Cooland	D	Z	H	d	Uç Insert	Vida Screw	Anahtar Torx Key
LMN SDKX 1205									
TK SDKX 12 001 LMN	✓	✓	50	5	40	22	SDKX 1205	M4X11	T15
TK SDKX 12 002 LMN	✓	✓	63	5	40	22			

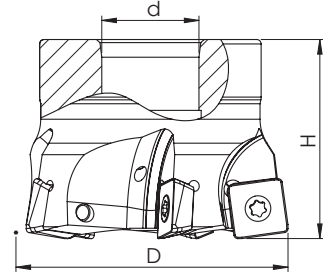
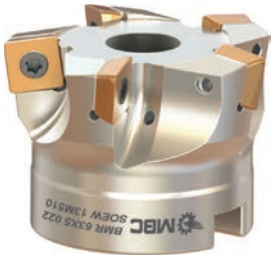
► SOEW 13M510 PLBT

Kesici Uç Uyumluluğu Insert Suitability	Stok Stock	Inter Cooland	D	Z	H	d	Uç Insert	Vida Screw	Anahtar Torx Key
PLBT SOEW 13M510									
TK SOEW 13 001 PLBT	✓	✓	52	4	40	22	SOEW 13	M4X10	T15
TK SOEW 13 002 PLBT	✓	✓	63	5	40	22			

► **SDMX 09T3 PLBT**

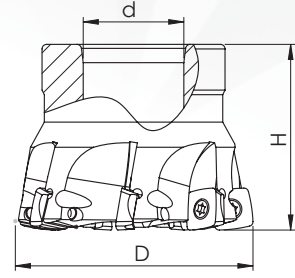

Kesici Uç Uyumluluğu Insert Suitability	Stok Stock	Inter Cooland	D	Z	H	d	Uç Insert	Vida Screw	Anahtar Torx Key
PLBT SDMX 09T3									
TK SDMX 09 001 PLBT	✓	X	42	6	40	16	SDMX 09T3	M3X8	T10
TK SDMX 09 002 PLBT	✓	X	52	7	40	22			
TK SDMX 09 003 PLBT	✓	X	80	9	50	27			

► **SOMT 1004/1404 KYCR**

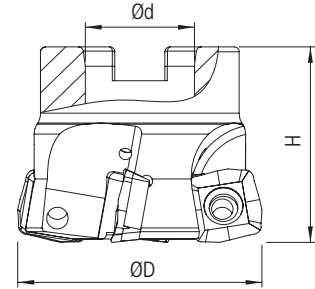

Kesici Uç Uyumluluğu Insert Suitability	Stok Stock	Inter Cooland	D	Z	H	d	Uç Insert	Vida Screw	Anahtar Torx Key
KYCR SOMT 1004/1404									
TK SOMT 10 001 KYCR	✓	✓	50	5	40	22	SOMT 1004	M4X10	T15
TK SOMT 10 002 KYCR	✓	✓	52	5	50	22			
TK SOMT 14 003 KYCR	✓	✓	50	4	40	22	SOMT 1404	M5X12	T20
TK SOMT 14 004 KYCR	✓	✓	52	4	50	22			
TK SOMT 14 005 KYCR	✓	✓	63	5	40	22			
TK SOMT 14 006 KYCR	✓	✓	80	6	60	27			

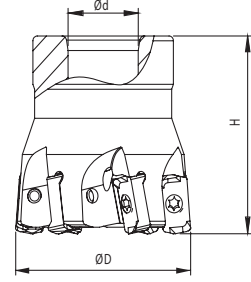
► LOGU 0303 KYCR



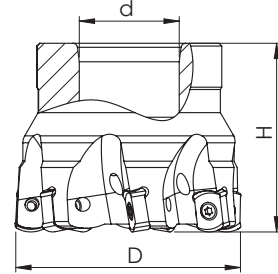

Kesici Uç Uyumluluğu Insert Suitability	Stok Stock	Inter Cooland	D	Z	H	d	Uç Insert	Vida Screw	Anahtar Torx Key
KYCR LOGU 0303									
TK LOGU 03 001 KYCR	✓	✓	40	6	40	17	LOGU 0303	M3X7	T8
TK LOGU 03 002 KYCR	✓	✓	50	7	50	22			
TK LOGU 03 003 KYCR	✓	✓	52	7	50	22			

► BLM 0603 TT

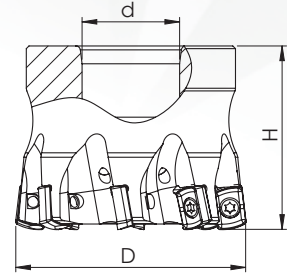
Kesici Uç Uyumluluğu Insert Suitability	Stok Stock	Inter Cooland	D	Z	H	d	Uç Insert	Vida Screw	Anahtar Torx Key
TT BLM 0603									
TK BLM 06 001 TT	×	✓	40	6	40	16	BLM 0603	M2,5X7	T8
TK BLM 06 002 TT	✓	✓	50	7	50	22			
TK BLM 06 003 TT	×	✓	63	8	50	22			



► LNMT 0603 KRLY





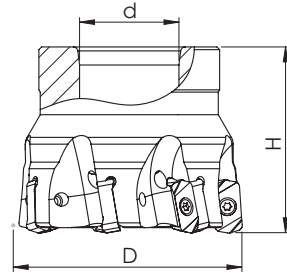

Kesici Uç Uyumluluğu Insert Suitability	Stok Stock	Inter Cooland	D	Z	H	d			
KRLY LNMT 0603							Uç Insert	Vida Screw	Anahtar Torx Key
TK LNMT 06 000 KRLY	✓	✓	40	7	40	16	LNMT 0603	M3X8	T10
TK LNMT 06 001 KRLY	✓	✓	52	8	40	22			
TK LNMT 06 002 KRLY	✓	✓	66	9	50	27			

► LNMU 0303 TNGLY

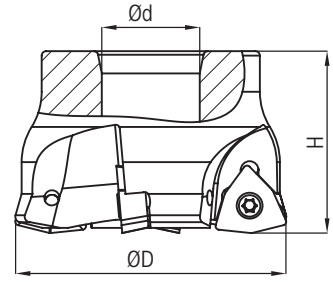



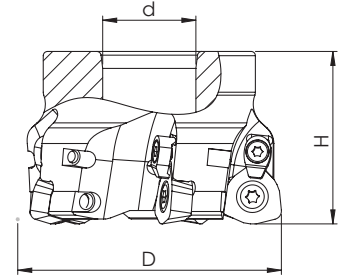

Kesici Uç Uyumluluğu Insert Suitability	Stok Stock	Inter Cooland	D	Z	H	d			
TNGLY LNMU 0303							Uç Insert	Vida Screw	Anahtar Torx Key
TK LNMU 03 002 TNG	✓	✓	50	7	40	22	LNMU 0303	M2,5X8	T8
TK LNMU 03 003 TNG	✓	✓	63	8	40	22			

► WNMX 09T3/1305 KRLY

Kesici Uç Uyumluluğu Insert Suitability	Stok Stock	Inter Cooland	D	Z	H	d			
KRLY WNMX 09T3 / 1305							Uç Insert	Vida Screw	Anahtar Torx Key
TK WNMX 09 001 KRLY	✓	✓	40	3	40	16	WNMX 09T316	M3X10	T10
TK WNMX 09 002 KRLY	✓	✓	40	4	40	16			
TK WNMX 09 003 KRLY	✓	✓	50	4	40	22			
TK WNMX 09 004 KRLY	✓	✓	52	4	40	22			
TK WNMX 09 005 KRLY	✓	✓	52	5	40	22			
TK WNMX 09 006 KRLY	✓	✓	52	6	40	22			
TK WNMX 09 007 KRLY	✓	✓	63	5	50	22			
TK WNMX 09 008 KRLY	✓	✓	66	6	50	22			
TK WNMX 09 009 KRLY	✓	✓	66	6	50	27			
TK WNMX 13 010 KRLY	✓	✓	50	3	40	22	WNMX 130520	M4X10	T15
TK WNMX 13 011 KRLY	✓	✓	63	4	40	22			
TK WNMX 13 012 KRLY	✓	✓	80	5	50	27			

► WDMT 0805 DJT

Kesici Uç Uyumluluğu Insert Suitability	Stok Stock	Inter Cooland	D	Z	H	d					
DJT WDMT 0805							Uç Insert	Vida Screw	Pabuç Clamp	Vida Screw	Anahtar Torx Key
TK WDMT 08 001 DJT	✓	✓	42	3	40	16	WDMT 0805	M4,5X15	CK15	M4X12	T20
TK WDMT 08 002 DJT	✓	✓	50	4	40	22					
TK WDMT 08 003 DJT	✓	✓	63	5	40	22					

► P26335 WLTR

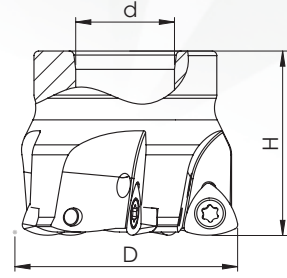

Kesici Uç Uyumluluğu Insert Suitability	Stok Stock	Inter Cooland	D	Z	H	d	Uç Insert	Vida Screw	Anahtar Torx Key
WLTR P26335									
TK P26335 001 WLTR	✓	✓	50	5	40	22	P26335R-14	M4x10	T15
TK P26335 002 WLTR	✓	✓	52	5	55	22			
TK P26335 003 WLTR	✓	✓	63	6	55	22	P26335R-25	M4,5x15	T20
TK P26335 004 WLTR	✓	✓	52	3	40	22			

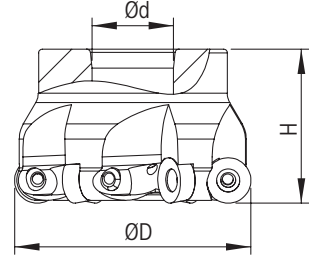

► RCKT 1204/1606 ZCC

Kesici Uç Uyumluluğu Insert Suitability	Stok Stock	Inter Cooland	D	Z	H	d	Uç Insert	Vida Screw	Anahtar Torx Key
ZCC RCKT 1204/1606									
TK RCKT 12 001 ZCC	✓	✓	50	5	40	22	RCKT 1204	M3,5x8	T15
TK RCKT 12 002 ZCC	✓	✓	63	6	40	22			
TK RCKT 16 003 ZCC	✓	✓	52	4	50	22	RCKT 1606	M6x15	T25
TK RCKT 16 004 ZCC	✓	✓	63	4	40	22			
TK RCKT 16 005 ZCC	✓	✓	80	5	50	27			

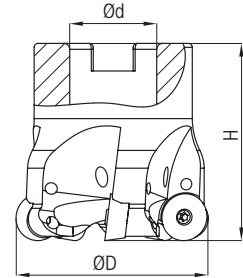
► RPMT 10T3 KYCR

Kesici Uç Uyumluluğu Insert Suitability	Stok Stock	Inter Cooland	D	Z	H	d	Uç Insert	Vida Screw	Anahtar Torx Key
KYCR RPMT 10T3									
TK RPMT 10 001 KYCR	✓	✓	35	4	40	16	RPMT 10T3	M3x8	T10
TK RPMT 10 002 KYCR	✓	✓	40	5	40	22			
TK RPMT 10 003 KYCR	✓	✓	50	6	40	22			

► RDKW 1003/12T3/1204/1604/2006 ISO

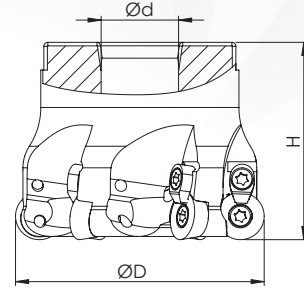

Kesici Uç Uyumluluğu Insert Suitability	Stok Stock	Inter Cooland	D	Z	H	d										
							Uç Insert	Vida Screw	Pabuç Clamp	Vida Screw	Anahtar Torx Key					
ISO RDKW 1003/12T3/1204/1604/2006																
TK RD..10 001 ISO	✓	✓	40	4	40	16	RDKW 1003	M3,5X10	CK14	M3,5X8	T15					
TK RD..10 002 ISO	✓	✓	50	5	46	22										
TK RD..10 003 ISO	✓	✓	63	6	50	22										
TK RD..10 004 ISO	✓	✓	80	7	52	27										
TK RD..10 005 ISO	✓	✓	100	8	52	32										
TK RD..12 006 ISO	✓	✓	40	4	40	16	RDKW 12T3	M3,5X10	CK14	M3,5X8	T15					
TK RD..12 007 ISO	✓	✓	50	5	46	22										
TK RD..12 008 ISO	✓	✓	52	5	46	22										
TK RD..12 009 ISO	✓	✓	63	6	50	22										
TK RD..12 010 ISO	✓	✓	80	7	52	27										
TK RD..12 011 ISO	✓	✓	100	8	52	32	RDKW 1204	M3,5X10	CK14	M3,5X8	T15					
TK RD..12 012 ISO	✓	✓	40	4	40	16										
TK RD..12 013 ISO	✓	✓	50	5	46	22										
TK RD..12 014 ISO	✓	✓	63	6	50	22										
TK RD..12 015 ISO	✓	✓	80	7	52	27										
TK RD..12 016 ISO	✓	✓	100	8	52	32	RDKW 1604	M5X12	TP11	M4X11	T20					
TK RD..16 017 ISO	✓	✓	52	4	50	22										
TK RD..16 018 ISO	✓	✓	63	4	50	22										
TK RD..16 019 ISO	✓	✗	66	5	50	27										
TK RD..16 020 ISO	✓	✗	80	5	52	27										
TK RD..16 021 ISO	✓	✗	100	6	52	32										
TK RD..16 022 ISO	✓	✗	125	7	62	40										
TK RD..16 023 ISO	✓	✗	160	8	62	40										
TK RD..16 024 ISO	✓	✗	180	11	62	60										
TK RD..16 025 ISO	✓	✗	200	12	62	60										

► RPMT 1204 KYCR

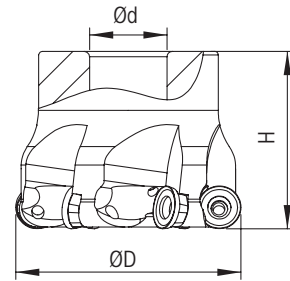



Kesici Uç Uyumluluğu Insert Suitability	Stok Stock	Inter Cooland	D	Z	H	d									
							Uç Insert	Vida Screw	Anahtar Torx Key						
KYCR RPMT 1204															
TK RPMT 12 001 KYCR	✓	✓	40	4	45	16	RPMT 1204	M4x10	T15						
TK RPMT 12 002 KYCR	✓	✓	52	3	50	22									
TK RPMT 12 003 KYCR	✓	✓	52	5	50	22									
TK RPMT 12 004 KYCR	✓	✓	63	6	50	22									
TK RPMT 12 005 KYCR	✓	✓	66	6	50	22									
TK RPMT 12 006 KYCR	✓	✓	66	6	50	27									



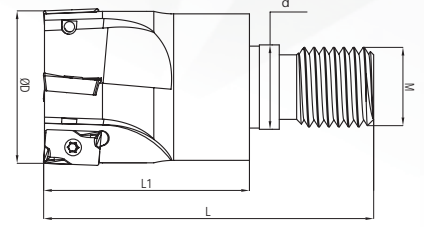



► 90° AP.. 1003/1604 ISO



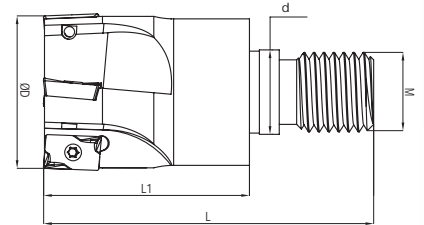



ISO AP.. 1003/1604	Kesici Uç Uyumluluğu Insert Suitability	Stok Stock	Inter Cooland	D	Z	L1	L	d	M			
										Uç Insert	Vida Screw	Anahtar Torx Key
VT AP..10 001 ISO	✓	✓	✓	25	3	28	50	12,5	M12	AP..1003	M2,5X7	T08
VT AP..10 002 ISO	✓	✓	✓	32	4	35	60	17	M16			
VT AP..10 003 ISO	✓	✓	✓	35	4	35	60	17	M16			
VT AP..10 004 ISO	✓	✓	✓	35	5	35	60	17	M16			
VT AP..10 005 ISO	✓	✓	✓	40	5	35	60	17	M16			
VT AP..10 006 ISO	✓	✓	✓	42	5	35	60	17	M16			
VT AP..16 007 ISO	✓	✓	✓	25	2	28	50	12,5	M12	AP..1604	M3,5X9	T15
VT AP..16 008 ISO	✓	✓	✓	32	3	35	60	17	M16			
VT AP..16 009 ISO	✓	✓	✓	40	4	35	60	17	M16			

► 90° APMT 11T3 ?

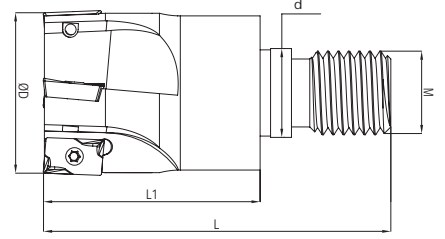



APMT 11T3	Kesici Uç Uyumluluğu Insert Suitability	Stok Stock	Inter Cooland	D	Z	L1	L	d	M			
										Uç Insert	Vida Screw	Anahtar Torx Key
VT APMT 11 001	X	✓	✓	20	3	36	60	10,5	M10	APMT 11T3	M2,5x7	T8
VT APMT 11 002	X	✓	✓	25	3	36	60	12,5	M12			
VT APMT 11 003	X	✓	✓	25	4	36	60	12,5	M12			
VT APMT 11 004	X	✓	✓	32	4	36	60	17	M16			
VT APMT 11 005	X	✓	✓	40	5	36	60	17	M16			

► 90° BDMT 11T3/1704 KYCR

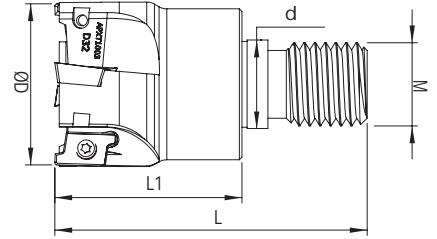



Kesici Uç Uyumluluğu Insert Suitability	Stok Stock	Inter Cooland	D	Z	L1	L	d	M	  			
									Uç Insert	Vida Screw	Anahtar Torx Key	
KYCR BDMT 11T3/1704												
VT BDMT 11 001 KYCR	✓	✓	20	3	28	50	10,5	M10	BDMT 11T3	M2,5x7	T08	
VT BDMT 11 002 KYCR	✓	✓	25	3	35	60	12,5	M12				
VT BDMT 11 003 KYCR	✓	✓	35	4	35	60	17	M16				
VT BDMT 17 004 KYCR	✓	✓	25	2	35	60	12,5	M12	BDMT 1704	M4x10	T15	
VT BDMT 17 005 KYCR	✓	✓	32	3	35	60	12,5	M12				

► 90° APXT 1003 KLP

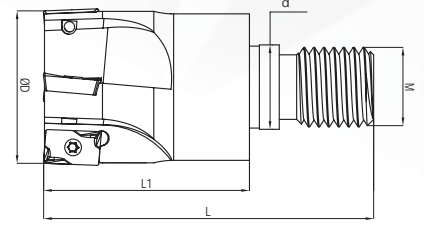
Kesici Uç Uyumluluğu Insert Suitability	Stok Stock	Inter Cooland	D	Z	L1	L	d	M	  			
									Uç Insert	Vida Screw	Anahtar Torx Key	
KLP APXT 1003												
VT APXT 10 001 KLP	✓	✓	25	3	28	50	12,5	M12	APXT 1003	M2,5x7	T8	
VT APXT 10 002 KLP	✓	✓	32	4	36	60	17	M16				
VT APXT 10 003 KLP	✓	✓	40	5	36	60	17	M16				



► 90° APKT 1003 KLP

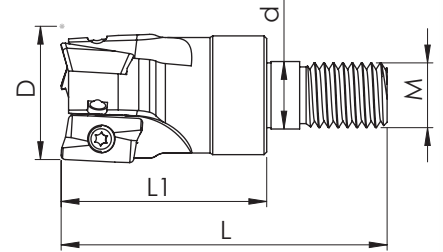

Kesici Uç Uyumluluğu Insert Suitability	Stok Stock	Inter Cooland	D	Z	L1	L	d	M	Uç Insert	Vida Screw	Anahtar Torx Key
KLP APKT 1003											
VT APKT 10 001 KLP	✓	✓	25	4	36	60	12,5	M12	APKT 1003	M2,5X7	T08
VT APKT 10 002 KLP	✓	✓	32	4	36	60	17	M16			
VT APKT 10 003 KLP	✓	✓	35	4	36	60	17	M16			
VT APKT 10 004 KLP	✓	✓	40	5	36	60	17	M16			

► 90° APKT 1704 KLP

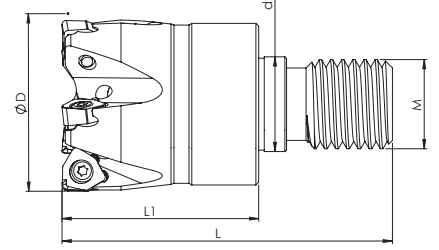

Kesici Uç Uyumluluğu Insert Suitability	Stok Stock	Inter Cooland	D	Z	L1	L	d	M	Uç Insert	Vida Screw	Anahtar Torx Key
KLP APKT 1704											
VT APKT 17 001 KLP	✓	✓	25	2	28	50	12,5	M12	APKT 1704	M3,5X11	T15
VT APKT 17 002 KLP	✓	✓	32	3	42	67	17	M16			
VT APKT 17 003 KLP	✓	✓	40	4	42	67	17	M16			

► 90° XNMX 0403 SCO

Kesici Uç Uyumluluğu Insert Suitability	Stok Stock	Inter Cooland	D	Z	L1	L	d	M	Uç Insert	Vida Screw	Anahtar Torx Key
SCO XNMX 0403											
VT XNMX 04 000 SCO	✓	✓	25	4	28	50	12,5	M12	XNMX 0403	M3X10	T10
VT XNMX 04 001 SCO	✓	✓	32	5	28	50	17	M16			
VT XNMX 04 002 SCO	✓	✓	40	6	28	50	17	M16			

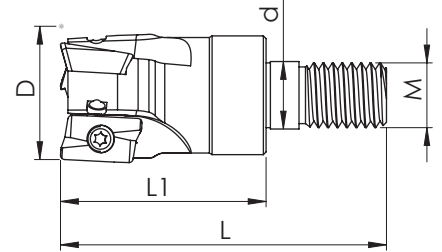
► 90° XOMX 1204 SCO

Kesici Uç Uyumluluğu Insert Suitability	Stok Stock	Inter Cooland	D	Z	L1	L	d	M	Uç Insert	Vida Screw	Anahtar Torx Key
SCO XOMX 1204..											
VT XOMX 12 001 SCO	✓	✓	25	3	36	60	12,5	M12	XOMX 1204	M3,5X8	T15
VT XOMX 12 002 SCO	✓	✓	32	4	36	60	17	M16			

► 90° BOMT 1304 INGRSL

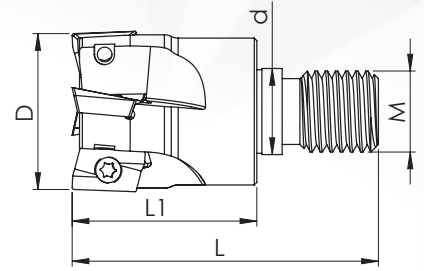

Kesici Uç Uyumluluğu Insert Suitability	Stok Stock	Inter Cooland	D	Z	L1	L	d	M	Uç Insert	Vida Screw	Anahtar Torx Key
INGRSL BOMT 1304											
VT BOMT 13 001 INGRSL	✓	✓	25	3	36	60	12,5	M12	BOMT 1304	M3,5X8	T15
VT BOMT 13 002 INGRSL	✓	✓	32	4	36	60	17	M16			



► 90° AOMT 1605 INGRSL

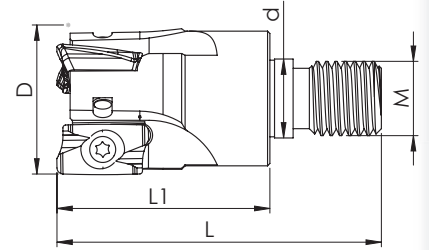

Kesici Uç Uyumluluğu Insert Suitability	Stok Stock	Inter Cooland	D	Z	L1	L	d	M	Uç Insert	Vida Screw	Anahtar Torx Key
INGRSL AOMT 160508											
VT AOMT 16 001 INGRSL	✓	✓	25	2	43	68	12,5	M12	AOMT 1605	M4X10	T15
VT AOMT 16 002 INGRSL	✓	✓	32	3	43	68	17	M16			
VT AOMT 16 003 INGRSL	✓	✓	40	4	43	68	17	M16			

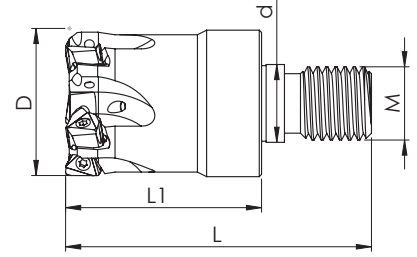

► 90° TNGX 1004 PRMT

Kesici Uç Uyumluluğu Insert Suitability	Stok Stock	Inter Cooland	D	Z	L1	L	d	M	Uç Insert	Vida Screw	Anahtar Torx Key
PRMT TNGX 1004											
VT TNGX 10 001 PRMT	✓	✓	25	4	33	55	12,5	M12	TNGX 1004	M2,5X7	T8
VT TNGX 10 002 PRMT	✓	✓	32	5	42	66	17	M16			

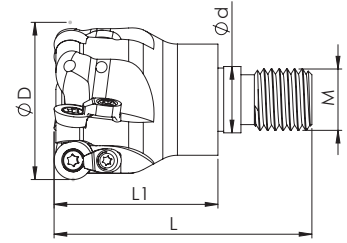
► RD.. 1003/12T3/1604 ISO

Kesici Uç Uyumluluğu Insert Suitability	Stok Stock	Inter Cooland	D	Z	L1	L	d	M	Uç Insert	Vida Screw	Pabuç Clamp	Vida Screw	Anahtar Torx Key
ISO RD.. 1003/12T3/1604													
VT RD..10 001 ISO	✓	✓	25	2	28	52	12,5	M12	RD..1003	M3,5X8	Ck14	M3,5X10	T15
VT RD..10 002 ISO	✓	✓	32	3	40	64	17	M16					
VT RD..10 003 ISO	✓	✓	32	4	40	64	17	M16					
VT RD..10 004 ISO	✓	✓	35	4	40	64	17	M16					
VT RD..10 005 ISO	✓	✓	40	4	43	67	17	M16					
VT RD..10 006 ISO	✓	✓	42	5	43	67	17	M16					
VT RD..12 007 ISO	✓	✓	25	2	28	52	12,5	M12	RD..12T3				
VT RD..12 008 ISO	✓	✓	32	3	40	64	17	M16					
VT RD..12 009 ISO	✓	✓	35	3	40	64	17	M16					
VT RD..12 010 ISO	✓	✓	40	4	40	64	17	M16					
VT RD..12 011 ISO	✓	✓	42	4	43	67	17	M16	RD..1604	M4,5X15			
VT RD..16 012 ISO	✓	✓	32	2	40	64	17	M16					
VT RD..16 013 ISO	✓	✓	40	2	40	67	17	M16					

► RHKX 10/12 KLP

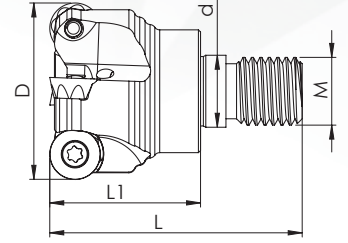

Kesici Uç Uyumluluğu Insert Suitability	Stok Stock	Inter Cooland	D	Z	L1	L	d	M	Uç Insert	Vida Screw	Anahtar Torx Key
KLP RHKX 10/12											
VT RHKX 10 001 KLP	✓	✓	32	4	35	60	17	M16	RHKX 10	M3,5X8	T15
VT RHKX 10 002 KLP	✓	✓	42	5	35	60	17	M16			
VT RHKX 12 003 KLP	✓	✓	32	3	35	60	17	M16	RHKX 12	M4X10	
VT RHKX 12 004 KLP	✓	✓	42	4	35	60	17	M16			

► RDHX 1003 KYCR

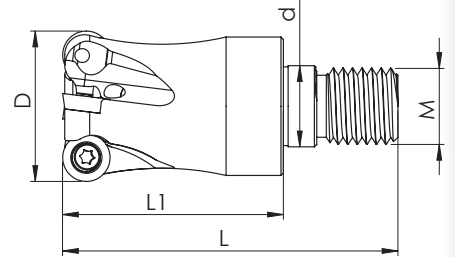

Kesici Uç Uyumluluğu Insert Suitability	Stok Stock	Inter Cooland	D	Z	L1	L	d	M	Uç Insert	Vida Screw	Anahtar Torx Key
KYCR RDHX 1003											
VT RDHX 10 001 KYCR	✓	✓	32	4	46	70	17	M16	RDHX 1003	M3,5X8	T15
VT RDHX 10 002 KYCR	✓	✓	42	5	46	70	17	M16			

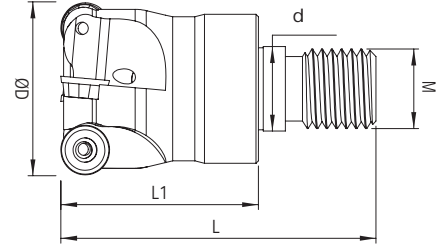
► RPMT 10T3 KYCR



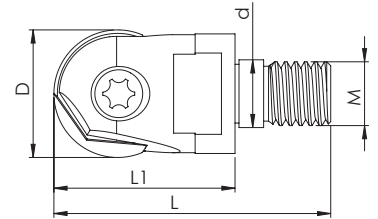

Kesici Uç Uyumluluğu Insert Suitability	Stok Stock	Inter Cooland	D	Z	L1	L	d	M	Uç Insert	Vida Screw	Anahtar Torx Key
KYCR RPMT 10T3											
VT RPMT 10 001 KYCR	✓	✓	25	3	36	60	12,5	M12	RPMT 10T3	M3X8	T10
VT RPMT 10 002 KYCR	✓	✓	32	3	36	60	17	M16			
VT RPMT 10 003 KYCR	✓	✓	32	4	36	60	17	M16			
VT RPMT 10 004 KYCR	✓	✓	35	4	36	60	17	M16			
VT RPMT 10 005 KYCR	✓	✓	40	4	36	60	17	M16			
VT RPMT 10 006 KYCR	✓	✓	42	5	36	60	17	M16			

► ZOHX 2005/2506/3207 ZCC

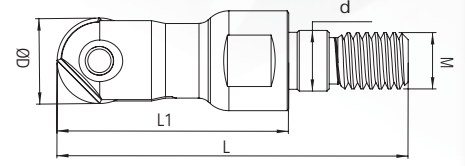
Kesici Uç Uyumluluğu Insert Suitability	Stok Stock	Inter Cooland	D	L1	L	d	M	Uç Insert	Vida Screw	Anahtar Torx Key
ZCC ZOHX 2005/2506/3207										
VT ZOHX 001 ZCC	✓	✓	32	45	70	17	M16	ZOHX 32	M8X25	T30
VT ZOHX 002 ZCC	✓	✓	25	35	60	17	M16	ZOHX 25	M6X22	T20
VT ZOHX 003 ZCC	✓	✓	20	30	50	17	M16	ZOHX 20	M5X16	



► ROHX 1203/1604 ZCC

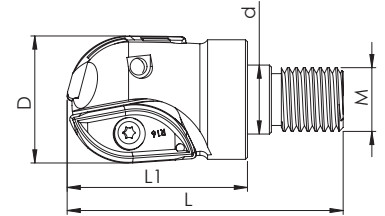

Kesici Uç Uyumluluğu Insert Suitability	Stok Stock	Inter Cooland	D	L1	L	d	M	Uç Insert	Vida Screw	Anahtar Torx Key
ZCC ROHX 1203/1604										
VT ROHX 12 001 ZCC	✓	X	12	41	67	8,5	M8	ROHX 1203	M4X12	T15
VT ROHX 16 002 ZCC	✓	X	16	41	67	8,5	M8	ROHX 1604	M5X16	T20
VT ROHX 16 003 ZCC	✓	X	20	41	67	10,5	M10	ROHX 2005	M5X20	

► XPHT 32 R16 ZCC

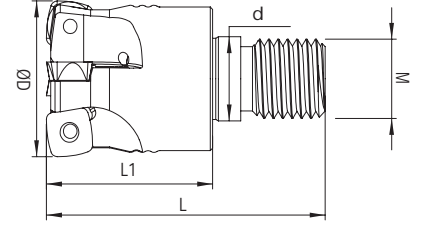

Kesici Uç Uyumluluğu Insert Suitability	Stok Stock	Inter Cooland	D	Z	L1	L	d	M	Uç Insert	Vida Screw	Anahtar Torx Key
ZCC XPHT 32 R16											
VT XPHT 001 ZCC	✓	✓	25	2	40	61	12,5	M12	XPHT R12	M4X10	T15
VT XPHT 002 ZCC	✓	✓	32	2	44	68	17	M16	XPHT R16	M5X12	T20

► SDMT 06T2/09T3/1204 ZCC

Kesici Uç Uyumluluğu Insert Suitability	Stok Stock	Inter Cooland	D	Z	L1	L	d	M	Uç Insert	Vida Screw	Anahtar Torx Key
ZCC SDMT 06T2/09T3/1204											
VT SDMT 06 001 ZCC	✓	✓	16	2	28	50	8,5	M8	SDMT 06T2	M3X10	T10
VT SDMT 06 002 ZCC	✓	✓	20	3	35	60	10,5	M10			
VT SDMT 06 003 ZCC	✓	✓	25	4	28	50	12,5	M12			
VT SDMT 09 004 ZCC	✓	✓	25	3	28	50	12,5	M12	SDMT 09T3	M3,5X8	T15
VT SDMT 09 005 ZCC	✓	✓	32	3	35	60	17	M16			
VT SDMT 09 006 ZCC	✓	✓	35	4	28	50	17	M16			
VT SDMT 09 007 ZCC	✓	✓	40	4	35	60	17	M16			
VT SDMT 09 008 ZCC	✓	✓	40	5	35	60	17	M16	SDMT 1204	M4X11	
VT SDMX 09 009 ZCC	✓	✓	42	4	28	50	17	M16			
VT SDMT 12 010 ZCC	✓	✓	42	4	28	50	17	M16			

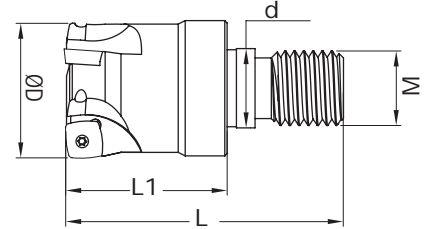
► SOEW 0803 PLBT

Kesici Uç Uyumluluğu Insert Suitability	Stok Stock	Inter Cooland	D	Z	L1	L	d	M	Uç Insert	Vida Screw	Anahtar Torx Key
PLBT SOEW 0803											
VT SOEW 08 001 PLBT	✓	✓	32	4	36	60	17	M16	SOEW 0803	M3X8	T10
VT SOEW 08 002 PLBT	✓	✓	35	4	36	60	17	M16			
VT SOEW 08 003 PLBT	✓	✓	40	5	36	60	17	M16			
VT SOEW 08 004 PLBT	✓	✓	25	3	36	60	17	M12			
VT SOEW 08 005 PLBT	✓	✓	42	5	36	60	17	M16			

► SDMX 09T3 PLBT

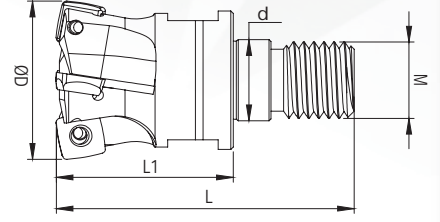



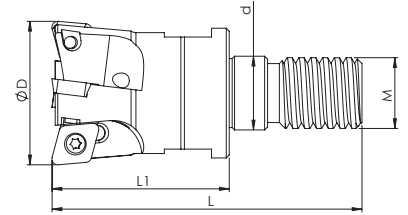

Kesici Uç Uyumluluğu Insert Suitability	Stok Stock	Inter Cooland	D	Z	L1	L	d	M	Uç Insert	Vida Screw	Anahtar Torx Key
PLBT SDMX 09T312											
VT SDMX 09 001 PLBT	✓	✓	25	3	28	50	12,5	M12	SDMX 09T3	M3X10	T10
VT SDMX 09 003 PLBT	✓	✓	32	4	35	60	17	M16			
VT SDMX 09 004 PLBT	✓	✓	35	5	35	60	17	M16			
VT SDMX 09 005 PLBT	✓	✓	42	6	35	60	17	M16			

► XDHW 04/06/09 PLBT

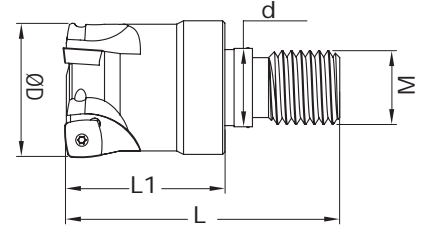



Kesici Uç Uyumluluğu Insert Suitability	Stok Stock	Inter Cooland	D	Z	L1	L	d	M	Uç Insert	Vida Screw	Anahtar Torx Key
PLBT XDHW 04/06/09											
VT XDHW 04 001 PLBT	X	✓	10	2	22	40	6,5	M6	XDHW 0401	M1,8X3,5	T6
VT XDHW 04 002 PLBT	✓	✓	12	3	22	40	6,5	M6			
VT XDHW 04 003 PLBT	✓	✓	16	4	25	42	8,5	M8			
VT XDHW 06 001 PLBT	✓	✓	16	2	25	42	8,2	M8	XDHW 0602	M2,5X7	T8
VT XDHW 06 002 PLBT	✓	✓	25	3	30	52	12,5	M12			
VT XDHW 06 003 PLBT	✓	✓	32	5	35	62	17	M16			
VT XDHW 06 004 PLBT	✓	✓	35	5	35	62	17	M16			
VT XDHW 06 005 PLBT	✓	✓	20	3	30	52	10,5	M10			
VT XDHW 06 006 PLBT	✓	✓	42	6	30	62	17	M16			
VT XDHW 06 007 PLBT	✓	✓	25	4	30	52	12,5	M12	XDHW 09T3	M4X10	T15
VT XDHW 09 001 PLBT	✓	✓	25	2	28	50	12,5	M12			
VT XDHW 09 002 PLBT	✓	✓	32	3	35	60	17	M16			
VT XDHW 09 003 PLBT	✓	✓	42	4	42	65	17	M16			

► SP.. 08T3 PLBT

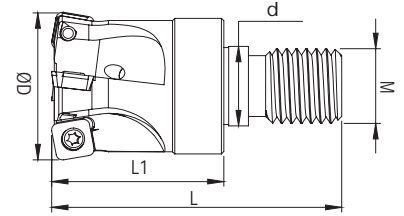
Kesici Uç Uyumluluğu Insert Suitability		Stok Stock							  			
PLBT SP.. 08T3			Inter Cooland	D	Z	L1	L	d	M	Uç Insert	Vida Screw	Anahtar Torx Key
VT SP.. 08 001 PLBT	✓	✓	✓	25	3	28	50	12,5	M12	SP..08T3	M3X10	T10
VT SP.. 08 002 PLBT	✓	✓	✓	32	3	35	60	17	M16			
VT SP.. 08 003 PLBT	✓	✓	✓	42	5	35	60	17	M16			

► SOMW/SOMT 0803 PLBT

Kesici Uç Uyumluluğu Insert Suitability		Stok Stock							  			
PLBT SOMT/SOMW 080315			Inter Cooland	D	Z	L1	L	d	M	Uç Insert	Vida Screw	Anahtar Torx Key
VT SOMW 08 001 PLBT	✓	✓	✓	20	2	36	60	10,5	M10	SOMT SOMW 0803	M3X8	T10
VT SOMW 08 002 PLBT	✓	✓	✓	25	3	36	60	12,5	M12			
VT SOMW 08 003 PLBT	✓	✓	✓	32	4	36	60	17	M16			
VT SOMW 08 004 PLBT	✓	✓	✓	42	5	36	60	17	M16			

► WNMX 09T3 KRLY

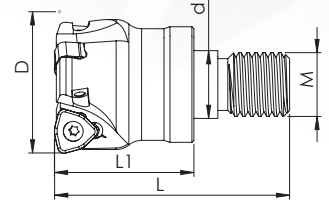

Kesici Uç Uyumluluğu Insert Suitability	Stok Stock	Inter Cooland	D	Z	L1	L	d	M	Uç Insert	Vida Screw	Anahtar Torx Key
KRLY WNMX 09T316											
VT WNMX 09 001 KRLY	✓	✓	25	2	28	50	12,5	M12	WNMX 09T3	M3X10	T10
VT WNMX 09 002 KRLY	✓	✓	32	3	38	60	17	M16			
VT WNMX 09 003 KRLY	✓	✓	35	3	38	60	17	M16			
VT WNMX 09 004 KRLY	✓	✓	35	4	38	60	17	M16			
VT WNMX 09 005 KRLY	✓	✓	40	4	38	60	17	M16			

► WNMX 0603 KRLY

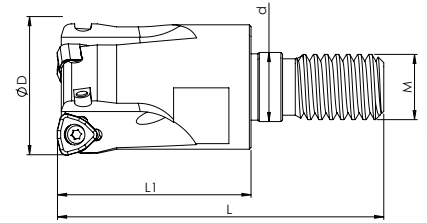

Kesici Uç Uyumluluğu Insert Suitability	Stok Stock	Inter Cooland	D	Z	L1	L	d	M	Uç Insert	Vida Screw	Anahtar Torx Key
KRLY WNMX 060312											
VT WNMX 06 001 KRLY	✓	✓	16	2	25	42	8,5	M8	WNMX 0603	M2,5X8	T08
VT WNMX 06 002 KRLY	✓	✓	20	3	35	60	10,5	M10			
VT WNMX 06 003 KRLY	✓	✓	25	3	35	60	12,5	M12			
VT WNMX 06 004 KRLY	✓	✓	25	4	35	60	12,5	M12			
VT WNMX 06 005 KRLY	✓	✓	35	5	35	60	17	M16			

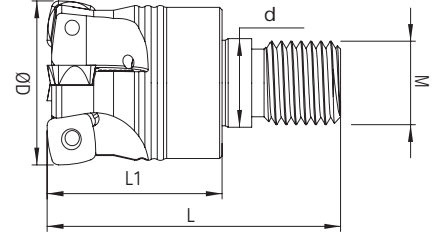
► SDMT 0703/09T3 KLP

Kesici Uç Uyumluluğu Insert Suitability	Stok Stock	Inter Cooland	D	Z	L1	L	d	M	Uç Insert	Vida Screw	Anahtar Torx Key
KLP SDMT 070308/09T312											
VT SDMT 07 001 KLP	✓	✓	20	2	28	50	10,5	M10	SDMT 0703	M3x8	T10
VT SDMT 07 002 KLP	✓	✓	25	3	28	50	12,5	M12			
VT SDMT 07 003 KLP	✓	✓	25	2	28	50	12,5	M12			
VT SDMT 07 004 KLP	✓	✓	32	4	35	60	17	M16			
VT SDMT 09 001 KLP	✓	✓	25	2	28	50	12,5	M12	SDMT 09T3	M3,5x10	T15
VT SDMT 09 002 KLP	✓	✓	32	3	35	60	17	M16			
VT SDMT 09 003 KLP	✓	✓	32	4	35	60	17	M16			
VT SDMT 09 004 KLP	✓	✓	35	4	35	60	17	M16			
VT SDMT 09 005 KLP	✓	✓	42	4	35	60	17	M16			
VT SDMT 09 006 KLP	✓	✓	40	5	35	60	17	M16			
VT SDMT 09 007 KLP	✓	✓	42	5	35	60	17	M16			

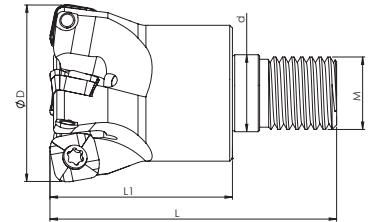
► SOMT 1004/1404 KYCR

Kesici Uç Uyumluluğu Insert Suitability	Stok Stock	Inter Cooland	D	Z	L1	L	d	M	Uç Insert	Vida Screw	Anahtar Torx Key
KYCR SOMT 1004/1404											
VT SOMT 10 001 KYCR	✓	✓	32	3	40	63	17	M16	SOMT 1004	M4X10	T15
VT SOMT 10 002 KYCR	✓	✓	35	3	40	63	17	M16			
VT SOMT 10 003 KYCR	✓	✓	40	4	40	63	17	M16			
VT SOMT 10 004 KYCR	✓	✓	42	4	40	63	17	M16			
VT SOMT 14 005 KYCR	✓	✓	42	3	40	63	17	M16	SOMT 1404	M5X12	T20

► LOGU 0303 KYCR

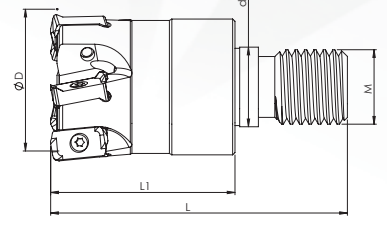

Kesici Uç Uyumluluğu Insert Suitability	Stok Stock	Inter Cooland	D	Z	L1	L	d	M	Uç Insert	Vida Screw	Anahtar Torx Key
KYCR LOGU 030310											
VT LOGU 03 001 KYCR	✓	✓	20	3	36	60	10,5	M10	LOGU 0303	M3X8	T08
VT LOGU 03 002 KYCR	✓	✓	25	4	36	60	12,5	M12			
VT LOGU 03 003 KYCR	✓	✓	32	5	38	62	17	M16			
VT LOGU 03 004 KYCR	✓	✓	40	6	40	65	17	M16			
VT LOGU 03 005 KYCR	✓	✓	42	6	40	65	17	M16			

► BLM. 0603 TT

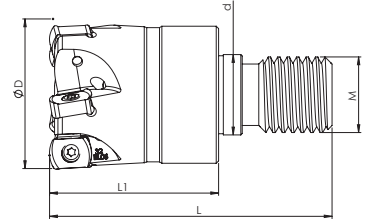

Kesici Uç Uyumluluğu Insert Suitability	Stok Stock	Inter Cooland	D	Z	L1	L	d	M	Uç Insert	Vida Screw	Anahtar Torx Key
TT BLM. 0603											
VT BLM 06 001 TT	✓	✓	32	5	36	60	17	M16	BLM 0603	M2,5X8	T08
VT BLM 06 002 TT	✓	✓	42	6	36	60	17	M16			
VT BLM 06 003 TT	✓	✓	20	3	36	60	12,5	M12			

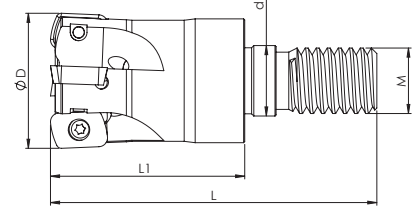
▶ APKW 1003

Kesici Uç Uyumluluğu Insert Suitability	Stok Stock	Inter Cooland	D	Z	L1	L	d	M	Uç Insert	Vida Screw	Anahtar Torx Key
APKW 1003											
VT APKW 10 001 FR	✓	✓	16	2	28	50	8,5	M8	APKW 1003	M2,5X7	T8
VT APKW 10 002 FR	✓	✓	20	3	35	60	10,5	M10			
VT APKW 10 003 FR	✓	✓	25	4	35	60	12,5	M12			

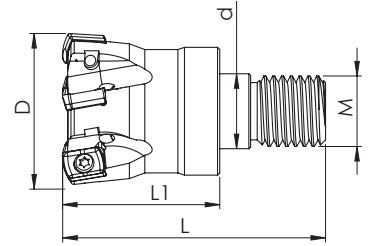
▶ LNMT 0603 KRLY

Kesici Uç Uyumluluğu Insert Suitability	Stok Stock	Inter Cooland	D	Z	L1	L	d	M	Uç Insert	Vida Screw	Anahtar Torx Key
KRLY LNMT 060310											
VT LNMT 06 001 KRLY	✓	✓	25	3	36	60	12,5	M12	LNMT 0603	M3X8	T10
VT LNMT 06 002 KRLY	✓	✓	35	5	36	60	17	M16			
VT LNMT 06 003 KRLY	✓	✓	40	6	36	60	17	M16			

► P26335 R10/R14 WLTR

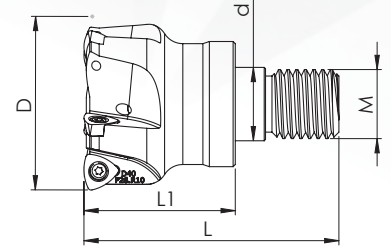

Kesici Uç Uyumluluğu Insert Suitability	Stok Stock	Inter Cooland	D	Z	L1	L	d	M	Uç Insert	Vida Screw	Anahtar Torx Key
WLTR P26335 R10/R14											
VT P2633 R14 002 WLTR	✓	✓	40	5	36	60	17	M16	P26..R-10	M2,5X7	T8
VT P2633 R10 004 WLTR	✓	✓	32	3	36	60	17	M16	P26..R-14	M4X11	T15

► SDKX 0904/1205 LMN

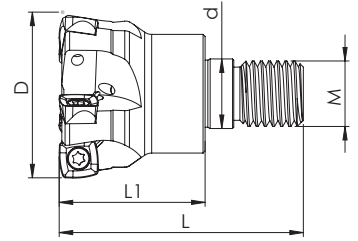

Kesici Uç Uyumluluğu Insert Suitability	Stok Stock	Inter Cooland	D	Z	L1	L	d	M	Uç Insert	Vida Screw	Anahtar Torx Key
LMN SDKX 0904/1205											
VT SDKX 09 001 LMN	✓	✓	35	4	36	60	17	M16	SDKX 0904	M3,5X8	T15
VT SDKX 09 002 LMN	✓	✓	42	5	36	60	17	M16			
VT SDKX 12 003 LMN	✓	✓	32	2	36	60	17	M16	SDKX 1205	M4X11	

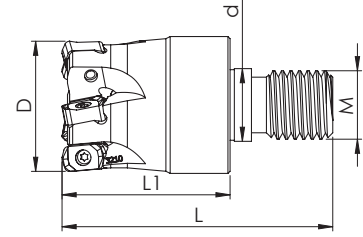
► BNGX 10T3 PRMT

Kesici Uç Uyumluluğu Insert Suitability	Stok Stock	Inter Cooland	D	Z	L1	L	d	M	Uç Insert	Vida Screw	Anahtar Torx Key
PRMT BNGX 10T3											
VT BNGX 10 001 PRMT	✓	✓	25	4	28	50	12,5	M12	BNGX 10T3	M2,5X8	T8
VT BNGX 10 002 PRMT	✓	✓	32	5	38	62	17	M16			

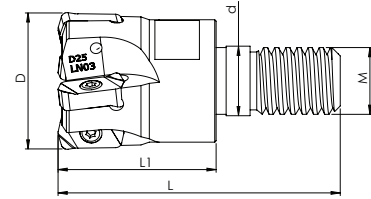



► LNMU 0303 TNGLY

Kesici Uç Uyumluluğu Insert Suitability	Stok Stock	Inter Cooland	D	Z	L1	L	d	M	Uç Insert	Vida Screw	Anahtar Torx Key
TNGLY LNMU 0303											
VT LNMU 03 001 TNG	x	x	25	4	28	50	12,5	M12	LNMU 0303	M2,5X8	T8
VT LNMU 03 002 TNG	✓	✓	32	5	38	62	17	M16			

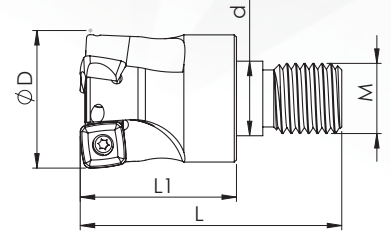

► SDMT 1004 BHLR



Kesici Uç Uyumluluğu Insert Suitability	Stok Stock											
BHLR SDMT 1004		Inter Cooland	D	Z	L1	L	d	M		Uç Insert	Vida Screw	Anahtar Torx Key
VT SDMT 10 001 BHLR	✓	✓	32	3	26	60	17	M16		SDMT 1004	M2,5X7	T8
VT SDMT 10 002 BHLR	✓	✓	25	2	28	50	12,5	M12				



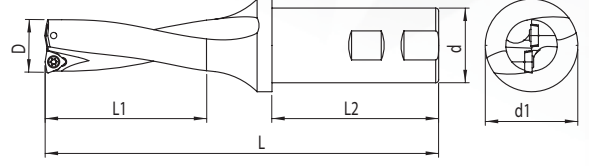

► DRILL WCM. D2

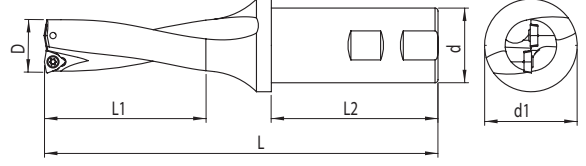

Kesici Uç Uyumluluğu Insert Suitability	Stok Stock	Inter Cooland	D	d	d1	L	L1	L2			
									Uç Insert	Vida Screw	Anahtar Torx Key
WCM D2 016 ISO	✓	✓	16	25	34	110	32	50	WCM 030208	M2,5X5	T08
WCM D2 017 ISO	✓	✓	17	25	34	112	34	56			
WCM D2 018 ISO	✓	✓	18	25	34	114	36	56			
WCM D2 019 ISO	✓	✓	19	25	34	116	38	56	WCM 040208	M2,5X5	T08
WCM D2 020 ISO	✓	✓	20	25	34	119	40	56			
WCM D2 021 ISO	✓	✓	21	25	34	122	42	56			
WCM D2 022 ISO	✓	✓	22	25	34	125	44	56	WCM 050308	M3X9	T10
WCM D2 023 ISO	✓	✓	23	25	34	128	46	56			
WCM D2 024 ISO	✓	✓	24	25	34	129	48	56			
WCM D2 025 ISO	✓	✓	25	25	34	131	50	56	WCM 06T308	M3,5X9	T15
WCM D2 026 ISO	✓	✓	26	25	34	134	52	56			
WCM D2 027 ISO	✓	✓	27	25	34	137	54	56			
WCM D2 028 ISO	✓	✓	28	25	34	140	56	56			
WCM D2 029 ISO	✓	✓	29	25	34	143	58	56			
WCM D2 030 ISO	✓	✓	30	32	44	150	60	60			
WCM D2 031 ISO	✓	✓	31	32	44	153	62	60			
WCM D2 032 ISO	✓	✓	32	32	44	156	64	60			
WCM D2 033 ISO	✓	✓	33	32	44	159	66	60			
WCM D2 034 ISO	✓	✓	34	32	44	162	68	60			
WCM D2 035 ISO	✓	✓	35	32	44	165	70	60			
WCM D2 036 ISO	✓	✓	36	32	44	168	72	60			
WCM D2 037 ISO	✓	✓	37	32	44	171	74	60			
WCM D2 038 ISO	✓	✓	38	32	44	174	76	60			
WCM D2 039 ISO	✓	✓	39	32	44	177	78	60			
WCM D2 040 ISO	✓	✓	40	32	44	180	80	60			
WCM D2 041 ISO	✓	✓	41	32	44	183	82	60			
WCM D2 042 ISO	✓	✓	42	32	44	186	84	60			
WCM D2 043 ISO	✓	✓	43	32	44	189	86	60			
WCM D2 044 ISO	✓	✓	44	32	44	192	88	60			
WCM D2 045 ISO	✓	✓	45	40	54	195	90	70			
WCM D2 046 ISO	✓	✓	46	40	54	198	92	70			
WCM D2 047 ISO	✓	✓	47	40	54	201	94	70			
WCM D2 048 ISO	✓	✓	48	40	54	204	96	70			
WCM D2 049 ISO	✓	✓	49	40	54	207	98	70			
WCM D2 050 ISO	✓	✓	50	40	54	210	100	70	WCM 080412	M4X11	T15

► DRILL WCM. D3



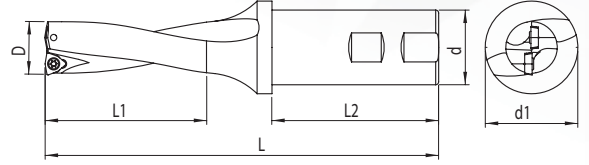

Kesici Uç Uyumluluğu Insert Suitability	Stok Stock	Inter Cooland	D	d	d1	L	L1	L2			
									Uç Insert	Vida Screw	Anahtar Torx Key
WCM.D3 015,5 ISO	✓	✓	15,5	25	34	126	46,5	56	WCM 030208	M2.5X5	T08
WCM.D3 016 ISO	✓	✓	16	25	34	126	48	56			
WCM.D3 016,5 ISO	✓	✓	16,5	25	34	129	49,5	56			
WCM.D3 017 ISO	✓	✓	17	25	34	129	51	56			
WCM.D3 017,5 ISO	✓	✓	17,5	25	34	132	52,5	56			
WCM.D3 018 ISO	✓	✓	18	25	34	132	54	56			
WCM.D3 018,5 ISO	✓	✓	18,5	25	34	135	55,5	56			
WCM.D3 019 ISO	✓	✓	19	25	34	135	57	56			
WCM.D3 019,5 ISO	✓	✓	19,5	25	34	139	58,5	56			
WCM.D3 020 ISO	✓	✓	20	25	34	139	60	56			
WCM.D3 020,5 ISO	✓	✓	20,5	25	34	143	61,5	56	WCM 040208	M2.5X5	T08
WCM.D3 021 ISO	✓	✓	21	25	34	143	63	56			
WCM.D3 021,5 ISO	✓	✓	21,5	25	34	147	64,5	56			
WCM.D3 022 ISO	✓	✓	22	25	34	147	66	56			
WCM.D3 022,5 ISO	✓	✓	22,5	25	34	151	67,5	56			
WCM.D3 023 ISO	✓	✓	23	25	34	151	69	56			
WCM.D3 023,5 ISO	✓	✓	23,5	25	34	153	70,5	56			
WCM.D3 024 ISO	✓	✓	24	25	34	153	72	56	WCM 050308	M3X9	T10
WCM.D3 024,5 ISO	✓	✓	24,5	25	34	156	73,5	56			
WCM.D3 025 ISO	✓	✓	25	25	34	156	75	56			
WCM.D3 025,5 ISO	✓	✓	25,5	25	34	160	76,5	56			
WCM.D3 026 ISO	✓	✓	26	25	34	160	78	56			
WCM.D3 026,5 ISO	✓	✓	26,5	25	34	164	79,5	56			
WCM.D3 027 ISO	✓	✓	27	25	34	164	81	56			
WCM.D3 027,5 ISO	✓	✓	27,5	25	34	168	82,5	56			
WCM.D3 028 ISO	✓	✓	28	25	34	168	84	56			
WCM.D3 028,5 ISO	✓	✓	28,5	25	34	172	85,5	56			
WCM.D3 029 ISO	✓	✓	29	25	34	172	87	56			
WCM.D3 029,5 ISO	✓	✓	29,5	25	34	180	88,5	56			
WCM.D3 030 ISO	✓	✓	30	32	44	180	90	60			
WCM.D3 031 ISO	✓	✓	31	32	44	184	93	60			
WCM.D3 032 ISO	✓	✓	32	32	44	188	96	60			
WCM.D3 033 ISO	✓	✓	33	32	44	192	99	60			
WCM.D3 034 ISO	✓	✓	34	32	44	192	102	60			
WCM.D3 035 ISO	✓	✓	35	32	44	200	105	60			
WCM.D3 036 ISO	✓	✓	36	32	44	204	108	60	WCM 080412	M4X11	T15
WCM.D3 037 ISO	✓	✓	37	32	44	208	111	60			
WCM.D3 038 ISO	✓	✓	38	32	44	212	114	60			
WCM.D3 039 ISO	✓	✓	39	32	44	216	117	60			
WCM.D3 040 ISO	✓	✓	40	32	44	220	120	60			
WCM.D3 041 ISO	✓	✓	41	32	44	223	123	60			
WCM.D3 042 ISO	✓	✓	42	32	44	226	126	60			
WCM.D3 043 ISO	✓	✓	43	32	44	229	129	60			
WCM.D3 044 ISO	✓	✓	44	32	44	232	132	60			
WCM.D3 045 ISO	✓	✓	45	40	54	245	135	70			
WCM.D3 046 ISO	✓	✓	46	40	54	248	138	70			
WCM.D3 047 ISO	✓	✓	47	40	54	251	141	70			
WCM.D3 048 ISO	✓	✓	48	40	54	254	144	70			
WCM.D3 049 ISO	✓	✓	49	40	54	257	147	70			
WCM.D3 050 ISO	✓	✓	50	40	54	260	150	70			

► DRILL WCM. D4

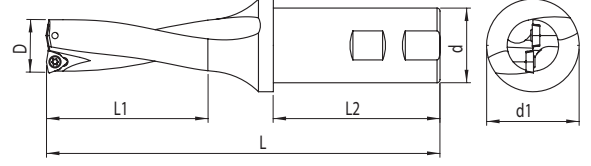

Kesici Uç Uyumluluğu Insert Suitability	Stok Stock	Inter Cooland	D	d	d1	L	L1	L2			
									Uç Insert	Vida Screw	Anahtar Torx Key
WCM.D4 016 ISO	✓	✓	16	25	34	142	64	56	WCM.030208	M2,5X5	T08
WCM.D4 017 ISO	✓	✓	17	25	34	146	68	56			
WCM.D4 017,5 ISO	✓	✓	17,5	25	34	150	72	56			
WCM.D4 018 ISO	✓	✓	18	25	34	150	72	56			
WCM.D4 019 ISO	✓	✓	19	25	34	154	76	56			
WCM.D4 019,5 ISO	✓	✓	19,5	25	34	159	80	56			
WCM.D4 020 ISO	✓	✓	20	25	34	159	80	56	WCM.040208		
WCM.D4 021 ISO	✓	✓	21	25	34	164	84	56			
WCM.D4 022 ISO	✓	✓	22	25	34	169	88	56			
WCM.D4 023 ISO	✓	✓	23	25	34	174	92	56			
WCM.D4 024 ISO	✓	✓	24	25	34	177	96	56	WCM.050308	M3X9	T10
WCM.D4 025 ISO	✓	✓	25	25	34	181	100	56			
WCM.D4 026 ISO	✓	✓	26	25	34	186	104	56			
WCM.D4 027 ISO	✓	✓	27	25	34	191	108	56			
WCM.D4 028 ISO	✓	✓	28	25	34	196	112	56			
WCM.D4 029 ISO	✓	✓	29	25	34	201	116	56			
WCM.D4 030 ISO	✓	✓	30	32	44	210	120	60	WCM.06T308	M3,5X9	T15
WCM.D4 031 ISO	✓	✓	31	32	44	215	124	60			
WCM.D4 032 ISO	✓	✓	32	32	44	220	128	60			
WCM.D4 033 ISO	✓	✓	33	32	44	225	132	60			
WCM.D4 034 ISO	✓	✓	34	32	44	230	136	60			
WCM.D4 035 ISO	✓	✓	35	32	44	235	140	60			
WCM.D4 036 ISO	✓	✓	36	32	44	238	144	60			
WCM.D4 037 ISO	✓	✓	37	32	44	241	148	60			
WCM.D4 038 ISO	✓	✓	38	32	44	244	152	60			
WCM.D4 039 ISO	✓	✓	39	32	44	247	166	60			
WCM.D4 040 ISO	✓	✓	40	32	44	250	160	60			
WCM.D4 041 ISO	✓	✓	41	32	44	253	164	60			
WCM.D4 042 ISO	✓	✓	42	32	44	256	168	60			
WCM.D4 043 ISO	✓	✓	43	32	44	259	172	60			
WCM.D4 044 ISO	✓	✓	44	32	44	262	176	60			

► DRILL WCM. D5



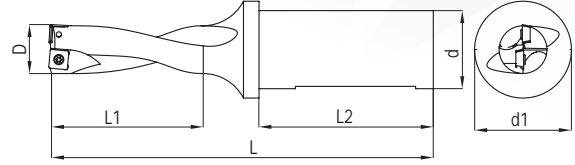

Kesici Uç Uyumluluğu Insert Suitability	Stok Stock	Inter Cooland	D	d	d1	L	L1	L2			
									Uç Insert	Vida Screw	Anahtar Torx Key
WCM											
WCM.D5 016 ISO	✓	✓	16	25	34	153	80	56	WCM.030208	M2,5X5	T08
WCM.D5 017 ISO	✓	✓	17	25	34	158	85	56			
WCM.D5 018 ISO	✓	✓	18	25	34	163	90	56			
WCM.D5 019 ISO	✓	✓	19	25	34	168	95	56			
WCM.D5 020 ISO	✓	✓	20	25	34	174	100	56			
WCM.D5 021 ISO	✓	✓	21	25	34	180	105	56			
WCM.D5 022 ISO	✓	✓	22	25	34	186	110	56	WCM.040208	M3X9	T10
WCM.D5 023 ISO	✓	✓	23	25	34	192	115	56			
WCM.D5 024 ISO	✓	✓	24	25	34	196	120	56			
WCM.D5 025 ISO	✓	✓	25	25	34	200	125	56	WCM.050308	M3,5X9	T15
WCM.D5 026 ISO	✓	✓	26	25	34	206	130	56			
WCM.D5 027 ISO	✓	✓	27	25	34	212	135	56			
WCM.D5 028 ISO	✓	✓	28	25	34	218	140	56			
WCM.D5 029 ISO	✓	✓	29	25	34	224	145	56			
WCM.D5 030 ISO	✓	✓	30	32	44	233	150	60			

► DRILL SP.. D2

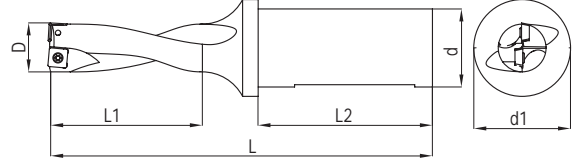

Kesici Uç Uyumluluğu Insert Suitability	Stok Stock	Inter Cooland	D	d	d1	L	L1	L2	Uç Insert	Vida Screw	Anahtar Torx Key
TGTC / PLBT / ZCC / KLP											
SP..D2 013 ISO	✓	✓	13	20	25	94	26	50	SP..050204	M2X5	T06
SP..D2 014 ISO	✓	✓	14	20	25	97	28	50			
SP..D2 015 ISO	✓	✓	15	20	25	100	30	50	SP..060204	M2.2X5	
SP..D2 016 ISO	✓	✓	16	25	34	110	32	50			
SP..D2 017 ISO	✓	✓	17	25	34	112	34	56	SP..07T308	M2.5X7	
SP..D2 018 ISO	✓	✓	18	25	34	114	36	56			
SP..D2 019 ISO	✓	✓	19	25	34	116	38	56			
SP..D2 019,5 ISO	✓	✓	19,5	25	34	119	40	56			
SP..D2 020 ISO	✓	✓	20	25	34	119	40	56			
SP..D2 20,5 ISO	✓	✓	20,5	25	34	122	42	56			
SP..D2 021 ISO	✓	✓	21	25	34	122	42	56			
SP..D2 022 ISO	✓	✓	22	25	34	125	44	56			
SP..D2 023 ISO	✓	✓	23	25	34	128	46	56			
SP..D2 024 ISO	✓	✓	24	25	34	129	48	56			SP..090408
SP..D2 025 ISO	✓	✓	25	25	34	131	50	56			
SP..D2 026 ISO	✓	✓	26	25	34	134	52	56			
SP..D2 027 ISO	✓	✓	27	25	34	137	54	56			
SP..D2 027,5 ISO	✓	✓	27,5	25	34	140	56	56			
SP..D2 028 ISO	✓	✓	28	25	34	140	56	56			
SP..D2 029 ISO	✓	✓	29	25	34	143	58	56			
SP..D2 030 ISO	✓	✓	30	32	44	150	60	60			
SP..D2 031 ISO	✓	✓	31	32	44	153	62	60			
SP..D2 032 ISO	✓	✓	32	32	44	156	64	60	SP..110408	M4X11	
SP..D2 033 ISO	✓	✓	33	32	44	159	66	60			
SP..D2 034 ISO	✓	✓	34	32	44	162	68	60			
SP..D2 035 ISO	✓	✓	35	32	44	165	70	60			
SP..D2 036 ISO	✓	✓	36	32	44	168	72	60			
SP..D2 037 ISO	✓	✓	37	32	44	171	74	60			
SP..D2 038 ISO	✓	✓	38	32	44	174	76	60			
SP..D2 039 ISO	✓	✓	39	32	44	177	78	60			
SP..D2 040 ISO	✓	✓	40	32	44	180	80	60			
SP..D2 041 ISO	✓	✓	41	32	44	183	82	60			SP..140512
SP..D2 042 ISO	✓	✓	42	32	44	186	84	60			
SP..D2 42,5 ISO	✓	✓	42,5	32	44	189	86	60			
SP..D2 043 ISO	✓	✓	43	32	44	189	86	60			
SP..D2 044 ISO	✓	✓	44	32	44	192	88	60			
SP..D2 045 ISO	✓	✓	45	40	54	195	90	70			
SP..D2 046 ISO	✓	✓	46	40	54	198	92	70			
SP..D2 047 ISO	✓	✓	47	40	54	201	94	70			
SP..D2 048 ISO	✓	✓	48	40	54	204	96	70			
SP..D2 049 ISO	✓	✓	49	40	54	207	98	70			
SP..D2 050 ISO	✓	✓	50	40	54	210	100	70			

► DRILL SP.. D3



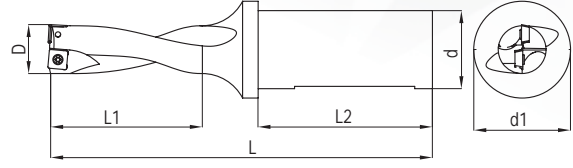

Kesici Uç Uyumluluğu Insert Suitability	Stok Stock	Inter Cooland	D	d	d1	L	L1	L2						
									Uç Insert	Vida Screw	Anahtar Torx Key			
TGTC / PLBT / ZCC / KLP														
SP..D3 013 ISO	✓	✓	13	20	25	101	39	50	SP..050204	M2X5	T06			
SP..D3 014 ISO	✓	✓	14	20	25	105	42	50						
SP..D3 014,5 ISO	✓	✓	14,5	20	25	109	45	50						
SP..D3 015 ISO	✓	✓	15	20	25	109	45	50						
SP..D3 015,5 ISO	✓	✓	15,5	20	34	126	48	50						
SP..D3 016 ISO	✓	✓	16	20	34	126	48	50						
SP..D3 016,5 ISO	✓	✓	16,5	25	34	129	51	50	SP..060204	M2.2X5	T06			
SP..D3 017 ISO	✓	✓	17	25	34	129	51	56						
SP..D3 017,5 ISO	✓	✓	17,5	25	34	132	54	56						
SP..D3 018 ISO	✓	✓	18	25	34	132	54	56						
SP..D3 018,5 ISO	✓	✓	18,5	25	34	135	57	56						
SP..D3 019 ISO	✓	✓	19	25	34	135	57	56						
SP..D3 019,5 ISO	✓	✓	19,5	25	34	139	60	56						
SP..D3 020 ISO	✓	✓	20	25	34	139	60	56						
SP..D3 020,5 ISO	✓	✓	20,5	25	34	143	63	56						
SP..D3 021 ISO	✓	✓	21	25	34	143	63	56						
SP..D3 021,5 ISO	✓	✓	21,5	25	34	147	66	56	SP..07T308	M2.5X7	T08			
SP..D3 022 ISO	✓	✓	22	25	34	147	66	56						
SP..D3 022,5 ISO	✓	✓	22,5	25	34	151	69	56						
SP..D3 023 ISO	✓	✓	23	25	34	151	69	56						
SP..D3 023,5 ISO	✓	✓	23,5	25	34	153	72	56						
SP..D3 024 ISO	✓	✓	24	25	34	153	72	56						
SP..D3 024,5 ISO	✓	✓	24,5	25	34	156	75	56						
SP..D3 025 ISO	✓	✓	25	25	34	156	75	56						
SP..D3 025,5 ISO	✓	✓	25,5	25	34	160	78	56						
SP..D3 026 ISO	✓	✓	26	25	34	160	78	56						
SP..D3 026,5 ISO	✓	✓	26,5	25	34	164	81	56						
SP..D3 027 ISO	✓	✓	27	25	34	164	81	56						
SP..D3 027,5 ISO	✓	✓	27,5	25	34	168	84	56						
SP..D3 028 ISO	✓	✓	28	25	34	168	84	56				SP..090408	M3,5X8	T15
SP..D3 028,5 ISO	✓	✓	28,5	25	34	172	87	56						
SP..D3 029 ISO	✓	✓	29	25	34	172	87	56						
SP..D3 029,5 ISO	✓	✓	29,5	25	44	180	90	56						
SP..D3 030 ISO	✓	✓	30	32	44	180	90	60						
SP..D3 031 ISO	✓	✓	31	32	44	184	93	60						
SP..D3 032 ISO	✓	✓	32	32	44	188	96	60						
SP..D3 033 ISO	✓	✓	33	32	44	192	99	60						
SP..D3 034 ISO	✓	✓	34	32	44	192	102	60						
SP..D3 035 ISO	✓	✓	35	32	44	200	105	60	SP..110408	M4X11	T15			
SP..D3 036 ISO	✓	✓	36	32	44	204	108	60						
SP..D3 037 ISO	✓	✓	37	32	44	208	111	60						
SP..D3 038 ISO	✓	✓	38	32	44	212	114	60						
SP..D3 039 ISO	✓	✓	39	32	44	216	117	60						
SP..D3 040 ISO	✓	✓	40	32	44	220	120	60						
SP..D3 041 ISO	✓	✓	41	32	44	223	123	60						
SP..D3 042 ISO	✓	✓	42	32	44	226	126	60						
SP..D3 043 ISO	✓	✓	43	32	44	229	129	60				SP..140512	M5X11	T20
SP..D3 044 ISO	✓	✓	44	32	44	232	132	60						
SP..D3 045 ISO	✓	✓	45	40	54	245	135	70						
SP..D3 046 ISO	✓	✓	46	40	54	248	138	70						
SP..D3 047 ISO	✓	✓	47	40	54	251	141	70						
SP..D3 048 ISO	✓	✓	48	40	54	254	144	70						
SP..D3 049 ISO	✓	✓	49	40	54	257	147	70						
SP..D3 050 ISO	✓	✓	50	40	54	260	150	70						

► DRILL SP.. D4

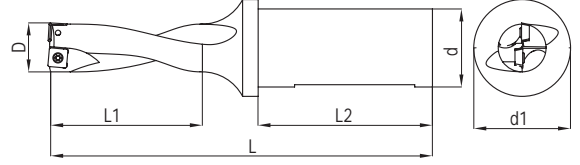

Kesici Uç Uyumluluğu Insert Suitability	Stok Stock	Inter Cooland	D	d	d1	L	L1	L2				
									Uç Insert	Vida Screw	Anahtar Torx Key	
TGTC / PLBT / ZCC / KLP												
SP..D4 013 ISO	✓	✓	13	20	25	120	52	50	SP..050204	M2X5	T06	
SP..D4 014 ISO	✓	✓	14	20	25	124	56	50				
SP..D4 014,5 ISO	✓	✓	14,5	20	25	128	60	50				
SP..D4 015 ISO	✓	✓	15	20	25	128	60	50	SP..060204	M2.2X5		
SP..D4 016 ISO	✓	✓	16	25	34	142	64	50				
SP..D4 017 ISO	✓	✓	17	25	34	146	68	56				
SP..D4 018 ISO	✓	✓	18	25	34	150	72	56	SP..070204	M2.5X7		
SP..D4 019 ISO	✓	✓	19	25	34	154	76	56				
SP..D4 019,5 ISO	✓	✓	19,5	25	34	159	80	56				
SP..D4 020 ISO	✓	✓	20	25	34	159	80	56	SP..07T308	M2.5X7		
SP..D4 021 ISO	✓	✓	21	25	34	164	84	56				
SP..D4 022 ISO	✓	✓	22	25	34	169	88	56				
SP..D4 023 ISO	✓	✓	23	25	34	174	92	56	SP..090408	M3,5X8		
SP..D4 024 ISO	✓	✓	24	25	34	177	96	56				
SP..D4 024,5 ISO	✓	✓	23,5	25	34	181	100	56				
SP..D4 025 ISO	✓	✓	25	25	34	181	100	56	SP..110408	M4X11		
SP..D4 026 ISO	✓	✓	26	25	34	186	104	56				
SP..D4 027 ISO	✓	✓	27	25	34	191	108	56				
SP..D4 027,5 ISO	✓	✓	27,5	25	34	196	112	56	SP..110408	M4X11		
SP..D4 028 ISO	✓	✓	28	25	34	196	112	56				
SP..D4 029 ISO	✓	✓	29	25	34	201	116	56				
SP..D4 030 ISO	✓	✓	30	32	44	210	120	60	SP..110408	M4X11		
SP..D4 031 ISO	✓	✓	31	32	44	215	124	60				
SP..D4 032 ISO	✓	✓	32	32	44	220	128	60				
SP..D4 033 ISO	✓	✓	33	32	44	225	132	60	SP..110408	M4X11		
SP..D4 033,5 ISO	✓	✓	33,5	32	44	230	136	60				
SP..D4 034 ISO	✓	✓	34	32	44	230	136	60				
SP..D4 035 ISO	✓	✓	35	32	44	235	140	60	SP..110408	M4X11		
SP..D4 036 ISO	✓	✓	36	32	44	238	144	60				
SP..D4 037 ISO	✓	✓	37	32	44	241	148	60				
SP..D4 038 ISO	✓	✓	38	32	44	244	152	60	SP..110408	M4X11		
SP..D4 038,5 ISO	✓	✓	38,5	32	44	247	156	60				
SP..D4 039 ISO	✓	✓	39	32	44	247	156	60				
SP..D4 040 ISO	✓	✓	40	32	44	250	160	60	SP..110408	M4X11		
SP..D4 041 ISO	✓	✓	41	32	44	253	164	60				

► DRILL SP.. D5

Kesici Uç Uyumluluğu Insert Suitability	Stok Stock	Inter Cooland	D	d	d1	L	L1	L2			
									Uç Insert	Vida Screw	Anahtar Torx Key
TGTC / PLBT / ZCC / KLP											
SP..D5 013 ISO	X	✓	13	20	25	120	65	50	SP..050204	M2X5	T06
SP..D5 014 ISO	X	✓	14	20	25	124	70	50			
SP..D5 015 ISO	X	✓	15	20	25	128	75	50			
SP..D5 016 ISO	✓	✓	16	25	34	153	80	50	SP..060204	M2.2X5	
SP..D5 017 ISO	✓	✓	17	25	34	158	85	56			
SP..D5 018 ISO	✓	✓	18	25	34	163	90	56			
SP..D5 019 ISO	✓	✓	19	25	34	168	95	56			
SP..D5 020 ISO	✓	✓	20	25	34	174	100	56	SP..070204		
SP..D5 021 ISO	✓	✓	21	25	34	180	105	56			
SP..D5 022 ISO	✓	✓	22	25	34	186	110	56	SP..07T308	M2.5X7	
SP..D5 023 ISO	✓	✓	23	25	34	192	115	56			
SP..D5 024 ISO	✓	✓	24	25	34	196	120	56			
SP..D5 025 ISO	✓	✓	25	25	34	200	125	56	SP..090408	M3,5X8	T15
SP..D5 026 ISO	✓	✓	26	25	34	206	130	56			
SP..D5 027 ISO	✓	✓	27	25	34	212	135	56			
SP..D5 028 ISO	✓	✓	28	25	34	218	140	56			
SP..D5 029 ISO	✓	✓	29	25	34	224	145	56			
SP..D5 030 ISO	✓	✓	30	32	44	233	150	60			

► PASO KATERLERİ - STEP CUTTING TOOLS

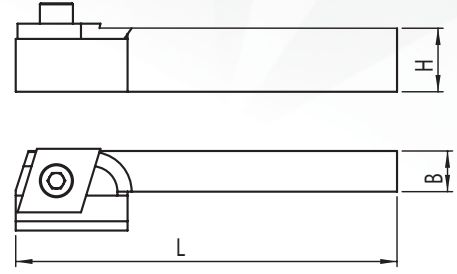

	Stok Stock	H	B	L1	L2	Vida Screw	Anahtar Allen Key
HSS PS 001 ISO	✓	25	17	45	150	M8X25	A6
HSS PS 002 ISO	✓	25	17	45	150		
HSS PS 003 ISO	✓	25	17	45	150		
HSS PS 004 ISO	✓	25	17	45	150		

► KESME KATERLERİ - CUTTING TOOLS

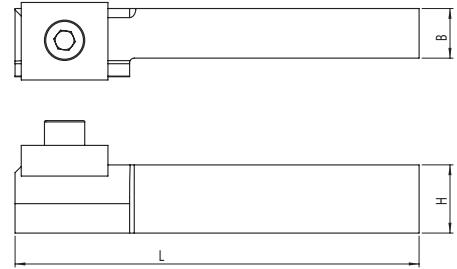

	Stok Stock	H	B	L1	L2	Vida Screw	Anahtar Allen Key
HSS KS 001 ISO	✓	25	17	45	150	M8X25	A6
HSS KS 002 ISO	✓	22	16	37	150		
HSS KS 003 ISO	✓	25	17	45	150		
HSS KS 004 ISO	✓	25	17	46	150		
HSS KS 005 ISO	✓	25	17	45	150		

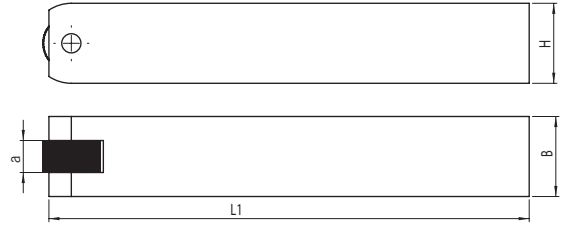
TIRTIR TEKLİ - SINGLE TOOLS

	Stok Stock	B	H	a	L	Pim Pin	
TIR TIR 005	✓	16	16	6	125	4x16	
TIR TIR 006	✓	16	16	8	125	6x16	
TIR TIR 007	✓	20	20	8	125	6x20	
TIR TIR 008	✓	20	20	10	125	6x20	
TIR TIR 009	✓	25	25	8	150	6x25	
TIR TIR 010	✓	25	25	10	150	6x25	
TIR TIR 012	✓	16	16	10	125	6X16	
TIR TIR 013	✓	20	20	10	125	6X20	R45
TIR TIR 015	✓	16	16	6	125	4x16	
TIR TIR 016	✓	16	16	6	125	6x16	
TIR TIR 017	✓	16	16	8	125	6x16	
TIR TIR 018	✓	16	16	10	125	6x16	
TIR TIR 019	✓	25	25	10	150	6X25	R45
TIR TIR 020	✓	20	20	10	125	6X20	R45

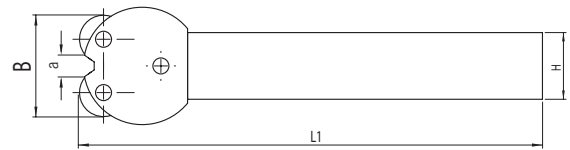
TIRTIR ÇİFTLİ - DOUBLE TOOLS

	Stok Stock	B	H	a	L	Pim Pin
TIR TIR Ç 001	✓	22	22	10	150	6x25

► STANDART YUMUŞAK AYAK - STANDARD

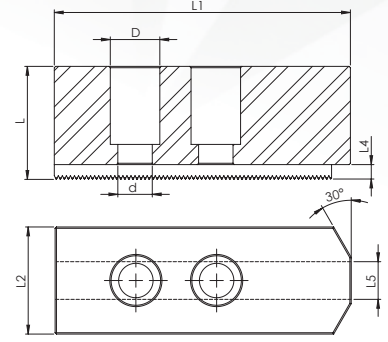

KOD	Stok Stock	Inter Cooland	D	d	L	L1	L2	L4	L5
SYA 8" 001	✓	×	18,5	12,8	37	95	35	5,5	14,15
SYA 10" 002	✓	×	18,5	12,8	42	110	39,75	5,5	16,15

► YÜKSEK YUMUŞAK AYAK - HIGH

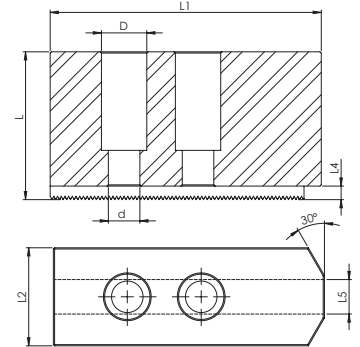

KOD	Stok Stock	Inter Cooland	D	d	L	L1	L2	L4	L5
YYA 8" 001	✓	×	18,5	12,8	67	95	35	5,5	14,15
YYA 10" 002	✓	×	18,5	12,8	77	110	39,8	5,5	16,15

► CİVATALAR - SCREWS

BASKI CİVATALARI

M5X23 A3
M6X27 A3

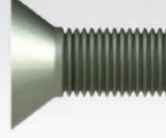

ALTLIK VİDALARI

M3X10
M4X10
M5X10



BUKSE VİDA

M5X0.5X3.5
M6X0.5X4



TORX VİDALAR

M2X4
M2X5
M2X6
M2.2X5
M2.2X6
M2.5X5
M2.5X6
M2.5X7
M2.5X8
M2.5X10
M3X6
M3X7
M3X8
M3X10
M3.5X8
M3.5X9
M3.5X10
M3.5X11
M3.5X14
M4X11
M4X12
M4.5X12
M4.5X16
M5X12

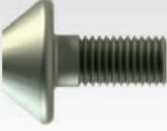

BASKI VİDASI

M6X0.75 TPKN 16



BASKI VİDASI

M8X1 TPKN 22

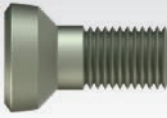

KESME KATER VİDASI

M6X27 A4

► KÜRE TAKIM VİDALARI - BALL NOSE SCREWS



KÜRE TAKIM VİDALARI

M3X7 D8
M4X9 D10
M5X10 D12
M5X12 D16
M5X16 D20
M6X22 D25
M8X25 D30

► ALTLIKLAR - SHIMS

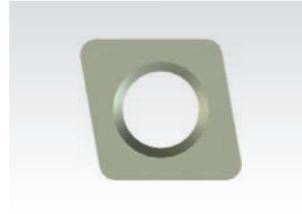

ALTLIK
DNMG 15
DNMG 11



ALTLIK
CNMG 12
CNMG 16
CNMG 19



ALTLIK
TNMG 16
TNMG 22

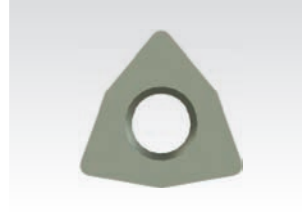

ALTLIK
WNMG 08



ALTLIK
DCMT 11



ALTLIK
VBMT 16
VCMT 16

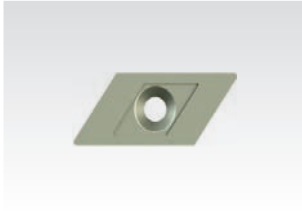

ALTLIK
KNUX 16 SAĞ

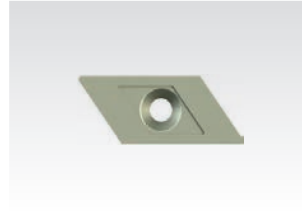

ALTLIK
KNUX 16 SOL



ALTLIK
SIR/SER 16
SIR/SER 22

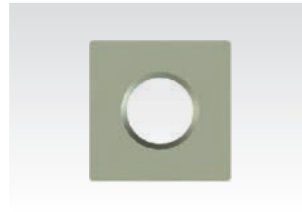

ALTLIK
SNMG 12
SNMG 15
SNMG 19





ALTLIK
CCMT 12

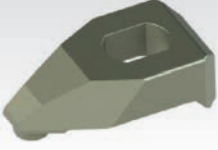
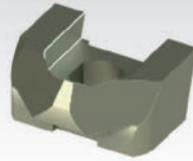
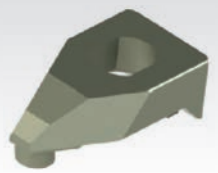
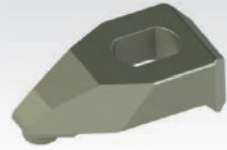
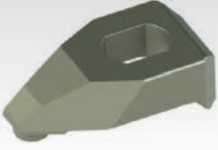
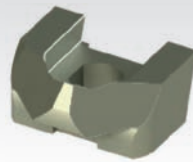
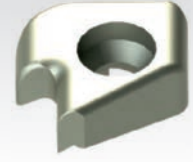
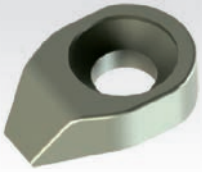
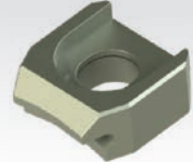

ALTLIK
TCMT 16

► BASKI KEPLERİ - CLAMPS

	BASKI PABUCU T190105 CNMG 19 T190105 SNMG 19		BASKI PABUCU M220105 TNMG 22
	BASKI PABUCU T110105 DNMG 11 T160105 TNMG 16 T060105 WNMG 06		BASKI PABUCU T120105 SNMG 12 T120105 CNMG 12 T150105 DNMG 15 T220105 TNMG 22 T060105 WNMG 08
	BASKI PABUCU T160105 CNMG 16 T160105 SNMG 16		BASKI PABUCU M160105 TNMG 16
	BASKI PABUCU M060105 WNMG 06		BASKI PABUCU C160105 KNUX 16 SAĞ C160105 KNUX 16 SOL C160105 KNUX 16 SOL VE SAĞ
	BASKI PABUCU C110105 TPKN 11 C110105 SNHX 12 C110105 SER/SEL 16 C110105 SER/SEL 22		BASKI PABUCU C160105 TPKN 16
	M SİSTEM ALTLIK PİMİ 5X3.6X15 TNMG 16 5X3.6X15 WNMG 06		BASKI PABUCU M080105 WNMG 08
	BASKI PABUÇ YAYI		BASKI PABUÇ VİDASI PULU 10X6X1 MM
	M SİSTEM ALTLIK PİMİ 6X5X18 TNMG 22 6X5X18 WNMG 08		

► TORNALAMA İÇİN FORMÜLLER

$$\text{DEVİR SAYISI} = n = \frac{V_c \times 1000}{\pi \times D} \quad \text{devir / dakika}$$

Revolutions / Umdrehungen Revs / min.
Umdrehungen / min.

n: Devir Sayısı (dev./dak)
Revolutions / Umdrehungen Revs/min.
Umdrehungen/min.

V_c: Kesme Hızı (m./dak.)
Cutting Speed / Schnittgeschwindigkeit (Meter / Min)

$$\text{KESME HIZI} = V_c = \frac{\pi \times D \times n}{1000} \quad \text{metre / dakika}$$

Cutting speed meter / min.
Schnittgeschwindigkeit

D: İş Parçasının Çapı (mm)
Workpiece diameter / Werkstückdurchmesser

π: Sabit Sayı(3,14)
Constant (3,14) / Gleich bleibend (3,14)

► TORNALAMADA İŞLEME ZAMANININ HESAPLANMASI

$$\text{Çap Tornalamada} = th = \frac{L \times Ps}{n \times f} \quad \text{dakika}$$

Ürning diameter / Drehdurchmesser min.

Ps: Paso Sayısı (kaç defa'da)
no of passes / Durchgänge

th: İşleme Zamanı (dakika)
Processing Time / Bearbeitungszeit (min)

f: İlerleme (mm)
Length delivery / Stirn Zustellung (min.)

$$\text{Alın Tornalama} = th = \frac{dx \pi \times L \times Ps}{V_c \times 1000 \times f} \quad \text{dakika}$$

Length turning / Stirn Drehen min.

Alın Tornalama için Boy
Length head turning / Länge für Stirn Drehen

$$L = \frac{d_1 - d_2}{2} \quad \text{mm}$$

Dolu Malzemede Alın Tornalama
Solid Stock front turning / Massive Werkstücke Stirn Drehen

$$L = \frac{d}{2} \quad \text{mm}$$

► YÜZEY FREZELEMEDE KULLANILAN FORMÜLLER

$$\text{DEVİR SAYISI} = n = \frac{V_c \times 1000}{\pi \times D} \quad \text{devir / dakika}$$

Revolutions / Umdrehungen Revs / min.
Umdrehungen / min.

z: Frezenin Ağız Sayısı (adet)
Number of tooth / Anzahl Schneiden

k: Disk Frezenin Etketif Ağız sayısı (adet)
Effective edge of the cutter / Effektive Schneiden des Fräasers

$$\text{KESME HIZI} = V_c = \frac{\pi \times D \times n}{1000} \quad \text{metre / dakika}$$

Revolutions / Umdrehungen meter / min.
Schnittgeschwindigkeit

f_z: Ağız başına ilerleme (mm/ağız)
Delivery per cutting mm / Z / Zustellung pro Schneide mm/Z

th: İşleme Zamanı (dak.)
Processing time / Bearbeitungszeit minute

$$\text{TABLA İLERLEMESİ} = Vf = n \times z \times f_z \quad \text{mm/ dak}$$

Delivery / Zustellung mm / min.

Ps : Paso Sayısı
Number of passes / Anzahl der Durchgänge



www.baydarlar.com

Organize Sanayi Bölgesi 40. Sk. No:19 BURDUR

Tel : +90.248.252 81 15 - 252 81 65

Faks : +90.248.252 99 37

info@baydarlar.com / info@mbckesicitakim.com