

Ürün Kataloğu

Production Catalog

www.vorgen.com



 **VORGEN®**

The red power for
the professionals
Profesyoneller için
Kırmızı Güç



UNO 20140
MICROSET

VORGEN

VORGEN

VORGEN

VORGEN

VORGEN

VORGEN

VORGEN

VORGEN

VORGEN

VORGEN

VORGEN



The **red** power for
the professionals
Profesyoneller için
Kırmızı Güç



The **red power** for
the professionals.

Profesyoneller için Kırmızı Güç





HAKKIMIZDA / ABOUT

1975 yılında Talaşlı imalat faaliyetiyle sektöre adım atan BAHÇIVAN makine , 1988 yılında sektörde oluşan torna kateri talebi karşısında emek ve yatırımlarını bu doğrultuda kanallize ederek Kesici Uç Bağlama Sistemleri üretimine başlamış. 1996 yılında piyasada oluşan yeni talepleri karşılamak, ürün hassasiyetini en üst düzeye çıkarmak, geriye- ileriye bütünlükle üretim yapmak amacıyla son teknoloji CNC tezgahlarını makine parkuruna dahil etmiştir.

35 yıla yakın zamanı geride bırakan Bahçivan Makine 1000 m² ye yakın kapalı alanı, otomasyon destekli cnc makineleri, kalifeye ekibi ile Talaşlı İmalat sektöründe kullanılan kesici uç bağlama sistemleri üreten lider firmalar arasında yüzde 100 yerli üretimle üreterek ülke ekonomisine ve sanayisine katkıda bulunmakta, Sürekli öğrenen ve gelişen organizasyon yapısı ile üretimde sürekli iyileştirmeyi hedef almakta, Yönetim ve Üretimini ISO 9001:2000 kalite yönetim sistemiyle güçlendirip yurt içi ve yurt dışı pazarında önemli rol üstlenmektedir.

Ve bugün, Bahçivan Makine bu anlayışla, müşteri ve tedarikçilerinden gelen feedback leri değerlendirerek ürün çeşitliliği ve toplam kalite anlayışıyla öncü konuma gelmenin, yurt içi ve yurt dışı pazarlarda aranılan marka haline gelmenin haklı gururunu siz değerli müşterilerimizle ve tedarikçilerimizle paylaşmaktayız.

BAHCIVAN Makine stepped into the sector with Talasli manufacturing in 1975. It transterred its labour and investments to meet lattle tool demand in 1988 and started the manufacturing of cutting edge tie down systems. It incorporated CNC counters With latest technology into its machinery in 1996 to meet incoming demands of market, to raise the product sensitivty to the top level and to realize integrated production backwards and froward.

Bahcivan Makine has a history of more than 35 years. It has a closed area of 1000m², automation assisted CNC machinery and a qualified team. It has been contributing to the conomy and industry of the country with a 100% domestic production among prominent companies of cutting adge tie down system utilized in Talasli manufacturing system.

Bahcivan Makine aims constand improvement in production with its constantly learning and developing organization structure. Its shoulders an important role in internal and external markets by strengthening its management and production through ISO 9001 :2000 quality management system. Today through this point io view and feedbacks of customers and suppliers and with its production varieth and total quality approach, Bahcivan Makina shares the rightful honour with its honorable customers and suppliers, of being a Pioneer in its sector and a desired brand in internal and external markets.

SERTİFİKALAR / CERTIFICATES



İÇİNDEKİLER CONTENTS



**D SİSTEM DIŞ TORNA
KATERLERİ** 10
D SYSTEM EXTERNAL
LATHE TOOL HOLDERS 18



**M SİSTEM DIŞ TORNA
KATERLERİ** 20
M SYSTEM EXTERNAL
LATHE TOOL HOLDERS 21



**C SİSTEM DIŞ TORNA
KATERLERİ** 23
C SYSTEM EXTERNAL
LATHE TOOL HOLDERS 25



**S SİSTEM DIŞ TORNA
KATERLERİ** 28
S SYSTEM EXTERNAL
LATHE TOOL HOLDERS 37



**P SİSTEM DIŞ TORNA
KATERLERİ** 38
P SYSTEM EXTERNAL
LATHE TOOL HOLDERS 39



**TIRTIR DIŞ
TORNA KATERLERİ** 40
INCHINEMUON CLAMP
OUTSIDE DIAMETER 41



**D SİSTEM DELİK
TORNA KATERLERİ** 44
D SYSTEM
BORING BARS 48



**M SİSTEM DELİK
TORNA KATERLERİ** 50
M SYSTEM
BORING BARS 52



**C SİSTEM DELİK
TORNA KATERLERİ** 53
C SYSTEM
BORING BARS 54



**S SİSTEM DELİK
TORNA KATERLERİ** 56
S SYSTEM
BORING BARS 64



VİDA TAKIMLARI 66
SCREW PLUGS 67



**DIŞ ÇAP KANAL AÇMA
TAKIMLARI** 70
EXTERNAL GROOVING
TOOLHOLDERS 83



**DIŞ ÇAP ALIN KANAL
AÇMA TAKIMLARI** 85
FACE EXTERNAL
GROOVING TOOLHOLDERS 86



**DELİK İÇİ KANAL
TAKIMLARI** 87
INTERNAL GROOVING
TOOLHOLDERS 90



PAH FREZELER 91
CHAMFERING END MILLS 92



FREZE TAKIMLARI 94
MILLING TOOLS 121



**PARMAK FREZE
TAKIMLARI** 124
END MILLING
TOOLHOLDERS 137



**DEĞİŞTİRİLEBİLİR UÇLU
MODÜLER FREZELER** 138
MODULAR END MILLS WITH
CHANGEABLE INSERT 140



**DELİK DELME VE
TORNALAMA** 142
HOLE DRILLAND LATHE 157



DİSK FREZE - T FREZE 158
DISK END T MILLING 159



ISO TAKIMLARI 160
ISO TOOLS













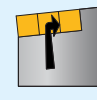

YEDEK PARÇALAR 162
SPARE PARTS 168







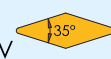

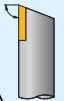
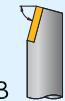
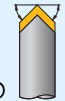

External Turning Code Key

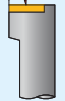
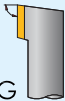

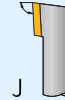

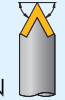

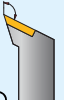
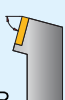
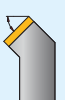
Extract from ISO

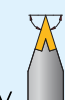
D	W	L	N	R	25	25	M	08
1	2	3	4	5	6	7	8	9

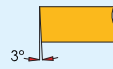
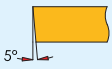
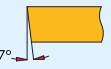
1 Clamping System				
Top Clamping  C	Top and hole clamping  D	Wedge clamping  M	Lever Clamping  P	Screw Clamping  S

2 Insert Shape		
C 	E 	D 
K 	R 	S 
T 	V 	W 

3 Approach Angle					
A 90° 	B 75° 	D 45° 	E 60° 	F 90° 	G 90° 
H 107,5° 	J 93° 	K 75° 	L 95° 	N 63° 	P 117,5° 
Q 107,5° 	R 75° 	S 45° 	T 60° 	U 93° 	V 72,5° 



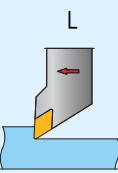
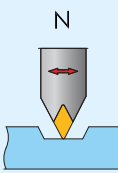
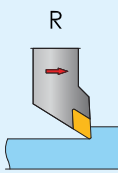



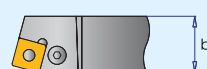

4 Insert Clearance Angle		
A 3° 	B 5° 	C 7° 
D 15° 	E 20° 	F 25° 
G 30° 	N 0° 	P 11° 

5 Hand of Tool		
L 	N 	R 

6 Shank Height h mm

8 = 08 mm 16 = 16 mm 25 = 25 mm

7 Shank Width b mm

8 = 08 mm 16 = 16 mm 25 = 25 mm

8 Tool Length L mm				
				
A = 32	F = 80	M = 150	R = 200	V = 400
B = 40	H = 100	N = 160	S = 250	W = 450
C = 50	K = 125	P = 170	T = 300	Y = 500
D = 60	L = 140	Q = 180	U = 350	X = Special

9 Cutting edge length mm		
C 	E 	D 
K 	R 	S 
T 	V 	W 



The red power for
the professionals
Profesyoneller için
Kırmızı Güç



D SİSTEM DIŞ
TORNA KATERLERİ
D System external lathe tool holders

www.vorgen.com

DDJNR ÜRÜN / PRODUCT 93°

TEKNİK ÇİZİM / TECHNICAL DRAWING

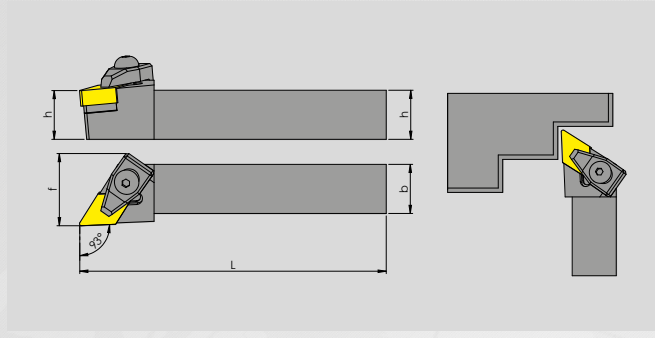

TAKIM KODU ORDERING CODE			KATER ÖLÇÜLERİ DIMENSIONS (mm)				KESİCİ UÇ INSERT	YEDEK PARÇALAR / SPARE PARTS					
			h	b	L	f		BASKI PARÇASI WEDGE CLAMP	BASKI VIDASI SCREW	ALTLIK SHIM	ALTLIK VIDASI SHIM SCREW	YAY SPRING	ANAHTAR ALLEN KEY
DDJNR/L	1616	H11	16	16	100	20	DNM.. 11 04..						
DDJNR/L	2020	K11	20	20	125	25							
DDJNR/L	2525	M11	25	25	150	32							
DDJNR/L	2020	K15	20	20	125	25	DNM.. 15 06..						
DDJNR/L	2525	M15	25	25	150	32							
DDJNR/L	3232	P15	32	32	170	40							
DDJNR/L	4040	S15	40	40	250	50	DNM..15 04..						
DDJNR/L	2020	K15	20	20	125	25							
DDJNR/L	2525	M15	25	25	150	32							

DDNNN ÜRÜN / PRODUCT 62,5°

TEKNİK ÇİZİM / TECHNICAL DRAWING

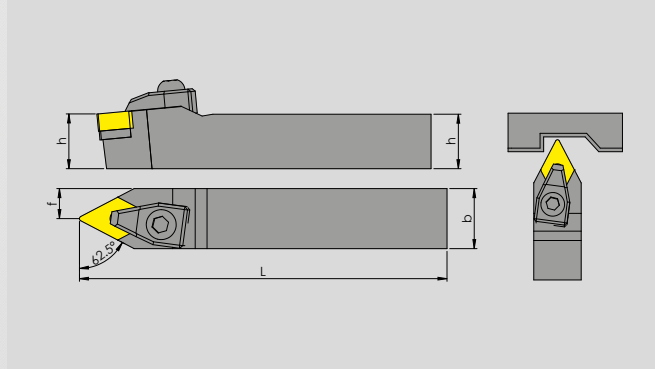

TAKIM KODU ORDERING CODE			KATER ÖLÇÜLERİ DIMENSIONS (mm)				KESİCİ UÇ INSERT	YEDEK PARÇALAR / SPARE PARTS					
			h	b	L	f		BASKI PARÇASI WEDGE CLAMP	BASKI VIDASI SCREW	ALTLIK SHIM	ALTLIK VIDASI SHIM SCREW	YAY SPRING	ANAHTAR ALLEN KEY
DDNNN	2020	K 15	20	20	125	10	DNM.. 15 06..						
DDNNN	2525	M 15	25	25	150	12,5							
DDNNN	3232	P 15	32	32	170	16							
DDNNN	2020	K15	20	20	125	10	DNM.. 15 04..						
DDNNN	2525	M15	25	25	150	12,5							
DDNNN	2525	M 11	25	25	150	12,5							
DDNNN	2020	K 11	20	20	125	10	DNM.. 11 04..						

DDHNR

ÜRÜN / PRODUCT

107,5°

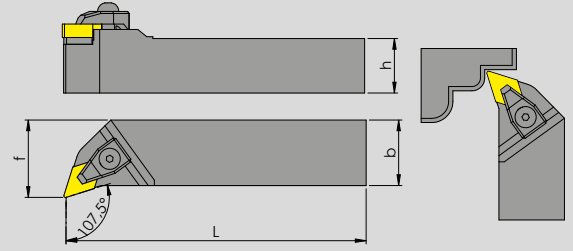

TEKNİK ÇİZİM / TECHNICAL DRAWING

TAKIM KODU
ORDERING CODEKATER ÖLÇÜLERİ
DIMENSIONS (mm)KESİCİ UÇ
INSERT

YEDEK PARÇALAR / SPARE PARTS

			h	b	L	f		BASKI PARÇASI WEDGE CLAMP	BASKI VIDASI SCREW	ALTLIK SHIM	ALTLIK VIDASI SHIM SCREW	YAY SPRING	ANAHTAR ALLEN KEY
DDHNR/L	2020	K 15	20	20	125	25							
DDHNR/L	2525	M 15	25	25	150	32	DNM.. 15 06..	VDP 02	VRV 02 M6	VRDN 15	VAV 02 M5	VRV 01	AA3
DDHNR/L	3232	P 15	32	32	170	40							

DCLNR

ÜRÜN / PRODUCT





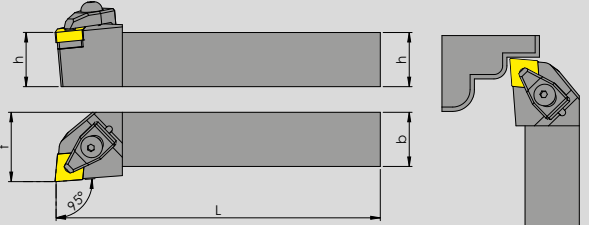

95°



TEKNİK ÇİZİM / TECHNICAL DRAWING

TAKIM KODU
ORDERING CODEKATER ÖLÇÜLERİ
DIMENSIONS (mm)KESİCİ UÇ
INSERT

YEDEK PARÇALAR / SPARE PARTS

			h	b	L	f		BASKI PARÇASI WEDGE CLAMP	BASKI VIDASI SCREW	ALTLIK SHIM	ALTLIK VIDASI SHIM SCREW	YAY SPRING	ANAHTAR ALLEN KEY
DCLNR/L	2020	K 12	20	20	125	25							
DCLNR/L	2525	M 12	25	25	150	32	CNM.. 12 04..	VDP 02	VRV 02 M6	VRCN 12	VAV 02 M5	VRV 01	AA3
DCLNR/L	3232	P 12	32	32	170	40							
DCLNR/L	4040	S 12	40	40	250	50							
DCLNR/L	2525	M 16	25	25	150	32	CNM.. 16 06..	VDP 04	VRV 03 M6	VRCN 16	VAV 04 M5	VRV 02	AA4
DCLNR/L	3232	P 16	32	32	170	40							
DCLNR/L	4040	S 16	40	40	250	50							
DCLNR/L	2525	M 19	25	25	150	32	CNM.. 19 06..	VDP 05	VRV 03 M6	VRCN 19	VAV 05 M6	VRV 02	AA4
DCLNR/L	3232	P 19	32	32	170	40							
DCLNR/L	4040	S 19	40	40	250	50							

DCXNN ÜRÜN / PRODUCT 40°

TEKNİK ÇİZİM / TECHNICAL DRAWING

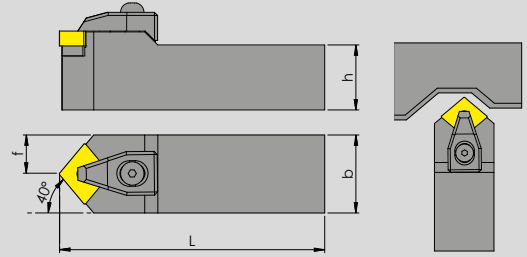

TAKIM KODU ORDERING CODE			KATER ÖLÇÜLERİ DIMENSIONS (mm)				KESİCİ UÇ INSERT	YEDEK PARÇALAR / SPARE PARTS					
								BASKI PARÇASI WEDGE CLAMP	BASKI VIDASI SCREW	ALTLIK SHIM	ALTLIK VIDASI SHIM SCREW	YAY SPRING	ANAHTAR ALLEN KEY
DCXNN	2020	K 12	h	b	L	f	CNM.. 12 04..						
DCXNN	2525	M 12	20	20	125	10		VDP 02	VRV 02 M6	VRCN 12	VAV 02 M5	VR1 01	AA3
DCXNN	3232	P 12	25	25	150	12,5		VDP 04	VRV 03 M6	VRCN 16	VAV 04 M5	VR2 02	AA4
DCXNN	2525	M 16	32	32	170	16	CNM.. 16 06..						
DCXNN	3232	P 16	25	25	150	12,5		VDP 04	VRV 03 M6	VRCN 16	VAV 04 M5	VR2 02	AA4
DCXNN	3232	P 16	32	32	170	16							

DCKNR ÜRÜN / PRODUCT 75°

TEKNİK ÇİZİM / TECHNICAL DRAWING

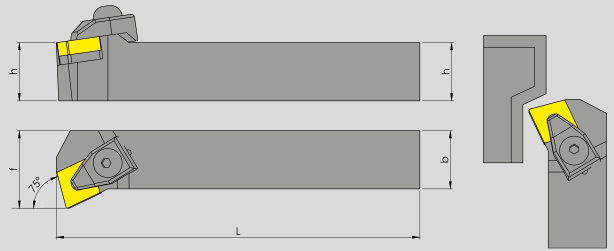

TAKIM KODU ORDERING CODE			KATER ÖLÇÜLERİ DIMENSIONS (mm)				KESİCİ UÇ INSERT	YEDEK PARÇALAR / SPARE PARTS					
								BASKI PARÇASI WEDGE CLAMP	BASKI VIDASI SCREW	ALTLIK SHIM	ALTLIK VIDASI SHIM SCREW	YAY SPRING	ANAHTAR ALLEN KEY
DCKNR/L	2020	K 12	h	b	L	f	CNM.. 12 04..						
DCKNR/L	2525	M 12	20	20	125	25		VDP 02	VRV 02 M6	VRCN 12	VAV 02 M5	VR1 01	AA3
DCKNR/L	3232	P 12	25	25	150	32		VDP 04	VRV 03 M6	VRCN 16	VAV 04 M5	VR2 02	AA4
DCKNR/L	2525	M 16	32	32	170	40	CNM.. 16 06..						
DCKNR/L	3232	P 16	25	25	150	32		VDP 04	VRV 03 M6	VRCN 16	VAV 04 M5	VR2 02	AA4
DCKNR/L	3232	P 16	32	32	170	40							

DCBNR



ÜRÜN / PRODUCT

75°

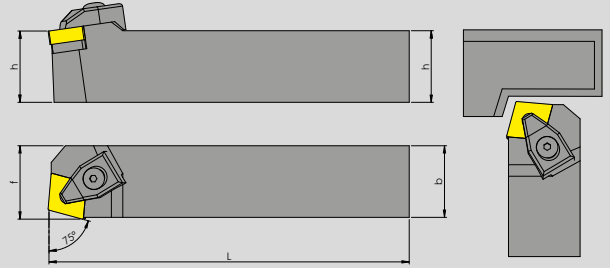

TEKNİK ÇİZİM / TECHNICAL DRAWING



TAKIM KODU ORDERING CODE			KATER ÖLÇÜLERİ DIMENSIONS (mm)				KESİCİ UÇ INSERT	YEDEK PARÇALAR / SPARE PARTS					
								BASKI PARÇASI WEDGE CLAMP	BASKI VIDASI SCREW	ALTLIK SHIM	ALTLIK VIDASI SHIM SCREW	YAY SPRING	ANAHTAR ALLEN KEY
DCBNR/L	2020	K 12	20	20	125	17	 CNM.. 12 04..	VDP 02	VRV 02 M6	VRCN 12	VAV 02 M5	VR1 01	AA3
DCBNR/L	2525	M 12	25	25	150	22		VDP 04	VRV 03 M6	VRCN 16	VAV 04 M5	VR1 02	AA4
DCBNR/L	3232	P 12	32	32	170	29							
DCBNR/L	2525	M 16	25	25	150	22	 CNM.. 16 06..	VDP 04	VRV 03 M6	VRCN 16	VAV 04 M5	VR1 02	AA4
DCBNR/L	3232	P 16	32	32	170	29							

DTGNR

ÜRÜN / PRODUCT

90°



TEKNİK ÇİZİM / TECHNICAL DRAWING

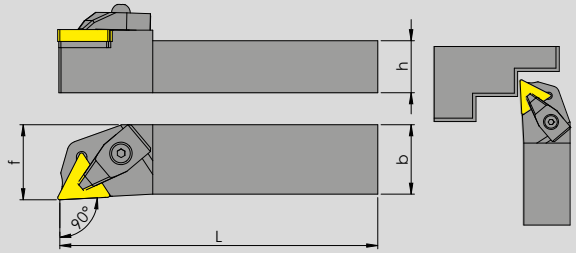

TAKIM KODU ORDERING CODE			KATER ÖLÇÜLERİ DIMENSIONS (mm)				KESİCİ UÇ INSERT	YEDEK PARÇALAR / SPARE PARTS					
								BASKI PARÇASI WEDGE CLAMP	BASKI VIDASI SCREW	ALTLIK SHIM	ALTLIK VIDASI SHIM SCREW	YAY SPRING	ANAHTAR ALLEN KEY
DTGNR/L	2020	K 22	20	20	125	25	 TNM.. 22 04..	VDP 02	VRV 02 M6	VRTN 22	VAV 02 M5	VR1 01	AA3
DTGNR/L	2525	M 22	25	25	150	32		VDP 01	VRV 01 M5	VRTN 16	VAV 11 M5	VR1 01	AA3
DTGNR/L	3232	P 22	32	32	170	40							
DTGNR/L	4040	S 22	40	40	250	50							
DTGNR/L	2020	K 16	20	20	125	25	 TNM.. 16 04..	VDP 01	VRV 01 M5	VRTN 16	VAV 11 M5	VR1 01	AA3
DTGNR/L	2525	M 16	25	25	150	32							
DTGNR/L	3232	P 16	32	32	170	40							

DVQNR

ÜRÜN / PRODUCT

117,5°



TEKNİK ÇİZİM / TECHNICAL DRAWING

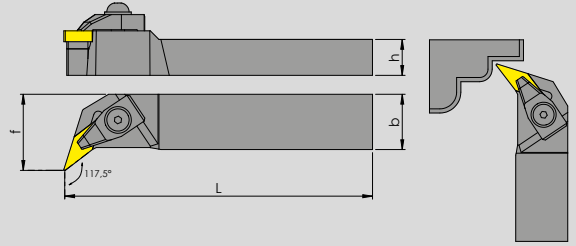

TAKIM KODU ORDERING CODE			KATER ÖLÇÜLERİ DIMENSIONS (mm)				KESİCİ UÇ INSERT	YEDEK PARÇALAR / SPARE PARTS					
								BASKI PARÇASI WEDGE CLAMP	BASKI VIDASI SCREW	ALTLIK SHIM	ALTLIK VIDASI SHIM SCREW	YAY SPRING	ANAHTAR ALLEN KEY
DVQNR/L	2020	K 16	h	b	L	f	 VNM.. 16 04..						
DVQNR/L	2525	M 16	20	20	125	25		VDP 03	VRV 02 M6	VRVB 16	VAV 11 M5	VRV 01	AA3
DVQNR/L	3232	P 16	25	25	150	32							
			32	32	170	40							

DVVNN

ÜRÜN / PRODUCT

72,5°



TEKNİK ÇİZİM / TECHNICAL DRAWING

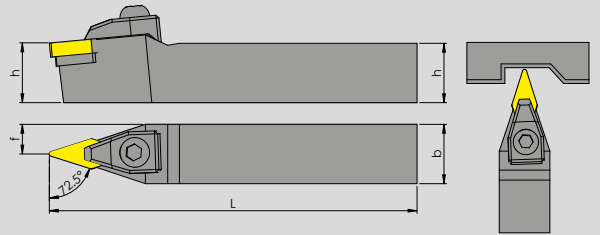

TAKIM KODU ORDERING CODE			KATER ÖLÇÜLERİ DIMENSIONS (mm)				KESİCİ UÇ INSERT	YEDEK PARÇALAR / SPARE PARTS					
								BASKI PARÇASI WEDGE CLAMP	BASKI VIDASI SCREW	ALTLIK SHIM	ALTLIK VIDASI SHIM SCREW	YAY SPRING	ANAHTAR ALLEN KEY
DVVNN	2020	K 16	h	b	L	f	 VNM.. 16 04..						
DVVNN	2525	M 16	20	20	125	25		VDP 03	VRV 02 M6	VRVB 16	VAV 11 M5	VRV 01	AA3
DVVNN	3232	P 16	25	25	150	32							
			32	32	170	40							

DCMNN

ÜRÜN / PRODUCT



50°

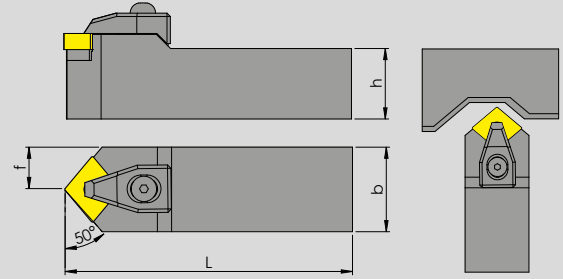

TEKNİK ÇİZİM / TECHNICAL DRAWING

TAKIM KODU
ORDERING CODEKATER ÖLÇÜLERİ
DIMENSIONS (mm)KESİCİ UÇ
INSERT

YEDEK PARÇALAR / SPARE PARTS

			h	b	L	f		BASKI PARÇASI WEDGE CLAMP	BASKI VIDASI SCREW	ALTLIK SHIM	ALTLIK VIDASI SHIM SCREW	YAY SPRING	ANAHTAR ALLEN KEY
DCMNN	2020	K 12	20	20	125	10	CNM.. 12 04..						
DCMNN	2525	M 12	25	25	150	12,5		VDP 02	VRV 02 M6	VRCN 12	VAV 02 M5	VRV 01	AA3
DCMNN	3232	P 12	32	32	170	16	CNM.. 16 06..						
DCMNN	3232	P 16	32	32	170	16		VDP 04	VRV 03 M6	VRCN 16	VAV 04 M5	VRV 02	AA4

DWLNR

ÜRÜN / PRODUCT







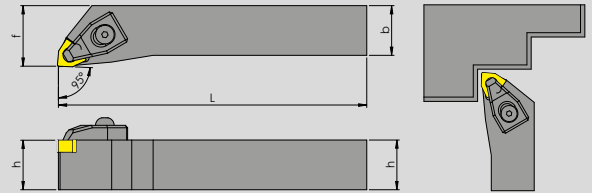





95°



TEKNİK ÇİZİM / TECHNICAL DRAWING

TAKIM KODU
ORDERING CODEKATER ÖLÇÜLERİ
DIMENSIONS (mm)KESİCİ UÇ
INSERT

YEDEK PARÇALAR / SPARE PARTS

			h	b	L	f		BASKI PARÇASI WEDGE CLAMP	BASKI VIDASI SCREW	ALTLIK SHIM	ALTLIK VIDASI SHIM SCREW	YAY SPRING	ANAHTAR ALLEN KEY
DWLNR/L	1616	H 06	16	16	100	20	WNM.. 06 T3..						
DWLNR/L	2020	K 06	20	20	125	25		VDP 01	VRV 01 M5	VRWN 06	VAV 03 M4	VRV 01	AA3
DWLNR/L	2525	M06	25	25	150	32							
DWLNR/L	2020	K 08	20	20	125	25	WNM.. 08 04..						
DWLNR/L	2525	M 08	25	25	150	32		VDP 02	VRV 02 M6	VRWN 08	VAV 02 M5	VRV 01	AA3
DWLNR/L	3232	P 08	32	32	170	40							
DWLNR/L	4040	S 08	40	40	250	50							

DSKNR
ÜRÜN / PRODUCT
75°

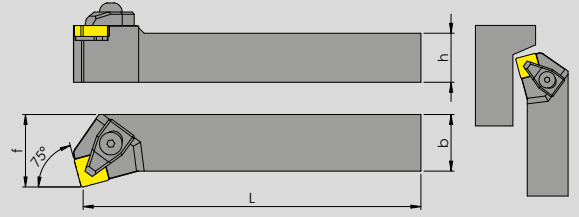
TEKNİK ÇİZİM / TECHNICAL DRAWING

TAKIM KODU ORDERING CODE			KATER ÖLÇÜLERİ DIMENSIONS (mm)				KESİCİ UÇ INSERT	YEDEK PARÇALAR / SPARE PARTS					
								BASKI PARÇASI WEDGE CLAMP	BASKI VİDASI SCREW	ALTLIK SHIM	ALTLIK VİDASI SHIM SCREW	YAY SPRING	ANAHTAR ALLEN KEY
DSKNR/L	2020	K 12	h	b	L	f							
DSKNR/L	2020	K 12	20	20	125	25	SNM.. 12 04..	VDP 02	VRV 02 M6	VRSN 12	VAV 02 M5	VRV 01	AA3
DSKNR/L	2525	M 12	25	25	150	32		VDP 02	VRV 02 M6	VRSN 12	VAV 02 M5	VRV 01	AA3
DSKNR/L	3232	P 12	32	32	170	40		VDP 04	VRV 03 M6	VRSN 15	VAV 04 M5	VRV 02	AA4
DSKNR/L	3232	P 15	32	32	170	40	SNM.. 15 06..	VDP 04	VRV 03 M6	VRSN 15	VAV 04 M5	VRV 02	AA4

DSDNN
ÜRÜN / PRODUCT
45°

TEKNİK ÇİZİM / TECHNICAL DRAWING

TAKIM KODU ORDERING CODE			KATER ÖLÇÜLERİ DIMENSIONS (mm)				KESİCİ UÇ INSERT	YEDEK PARÇALAR / SPARE PARTS					
								BASKI PARÇASI WEDGE CLAMP	BASKI VİDASI SCREW	ALTLIK SHIM	ALTLIK VİDASI SHIM SCREW	YAY SPRING	ANAHTAR ALLEN KEY
DSDNN	2020	K 12	h	b	L	f							
DSDNN	2020	K 12	20	20	125	10	SNM.. 12 04..	VDP 02	VRV 02 M6	VRSN 12	VAV 02 M5	VRV 01	AA3
DSDNN	2525	M 12	25	25	150	12,5		VDP 02	VRV 02 M6	VRSN 12	VAV 02 M5	VRV 01	AA3
DSDNN	3232	P 12	32	32	170	16		VDP 04	VRV 03 M6	VRSN 15	VAV 04 M5	VRV 02	AA4
DSDNN	3232	P 15	32	32	170	16	SNM.. 15 04..	VDP 04	VRV 03 M6	VRSN 15	VAV 04 M5	VRV 02	AA4

DSSNR









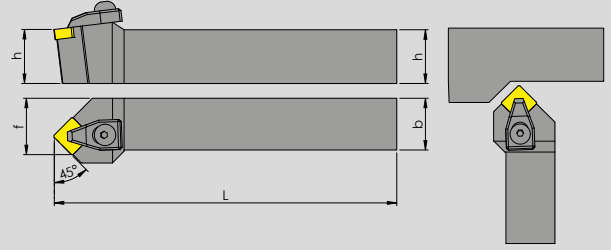









ÜRÜN / PRODUCT

45°



TEKNİK ÇİZİM / TECHNICAL DRAWING



TAKIM KODU ORDERING CODE			KATER ÖLÇÜLERİ DIMENSIONS (mm)				KESİCİ UÇ INSERT	YEDEK PARÇALAR / SPARE PARTS					
			h	b	L	f		BASKI PARÇASI WEDGE CLAMP	BASKI VIDASI SCREW	ALTLIK SHIM	ALTLIK VIDASI SHIM SCREW	YAY SPRING	ANAHTAR ALLEN KEY
DSSNR/L	2020	K 12	20	20	125	25	SNM.. 12 04..						
DSSNR/L	2525	M 12	25	25	150	32		VDP 02	VRV 02 M6	VRSN 12	VAV 02 M5	VRV 01	AA3
DSSNR/L	3232	P 12	32	32	170	40							
DSSNR/L	2525	M 15	25	25	150	32	SNM.. 15 04..						
DSSNR/L	3232	P 15	32	32	170	40		VDP 04	VRV 03 M6	VRSN 15	VAV 04 M5	VRV 02	AA4
DSSNR/L	2525	M 19	25	25	150	32	SNM.. 19 06..						
DSSNR/L	3232	P 19	32	32	170	40		VDP 05	VRV 03 M6	VRSN 19	VAV 05 M6	VRV 02	AA4

DTJNR



ÜRÜN / PRODUCT

93°

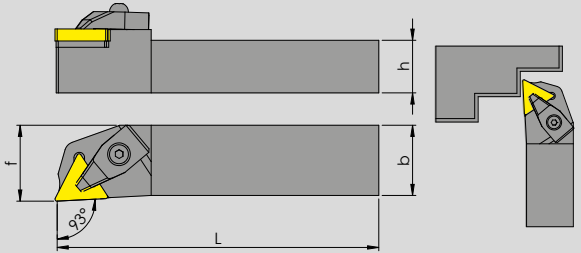

TEKNİK ÇİZİM / TECHNICAL DRAWING



TAKIM KODU ORDERING CODE			KATER ÖLÇÜLERİ DIMENSIONS (mm)				KESİCİ UÇ INSERT	YEDEK PARÇALAR / SPARE PARTS					
			h	b	L	f		BASKI PARÇASI WEDGE CLAMP	BASKI VIDASI SCREW	ALTLIK SHIM	ALTLIK VIDASI SHIM SCREW	YAY SPRING	ANAHTAR ALLEN KEY
DTJNR/L	2020	K 22	20	20	125	25	TNM.. 22 04..						
DTJNR/L	2525	M 22	25	25	150	32		VDP 02	VRV 02 M6	VRTN 22	VAV 02 M5	VRV 02	AA3
DTJNR/L	3232	P 22	32	32	170	40							
DTJNR/L	2020	K 16	20	20	125	25	TNM.. 16 04..						
DTJNR/L	2525	M 16	25	25	150	32		VDP 01	VRV 01 M5	VRTN 16	VAV 11 M5	VRV 01	AA3
DTJNR/L	3232	P 16	32	32	170	40							

DVJNR

ÜRÜN / PRODUCT

93°



TEKNİK ÇİZİM / TECHNICAL DRAWING

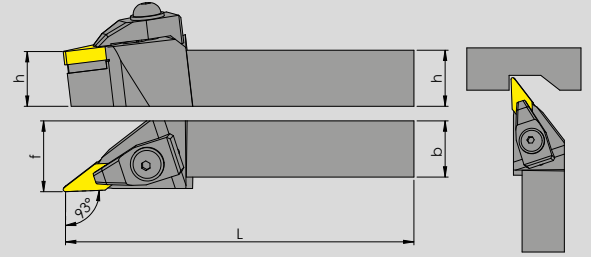

TAKIM KODU ORDERING CODE		KATER ÖLÇÜLERİ DIMENSIONS (mm)				KESİCİ UÇ INSERT	YEDEK PARÇALAR / SPARE PARTS						
		h	b	L	f		BASKI PARÇASI WEDGE CLAMP	BASKI VİDASI SCREW	ALTLIK SHIM	ALTLIK VİDASI SHIM SCREW	YAY SPRING	ANAHTAR ALLEN KEY	
DVJNR/L	1616	H 16	16	16	100	20	 VNM.. 16 04..						
DVJNR/L	2020	K 16	20	20	125	25		VDP 03	VRV 02 M6	VRVB 16	VAV 11 M5	VR1 01	AA3
DVJNR/L	2525	M 16	25	25	150	32							
DVJNR/L	3232	P 16	32	32	170	40							

DVHNR

ÜRÜN / PRODUCT

107,5°



TEKNİK ÇİZİM / TECHNICAL DRAWING

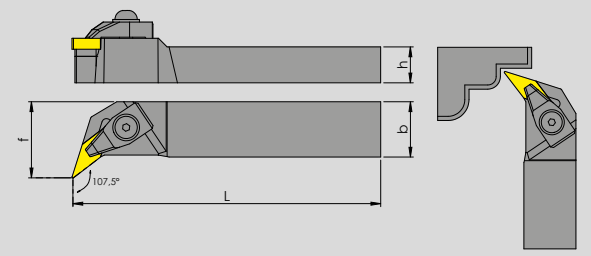

TAKIM KODU ORDERING CODE		KATER ÖLÇÜLERİ DIMENSIONS (mm)				KESİCİ UÇ INSERT	YEDEK PARÇALAR / SPARE PARTS						
		h	b	L	f		BASKI PARÇASI WEDGE CLAMP	BASKI VİDASI SCREW	ALTLIK SHIM	ALTLIK VİDASI SHIM SCREW	YAY SPRING	ANAHTAR ALLEN KEY	
DVHNR/L	2020	K 16	20	20	125	25	 VNM.. 16 04..						
DVHNR/L	2525	M 16	25	25	150	32		VDP 03	VRV 02 M6	VRVB 16	VAV 11 M5	VR1 01	AA3
DVHNR/L	3232	P 16	32	32	170	40							



M SİSTEM DIŐ **TORNA KATERLERİ**

M System external
lathe tool holders
www.vorgen.com



The **red** power for
the professionals
Profesyoneller İin
Kırmızı G

MWLNR

ÜRÜN / PRODUCT

95°



TEKNİK ÇİZİM / TECHNICAL DRAWING

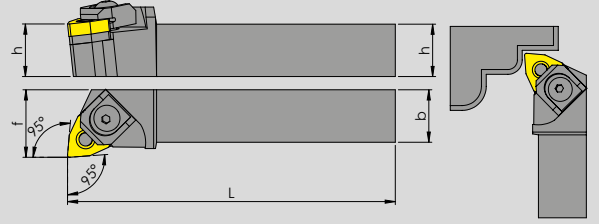

TAKIM KODU ORDERING CODE			KATER ÖLÇÜLERİ DIMENSIONS (mm)				KESİCİ UÇ INSERT	YEDEK PARÇALAR / SPARE PARTS					
								BASKI PARÇASI WEDGE CLAMP	BASKI VIDASI SCREW	ALTLIK SHIM	ALTLIK VIDASI SHIM SCREW	YAY SPRING	ANAHTAR ALLEN KEY
MWLNR/L	2020	K 08	h	b	L	f	WNM.. 08 04..						
MWLNR/L	2525	M 08	20	20	125	25		VMP 02	VRV 02 M6	VRWN 08	VAV 10 M6	VRV 01	AA3
MWLNR/L	3232	P 08	25	25	150	32		VMP 01	VRV 01 M5	VRWN 06	VAV 08 M5	VRV 01	AA3
MWLNR/L	4040	S 08	32	32	170	40							
MWLNR/L	2020	K 06	20	20	125	25	WNM.. 06 T3..						
MWLNR/L	2525	M 06	25	25	150	32		VMP 01	VRV 01 M5	VRWN 06	VAV 08 M5	VRV 01	AA3

MWENN

ÜRÜN / PRODUCT

50°



TEKNİK ÇİZİM / TECHNICAL DRAWING

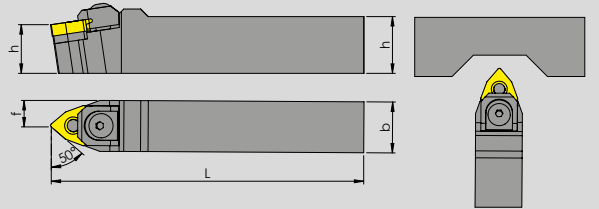

TAKIM KODU ORDERING CODE			KATER ÖLÇÜLERİ DIMENSIONS (mm)				KESİCİ UÇ INSERT	YEDEK PARÇALAR / SPARE PARTS					
								BASKI PARÇASI WEDGE CLAMP	BASKI VIDASI SCREW	ALTLIK SHIM	ALTLIK VIDASI SHIM SCREW	YAY SPRING	ANAHTAR ALLEN KEY
MWENN	2020	K 08	h	b	L	f	WNM.. 08 04..						
MWENN	2525	M 08	20	20	125	10		VMP 02	VRV 02 M6	VRWN 08	VAV 10 M6	VRV 01	AA3
MWENN	3232	P 08	25	25	150	12,5		VMP 01	VRV 01 M5	VRWN 06	VAV 08 M5	VRV 01	AA3
MWENN	2020	K 06	20	20	125	10	WNM.. 06 T3..						
MWENN	2525	M 06	25	25	150	12,5		VMP 01	VRV 01 M5	VRWN 06	VAV 08 M5	VRV 01	AA3

MTENN

ÜRÜN / PRODUCT

60°



TEKNİK ÇİZİM / TECHNICAL DRAWING

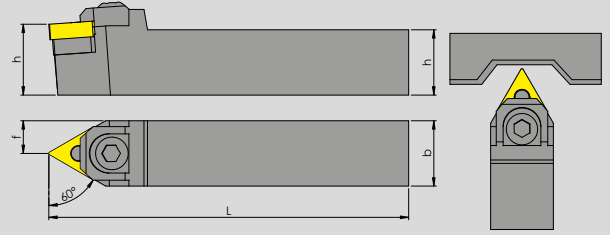

TAKIM KODU ORDERING CODE			KATER ÖLÇÜLERİ DIMENSIONS (mm)				KESİCİ UÇ INSERT	YEDEK PARÇALAR / SPARE PARTS					
								BASKI PARÇASI WEDGE CLAMP	BASKI VIDASI SCREW	ALTLIK SHIM	ALTLIK VIDASI SHIM SCREW	YAY SPRING	ANAHTAR ALLEN KEY
MTENN	2020	K 16	20	20	125	10	 TNM.. 16 04..						
MTENN	2525	M 16	25	25	150	12,5		VMP 03	VRV 01 M5	VRTN 16	VAV 08 M5	VRV 01	AA3
MTENN	3232	P 16	32	32	170	16							
MTENN	2525	M 22	25	25	150	12,5	 TNM.. 22 04..						
MTENN	3232	P 22	32	32	170	16		VMP 04	VRV 02 M6	VRTN 22	VAV 02 M5	VRV 01	AA3

MTJNR









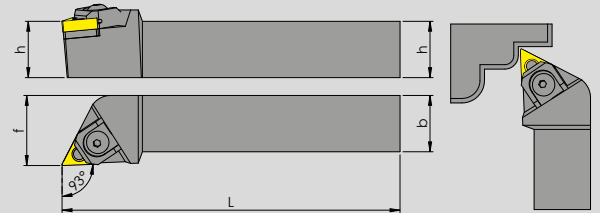





ÜRÜN / PRODUCT

93°



TEKNİK ÇİZİM / TECHNICAL DRAWING



TAKIM KODU ORDERING CODE			KATER ÖLÇÜLERİ DIMENSIONS (mm)				KESİCİ UÇ INSERT	YEDEK PARÇALAR / SPARE PARTS					
								BASKI PARÇASI WEDGE CLAMP	BASKI VIDASI SCREW	ALTLIK SHIM	ALTLIK VIDASI SHIM SCREW	YAY SPRING	ANAHTAR ALLEN KEY
MTJNR/L	2020	K 16	20	20	125	25	 TNM.. 16 04..						
MTJNR/L	2525	M 16	25	25	150	32		VMP 03	VRV 01 M5	VRTN 16	VAV 08 M5	VRV 01	AA3
MTJNR/L	3232	P 16	32	32	170	40							
MTJNR/L	2020	K 22	20	20	125	25	 TNM.. 22 04..						
MTJNR/L	2525	M 22	25	25	150	32		VMP 04	VRV 02 M6	VRTN 22	VAV 10 M6	VRV 01	AA3
MTJNR/L	3232	P 22	32	32	170	40							
MTJNR/L	4040	S 22	40	40	250	50							



C SİSTEM DIŞ
TORNA KATERLERİ

C System external
lathe tool holders
www.vorgen.com



The red power for
the professionals
Profesyoneller için
Kırmızı Güç

CKJNR

ÜRÜN / PRODUCT

93°



TEKNİK ÇİZİM / TECHNICAL DRAWING

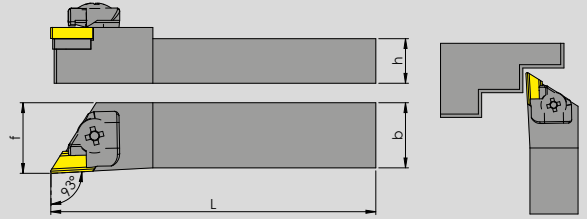

TAKIM KODU ORDERING CODE			KATER ÖLÇÜLERİ DIMENSIONS (mm)				KESİCİ UÇ INSERT	YEDEK PARÇALAR / SPARE PARTS					
								BASKI PARÇASI WEDGE CLAMP	BASKI VİDASI SCREW	ALTLIK SHIM	ALTLIK VİDASI SHIM SCREW	YAY SPRING	ANAHTAR ALLEN KEY
CKJNR/L	2020	K 16	20	20	125	25	 KNUX16 R/L						
CKJNR/L	2525	M 16	25	25	150	32		VCP 01	VRV 04 M6	VRKN 16 R/L	VAV 01 M3	VRY 02	AA4
CKJNR/L	3232	P 16	32	32	170	40							
CKJNR/L	4040	S16	40	40	250	50							

CTGPR







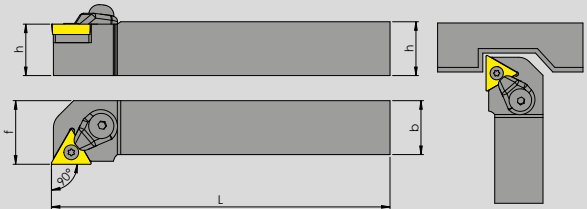

ÜRÜN / PRODUCT

90°



TEKNİK ÇİZİM / TECHNICAL DRAWING



TAKIM KODU ORDERING CODE			KATER ÖLÇÜLERİ DIMENSIONS (mm)				KESİCİ UÇ INSERT	YEDEK PARÇALAR / SPARE PARTS				
								BASKI PARÇASI WEDGE CLAMP	BASKI VİDASI SCREW	ALTLIK SHIM	ALTLIK VİDASI SHIM SCREW	ANAHTAR TORX KEY
CTGPR/L	2020	K 16	20	20	125	25	 TP 1603..					
CTGPR/L	2525	M 16	25	25	150	32		VCP 03	VRT 09 M4x11			T15
CTGPR/L	2525	M 22	25	25	150	32	 TP 2204..					
CTGPR/L	3232	P 22	32	32	170	40		VCP 04	VRV 04 M6	VRTP 22	VAV 02 M5	T20

CSDNN

ÜRÜN / PRODUCT

45°



TEKNİK ÇİZİM / TECHNICAL DRAWING

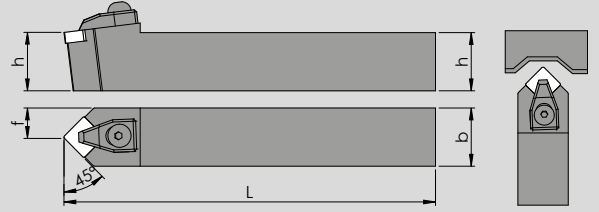

TAKIM KODU ORDERING CODE			KATER ÖLÇÜLERİ DIMENSIONS (mm)				KESİCİ UÇ INSERT	YEDEK PARÇALAR / SPARE PARTS					
			h	b	L	f		BASKI PARÇASI WEDGE CLAMP	BASKI VIDASI SCREW	ALTLIK SHIM	ALTLIK VIDASI SHIM SCREW	YAY SPRING	ANAHTAR ALLEN KEY
CSDNN	2525	M 12	25	25	150	12,5	SNM.. 12 04..	VCP 07	VRV 07 M6	VRSN 12	VAV 02 M5		AA4
CSDNN	3232	P 12	32	32	170	16							

CSSNR

ÜRÜN / PRODUCT

45°



TEKNİK ÇİZİM / TECHNICAL DRAWING

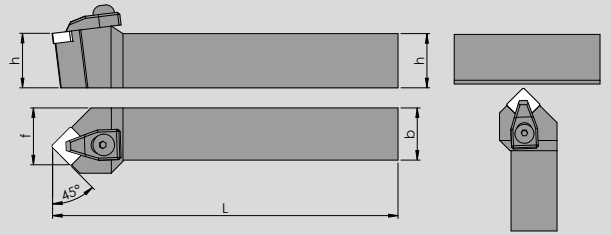

TAKIM KODU ORDERING CODE			KATER ÖLÇÜLERİ DIMENSIONS (mm)				KESİCİ UÇ INSERT	YEDEK PARÇALAR / SPARE PARTS					
			h	b	L	f		BASKI PARÇASI WEDGE CLAMP	BASKI VIDASI SCREW	ALTLIK SHIM	ALTLIK VIDASI SHIM SCREW	YAY SPRING	ANAHTAR ALLEN KEY
CSSNR	2525	M 12	25	25	150	12,5	SNM.. 12 04..	VCP 07	VRV 07 M6	VRSN 12	VAV 02 M5		AA4
CSSNR	3232	P 12	32	32	170	16							

CDJNR

ÜRÜN / PRODUCT

93°



TEKNİK ÇİZİM / TECHNICAL DRAWING

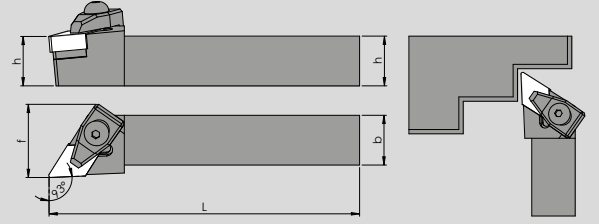

TAKIM KODU ORDERING CODE			KATER ÖLÇÜLERİ DIMENSIONS (mm)				KESİCİ UÇ INSERT	YEDEK PARÇALAR / SPARE PARTS					
								BASKI PARÇASI WEDGE CLAMP	BASKI VIDASI SCREW	ALTLIK SHIM	ALTLIK VIDASI SHIM SCREW	YAY SPRING	ANAHTAR ALLEN KEY
CDJNR/L	2525	M15	h	b	L	f							
CDJNR/L	3232	P15	25	25	150	32	DNM.. 15 06..	VCP 07	VRV 07 M6	VRDN 15	VAV 02 M5		AA4



The **red power** for
the professionals
Profesyoneller için
KIRMIZI GÜÇ

 **VOF**
SDNC



S SİSTEM DIŞ
TORNA KATERLERİ
S System external
lathe tool holders

www.vorgen.com



SRHCR

ÜRÜN / PRODUCT



TEKNİK ÇİZİM / TECHNICAL DRAWING

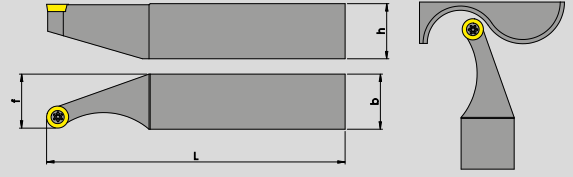

TAKIM KODU ORDERING CODE			KATER ÖLÇÜLERİ DIMENSIONS (mm)				KESİCİ UÇ INSERT	YEDEK PARÇALAR / SPARE PARTS			
								BASKI PARÇASI WEDGE CLAMP	BASKI VİDASI SCREW	ALTLIK VİDASI SHIM SCREW	ANAHTAR TORX KEY
SRHCR/L	2525	K 10	h	b	L	f					
SRHCR/L	2525	K 12	25	25	125	25	RC.. 10		VRT 07 M3,5x11		T15
SRHCR/L	2525	K 12	25	25	125	25	RC.. 12		VRT 07 M3,5x11		T15

STTCN

ÜRÜN / PRODUCT

90°



TEKNİK ÇİZİM / TECHNICAL DRAWING



TAKIM KODU ORDERING CODE			KATER ÖLÇÜLERİ DIMENSIONS (mm)				KESİCİ UÇ INSERT	YEDEK PARÇALAR / SPARE PARTS			
								SIKMA VİDASI SCREW	ALTLIK SHIM	ALTLIK VİDASI SHIM SCREW	ANAHTAR TORX KEY
STTCN	2525	P 11	h	b	L	f					
STTCN	2525	P 11	25	25	170	12,5	TC.. 11 02..	VRT 04 M2,5x7			T08
STTCN	2525	P 16	25	25	170	12,5	TC.. 16 T3..	VRT 07 M3,5x11			T15
STTCN	3232	P 16	32	32	170	16					
STTCN	3232	P 22	32	32	170	16	TC.. 22 04..	VRT 11 M4,5x16			T20

STJCR



ÜRÜN / PRODUCT

93°

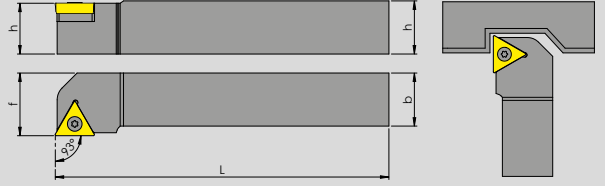

TEKNİK ÇİZİM / TECHNICAL DRAWING



TAKIM KODU ORDERING CODE		KATER ÖLÇÜLERİ DIMENSIONS (mm)					KESİCİ UÇ INSERT	YEDEK PARÇALAR / SPARE PARTS			
		h	b	L	f	BASKI VİDASI SCREW		ALTLIK SHIM	ALTLIK VİDASI SHIM SCREW	ANAHTAR TORX KEY	
STJCR/L	1616	H 16	16	16	100	20	TC.. 16 T3..				
STJCR/L	2020	K 16	20	20	125	25		VRT 07 M3,5x11	VRTC 16	VAV 06 M5.05	T15
STJCR/L	2525	M 16	25	25	150	32					
STJCR/L	3232	P 16	32	32	170	40					

SCACR



ÜRÜN / PRODUCT

90°

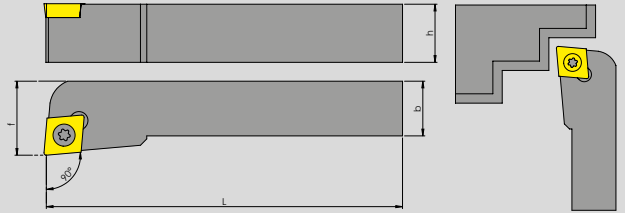

TEKNİK ÇİZİM / TECHNICAL DRAWING



TAKIM KODU ORDERING CODE		KATER ÖLÇÜLERİ DIMENSIONS (mm)					KESİCİ UÇ INSERT	YEDEK PARÇALAR / SPARE PARTS			
		h	b	L	f	BASKI VİDASI SCREW		ALTLIK SHIM	ALTLIK VİDASI SHIM SCREW	ANAHTAR TORX KEY	
SCACR/L	1212	F 09	12	12	80	16	CCM.. 09 T3..	VRT 06 M3,5x9			
SCACR/L	1616	H 09	16	16	100	20	CCM.. 09 T3..	VRT 07 M3,5x11	VRCM 09	VAV 06 M5.05	T15
SCACR/L	2020	K 09	20	20	125	25					
SCACR/L	2525	M 09	25	25	150	32					
SCACR/L	2020	K 12	20	20	125	25	CCM.. 12 04..	VRT 10 M4,5x12			T20
SCACR/L	2525	M 12	25	25	150	32					

SSDCN

ÜRÜN / PRODUCT

45°



TEKNİK ÇİZİM / TECHNICAL DRAWING



TAKIM KODU ORDERING CODE			KATER ÖLÇÜLERİ DIMENSIONS (mm)				KESİCİ UÇ INSERT	YEDEK PARÇALAR / SPARE PARTS			
								BASKI VİDASI SCREW	ALTLIK SHIM	ALTLIK VİDASI SHIM SCREW	ANAHTAR TORX KEY
SSDCN	2020	K 12	h	b	L	f					
SSDCN	2525	M 12	20	20	125	10	SC.T.. 12 04..	VRT 10 M4,5x12	VRSC 12	VAV 06 M5.05	T20
SSDCN	2525	M 12	25	25	150	12,5					

SDJCR

ÜRÜN / PRODUCT

93°



TEKNİK ÇİZİM / TECHNICAL DRAWING



TAKIM KODU ORDERING CODE			KATER ÖLÇÜLERİ DIMENSIONS (mm)				KESİCİ UÇ INSERT	YEDEK PARÇALAR / SPARE PARTS			
								BASKI VİDASI SCREW	ALTLIK SHIM	ALTLIK VİDASI SHIM SCREW	ANAHTAR TORX KEY
SDJCR/L	0808	H 07	h	b	L	f					
SDJCR/L	1010	H 07	08	08	100	10	DCM.. 07 T3..	VRT 04 M2,5x7			T08
SDJCR/L	1212	F 07	10	10	100	12					
SDJCR/L	1212	F 11	12	12	80	16	DCM.. 11 T3..	VRT 06 M3,5x9			T15
SDJCR/L	1616	H 11	12	12	80	16	DCM.. 11 T3..	VRT 07 M3,5x11	VRDC 11	VAV 06 M5.05	T15
SDJCR/L	2020	K 11	16	16	100	20					
SDJCR/L	2525	M 11	16	16	100	25					
SDJCR/L	3232	P 11	20	20	125	25					
SDJCR/L	2525	M 11	25	25	150	32					
SDJCR/L	3232	P 11	32	32	170	40					

SDHCR





ÜRÜN / PRODUCT

107,5°

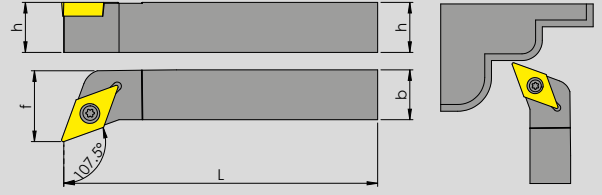

TEKNİK ÇİZİM / TECHNICAL DRAWING



TAKIM KODU ORDERING CODE			KATER ÖLÇÜLERİ DIMENSIONS (mm)				KESİCİ UÇ INSERT	YEDEK PARÇALAR / SPARE PARTS			
								BASKI VİDASI SCREW	ALTLIK SHIM	ALTLIK VİDASI SHIM SCREW	ANAHTAR TORX KEY
			h	b	L	f					
SDHCR/L	2020	K 11	20	20	125	25	DCM.. 11 T3..	VRT 07 M3,5x11	VRDC 11	VAV 06 M5.05	T15
SDHCR/L	2525	M 11	25	25	150	32					

STGCR

ÜRÜN / PRODUCT

90°



TEKNİK ÇİZİM / TECHNICAL DRAWING

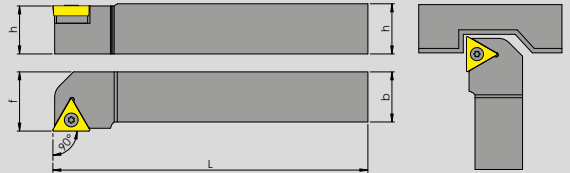

TAKIM KODU ORDERING CODE			KATER ÖLÇÜLERİ DIMENSIONS (mm)				KESİCİ UÇ INSERT	YEDEK PARÇALAR / SPARE PARTS			
								BASKI VİDASI SCREW	ALTLIK SHIM	ALTLIK VİDASI SHIM SCREW	ANAHTAR TORX KEY
			h	b	L	f					
STGCR/L	1616	H 16	16	16	100	20	TC.. 16 T3..	VRT 07 M3,5x11	VRTC 16	VAV 06 M5.05	T15
STGCR/L	2020	K 16	20	20	125	25					
STGCR/L	2525	M 16	25	25	150	32					
STGCR/L	3232	P 16	32	32	170	40					

SDNCN

ÜRÜN / PRODUCT

62,5°



TEKNİK ÇİZİM / TECHNICAL DRAWING

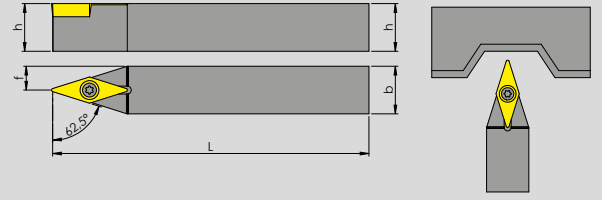

TAKIM KODU ORDERING CODE			KATER ÖLÇÜLERİ DIMENSIONS (mm)				KESİCİ UÇ INSERT	YEDEK PARÇALAR / SPARE PARTS			
								BASKI VİDASI SCREW	ALTLIK SHIM	ALTLIK VİDASI SHIM SCREW	ANAHTAR TORX KEY
SDNCN	1212	F 07	12	12	80	6					
SDNCN	1212	F 11	12	12	80	6	DCM.. 11 T3..	VRT 06 M3,5x9			T15
SDNCN	1616	H 11	16	16	100	8	DCM.. 11 T3..	VRT 07 M3,5x11	VRDC 11	VAV 06 M5.05	T15
SDNCN	2020	K 11	20	20	125	10					
SDNCN	2525	M 11	25	25	150	12,5					
SDNCN	3232	P 11	32	32	170	16					

SVJBR

ÜRÜN / PRODUCT

93°



TEKNİK ÇİZİM / TECHNICAL DRAWING

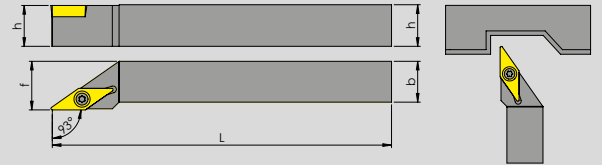

TAKIM KODU ORDERING CODE			KATER ÖLÇÜLERİ DIMENSIONS (mm)				KESİCİ UÇ INSERT	YEDEK PARÇALAR / SPARE PARTS			
								BASKI VİDASI SCREW	ALTLIK SHIM	ALTLIK VİDASI SHIM SCREW	ANAHTAR TORX KEY
SVJBR/L	1212	F 11	12	12	80	16					
SVJBR/L	1616	H 11	16	16	100	20	VBM.. 11 03..	VRT 04 M2,5x7			T08
SVJBR/L	2020	K 11	20	20	125	25					
SVJBR/L	2020	K 16	20	20	125	25	VBM.. 16 04..	VRT 07 M3,5x11	VRVB 16	VAV 06 M5.05	T15
SVJBR/L	2525	M 16	25	25	150	32					
SVJBR/L	3232	P 16	32	32	170	40					

SVVBN



ÜRÜN / PRODUCT

72,5°

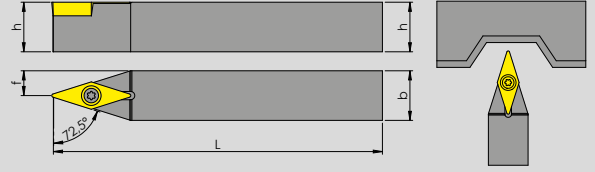

TEKNİK ÇİZİM / TECHNICAL DRAWING



TAKIM KODU ORDERING CODE			KATER ÖLÇÜLERİ DIMENSIONS (mm)				KESİCİ UÇ INSERT	YEDEK PARÇALAR / SPARE PARTS			
								BASKI VİDASI SCREW	ALTLIK SHIM	ALTLIK VİDASI SHIM SCREW	ANAHTAR TORX KEY
SVVBN	1212	F 11	h	b	L	f	 VBM.. 11 03..	 VRT 04 M2,5x7			 T08
SVVBN	1616	H 11	12	12	80	6					
SVVBN	2020	K 11	16	16	100	8					
SVVBN	2020	K 16	20	20	125	10	VBM.. 16 04..	VRT 07 M3,5x11	VRVB 16	VAV 06 M5.05	T15
SVVBN	2525	M 16	25	25	150	12,5					
SVVBN	3232	P 16	32	32	170	16					

SVHBR

ÜRÜN / PRODUCT

107,5°



TEKNİK ÇİZİM / TECHNICAL DRAWING

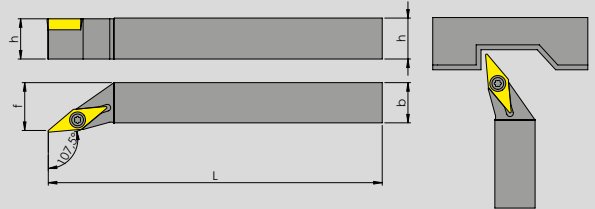

TAKIM KODU ORDERING CODE			KATER ÖLÇÜLERİ DIMENSIONS (mm)				KESİCİ UÇ INSERT	YEDEK PARÇALAR / SPARE PARTS			
								BASKI VİDASI SCREW	ALTLIK SHIM	ALTLIK VİDASI SHIM SCREW	ANAHTAR TORX KEY
SVHBR/L	1212	F 11	h	b	L	f	 VBM.. 11 03..	 VRT 04 M2,5x7			 T08
SVHBR/L	1616	H 11	12	12	80	16					
SVHBR/L	2020	K 11	16	16	100	20					
SVHBR/L	2020	K 16	20	20	125	25	VBM.. 16 04..	VRT 07 M3,5x11	VRVB 16	VAV 06 M5.05	T15
SVHBR/L	2525	M 16	25	25	150	32					
SVHBR/L	3232	P 16	32	25	170	40					

SVHCR

ÜRÜN / PRODUCT

107,5°



TEKNİK ÇİZİM / TECHNICAL DRAWING



TAKIM KODU ORDERING CODE			KATER ÖLÇÜLERİ DIMENSIONS (mm)				KESİCİ UÇ INSERT	YEDEK PARÇALAR / SPARE PARTS			
								BASKI VİDASI SCREW	ALTLIK SHIM	ALTLIK VİDASI SHIM SCREW	ANAHTAR TORX KEY
			h	b	L	f					
SVHCR/L	1212	F 11	12	12	80	16	VCM.. 11 03..	VRT 04 M2,5x7			T08
SVHCR/L	1616	H 11	16	16	100	20					
SVHCR/L	2020	K 11	20	20	125	25					
SVHCR/L	2020	K 16	20	20	125	25	VCM.. 16 04..	VRT 07 M3,5x11	VRVB 16	VAV 06 M5.05	T15
SVHCR/L	2525	M 16	25	25	150	32					
SVHCR/L	3232	P 16	32	25	170	40					

SVJCR

ÜRÜN / PRODUCT

93°



TEKNİK ÇİZİM / TECHNICAL DRAWING



TAKIM KODU ORDERING CODE			KATER ÖLÇÜLERİ DIMENSIONS (mm)				KESİCİ UÇ INSERT	YEDEK PARÇALAR / SPARE PARTS			
								BASKI VİDASI SCREW	ALTLIK SHIM	ALTLIK VİDASI SHIM SCREW	ANAHTAR TORX KEY
			h	b	L	f					
SVJCR/L	1212	F 11	12	12	80	16	VCM.. 11 03..	VRT 04 M2,5x7			T08
SVJCR/L	1616	H 11	16	16	100	20					
SVJCR/L	2020	K 11	20	20	125	25					
SVJCR/L	2020	K 16	20	20	125	25	VCM.. 16 04..	VRT 07 M3,5x11	VRVB 16	VAV 06 M5.05	T15
SVJCR/L	2525	M 16	25	25	150	32					
SVJCR/L	3232	P 16	32	32	170	40					

SVVCN

ÜRÜN / PRODUCT

72,5°



TEKNİK ÇİZİM / TECHNICAL DRAWING

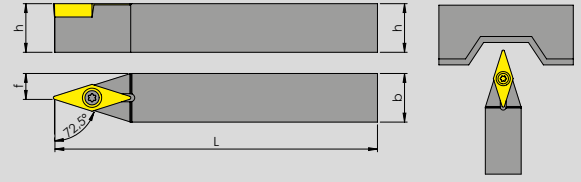

TAKIM KODU ORDERING CODE			KATER ÖLÇÜLERİ DIMENSIONS (mm)				KESİCİ UÇ INSERT	YEDEK PARÇALAR / SPARE PARTS			
								BASKI VİDASI SCREW	ALTLIK SHIM	ALTLIK VİDASI SHIM SCREW	ANAHTAR TORX KEY
SVVCN	1212	F 11	12	12	80	6	VCM.. 11 03..	VRT 04 M2,5x7			T08
SVVCN	1616	H 11	16	16	100	8					
SVVCN	2020	K 11	20	20	125	10					
SVVCN	2020	K 16	20	20	125	10	VCM.. 16 04..	VRT 07 M3,5x11	VRVB 16	VAV 06 M5.05	T15
SVVCN	2525	M 16	25	25	150	12,5					
SVVCN	3232	P 16	32	25	170	16					

SCLCR

ÜRÜN / PRODUCT

95°



TEKNİK ÇİZİM / TECHNICAL DRAWING

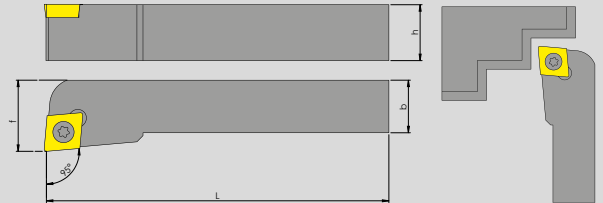

TAKIM KODU ORDERING CODE			KATER ÖLÇÜLERİ DIMENSIONS (mm)				KESİCİ UÇ INSERT	YEDEK PARÇALAR / SPARE PARTS			
								BASKI VİDASI SCREW	ALTLIK SHIM	ALTLIK VİDASI SHIM SCREW	ANAHTAR TORX KEY
SCLCR/L	0808	H 06	08	08	100	10	CCM.. 06 02..	VRT 04 M2,5x7			T08
SCLCR/L	1010	H 06	10	10	100	12					
SCLCR/L	1212	H 06	12	12	100	16					
SCLCR/L	1212	F 09	12	12	80	16	CCM.. 09 T3..	VRT 06 M3,5x9			T15
SCLCR/L	1616	H 09	16	16	100	20	CCM.. 09 T3..	VRT 07 M3,5x11	VRCM 09	VAV 06 M5.05	T15
SCLCR/L	2020	K 09	20	20	125	25					
SCLCR/L	2525	M 09	25	25	150	32					
SCLCR/L	2525	K 12	20	20	125	25	CCM.. 12 04..	VRT 10 M4,5x12			T20
SCLCR/L	2525	M 12	25	25	150	32					

SRDCN
ÜRÜN / PRODUCT

TEKNİK ÇİZİM / TECHNICAL DRAWING

TAKIM KODU ORDERING CODE			KATER ÖLÇÜLERİ DIMENSIONS (mm)				KESİCİ UÇ INSERT	YEDEK PARÇALAR / SPARE PARTS			
								BASKI PARÇASI WEDGE CLAMP	BASKI VİDASI SCREW	ALTLIK VİDASI SHIM SCREW	ANAHTAR TORX KEY
SRDCN	2020	K 06	20	20	125	10	RC.. 06			VRT 04 M2,5x7	T08
SRDCN	2525	M 06	25	25	150	12,5					
SRDCN	2020	K 08	20	20	125	10	RC.. 08			VRT 05 M3x8	T10
SRDCN	2525	M 08	25	25	150	12,5					
SRDCN	3232	P 08	32	32	170	16	RC.. 10	VCP 03	VRT 09 M4x11	VRT 06 M3,5x9	T15
SRDCN	2020	K 10	20	20	125	10					
SRDCN	2525	M 10	25	25	150	12,5	RC.. 12	VCP 03	VRT 09 M4x11	VRT 06 M3,5x9	T15
SRDCN	3232	P 10	32	32	170	16					
SRDCN	2020	K 12	20	20	125	10	RC.. 16	VCP 04	VRT 12 M4x16	VRT 13 M5x12	T20
SRDCN	2525	M 12	25	25	150	12,5					
SRDCN	3232	P 12	32	32	170	16	RC.. 20	VCP 04	VRT 12 M4x16	VRT 12 M6x16	T20
SRDCN	2020	K 16	20	20	125	10					
SRDCN	2525	M 16	25	25	150	12,5	RC.. 20	VCP 04	VRT 12 M4x16	VRT 12 M6x16	T20
SRDCN	3232	P 16	32	32	170	16					
SRDCN	2525	M 20	25	25	150	12,5	RC.. 20	VCP 04	VRT 12 M4x16	VRT 12 M6x16	T20
SRDCN	3232	P 20	32	32	170	16					
SRDCN	4040	S 20	40	40	250	50	RC.. 20	VCP 04	VRT 12 M4x16	VRT 12 M6x16	T20

SSSCR
ÜRÜN / PRODUCT
45°

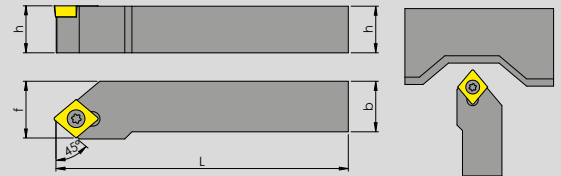
TEKNİK ÇİZİM / TECHNICAL DRAWING

TAKIM KODU ORDERING CODE			KATER ÖLÇÜLERİ DIMENSIONS (mm)				KESİCİ UÇ INSERT	YEDEK PARÇALAR / SPARE PARTS			
								BASKI VİDASI SCREW	ALTLIK SHIM	ALTLIK VİDASI SHIM SCREW	ANAHTAR TORX KEY
SSSCR/L	2020	K 12	20	20	125	25	SC.T.. 12 04..			VAV 07 M6	T20
SSSCR/L	2525	M 12	25	25	150	32					



SCMCN





ÜRÜN / PRODUCT

50°



TEKNİK ÇİZİM / TECHNICAL DRAWING



TAKIM KODU ORDERING CODE			KATER ÖLÇÜLERİ DIMENSIONS (mm)				KESİCİ UÇ INSERT	YEDEK PARÇALAR / SPARE PARTS			
								BASKI VİDASI SCREW	ALTLIK SHIM	ALTLIK VİDASI SHIM SCREW	ANAHTAR TORX KEY
SCMCN	1212	F 09	12	12	80	06					
SCMCN	1616	H 09	16	16	100	08	CCM.. 09 T3..	VRT 07 M3,5x11	VRCM 09	VAV 06 M5.05	T15
SCMCN	2020	K 09	20	20	125	10					
SCMCN	2525	M 09	25	25	150	12,5	CCM.. 12 04..	VRT 10 M4,5x12			T20
SCMCN	2020	K 12	20	20	125	10					
SCMCN	2525	M 12	25	25	150	12,5					

SRGCR

ÜRÜN / PRODUCT



TEKNİK ÇİZİM / TECHNICAL DRAWING

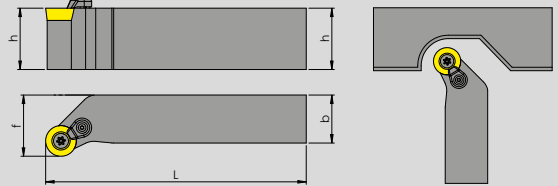

TAKIM KODU ORDERING CODE			KATER ÖLÇÜLERİ DIMENSIONS (mm)				KESİCİ UÇ INSERT	YEDEK PARÇALAR / SPARE PARTS			
								BASKI PARÇASI WEDGE CLAMP	BASKI VİDASI SCREW	ALTLIK VİDASI SHIM SCREW	ANAHTAR TORX KEY
SRGCR/L	2020	K 06	20	20	125	25					
SRGCR/L	2525	M 06	25	25	150	32	RC.. 08	VCP 03	VRT 09 M4x11	VRT 06 M3,5x9	T15
SRGCR/L	2020	K 08	20	20	125	25					
SRGCR/L	2525	M 08	25	25	150	32	RC.. 10	VCP 03	VRT 09 M4x11	VRT 06 M3,5x9	T15
SRGCR/L	2020	K 10	20	20	125	25					
SRGCR/L	2525	M 10	25	25	150	32					
SRGCR/L	3232	P 10	32	32	170	16	RC.. 12	VCP 03	VRT 09 M4x11	VRT 06 M3,5x9	T15
SRGCR/L	2020	K 12	20	20	125	25					
SRGCR/L	2525	M 12	25	25	150	32	RC.. 16	VCP 04	VRT 12 M6x16	VRT 13 M5x12	T20
SRGCR/L	3232	P 12	32	32	170	16					
SRGCR/L	2020	K 16	20	20	125	25					
SRGCR/L	2525	M 16	25	25	150	32	RC.. 16	VCP 04	VRT 12 M6x16	VRT 13 M5x12	T20
SRGCR/L	3232	P 16	32	32	170	16					



P SİSTEM DIŞ TORNA KATERLERİ

P System external
lathe tool holders
www.vorgen.com



TIRTIR DIŞ TORNA KATERLERİ

Inchinemuon clamp
outside diameter



The red power for
the professionals
Profesyoneller için
Kırmızı Güç

PTJNR















ÜRÜN / PRODUCT

93°



TEKNİK ÇİZİM / TECHNICAL DRAWING



TAKIM KODU ORDERING CODE			KATER ÖLÇÜLERİ DIMENSIONS (mm)				KESİCİ UÇ INSERT	YEDEK PARÇALAR / SPARE PARTS					
								BASKI PARÇASI WEDGE CLAMP	BASKI VİDASI SCREW	ALTLIK SHIM	ALTLIK VİDASI SHIM SCREW	YAY SPRING	ANAHTAR ALLEN KEY
PTJNR/L	2020	K 12	20	20	125	25	 TNM.. 22 04..	 VPDP 03	 VPV 03	 VPTN 22	 VAPV 03		 AA3
PTJNR/L	2525	M 22	25	25	150	32							
PTJNR/L	3232	P 22	32	32	170	40							
PTJNR/L	4040	S 22	40	40	200	50							
PTJNR/L	2020	K 16	20	20	125	25	 TNM.. 16 04..	 VPDP 04	 VPV 04	 VPTN 16	 VAPV 04		 AA3
PTJNR/L	2525	M 16	25	25	150	32							
PTJNR/L	3232	P 16	32	32	170	40							

PCLNR





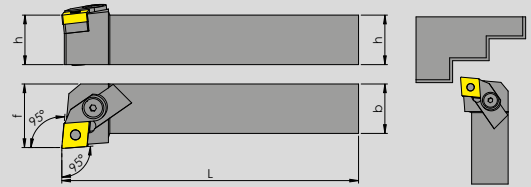

ÜRÜN / PRODUCT

95°



TEKNİK ÇİZİM / TECHNICAL DRAWING



TAKIM KODU ORDERING CODE			KATER ÖLÇÜLERİ DIMENSIONS (mm)				KESİCİ UÇ INSERT	YEDEK PARÇALAR / SPARE PARTS					
								BASKI PARÇASI WEDGE CLAMP	BASKI VİDASI SCREW	ALTLIK SHIM	ALTLIK VİDASI SHIM SCREW	YAY SPRING	ANAHTAR ALLEN KEY
PCLNR/L	2020	K 12	20	20	125	25	 CNM.. 12 04..	 VPDP 02	 VPV 02	 VPCN 12	 VAPV 02		 AA3
PCLNR/L	2525	M 12	25	25	150	32							
PCLNR/L	3232	P 12	32	32	170	40							
PCLNR/L	4040	S 12	40	40	200	50							

TIRTIR

ÜRÜN / PRODUCT



TEKNİK ÇİZİM / TECHNICAL DRAWING

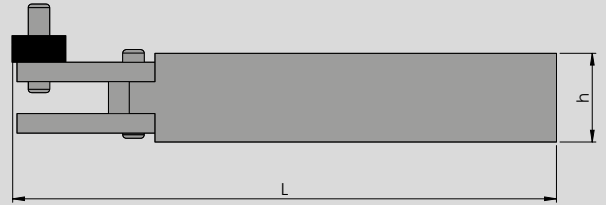

TAKIM KODU ORDERING CODE		KATER ÖLÇÜLERİ DIMENSIONS (mm)				KESİCİ UÇ INSERT	YEDEK PARÇALAR / SPARE PARTS
							PİM / PINTLE
TKCN	25 25 2	h	b	L	f		
		25	25	150	44	20 x 10 x 16	VTP 005

TIRTIR

ÜRÜN / PRODUCT



TEKNİK ÇİZİM / TECHNICAL DRAWING

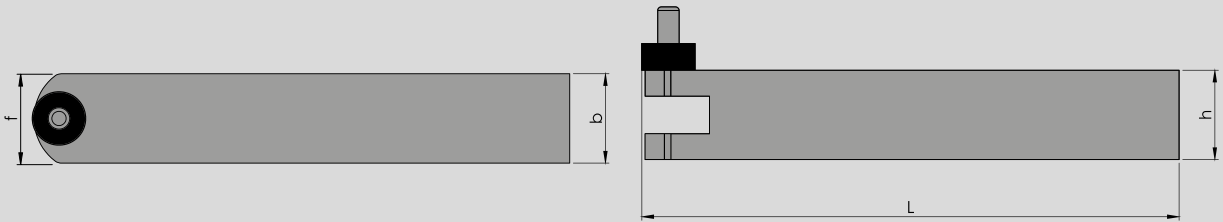

TAKIM KODU ORDERING CODE		KATER ÖLÇÜLERİ DIMENSIONS (mm)				KESİCİ UÇ INSERT	YEDEK PARÇALAR / SPARE PARTS
		h	b	L	f		PİM / PINTLE
TKTN	25 25 1	25	25	150	25		
						20 x 10 x 16	VTP 005



The red power for
the professionals
Profesyoneller için
Kırmızı Güç

VOR



D SİSTEM DELİK
TORNA KATERLERİ
D System boring bars

www.vorgen.com

DD-NR ÜRÜN / PRODUCT 62,5°

TEKNİK ÇİZİM / TECHNICAL DRAWING

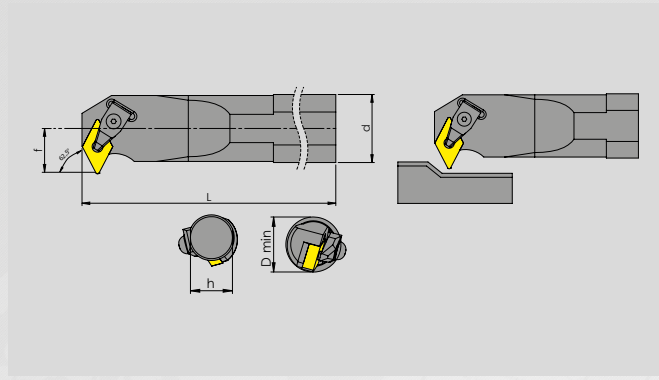

TAKIM KODU ORDERING CODE			KATER ÖLÇÜLERİ DIMENSIONS (mm)					KESİCİ UÇ INSERT	YEDEK PARÇALAR / SPARE PARTS					
									BASKI PARÇASI WEDGE CLAMP	BASKI VİDASI SCREW	ALTLIK SHIM	ALTLIK VİDASI SHIM SCREW	YAY SPRING	ANAHTAR ALLEN KEY
S32T	DD-NR/L	15	d	h	L	f	Dmin							
S40U	DD-NR/L	15	32	30	300	22	44	DNM.. 15 06..	VDP 02	VRV 02 M6	VRDN 15	VAV 02 M5	VRV 01	AA3
S50V	DD-NR/L	15	40	37,5	350	29	52							
			50	47	420	36	67							

DDUNR ÜRÜN / PRODUCT 93°

TEKNİK ÇİZİM / TECHNICAL DRAWING

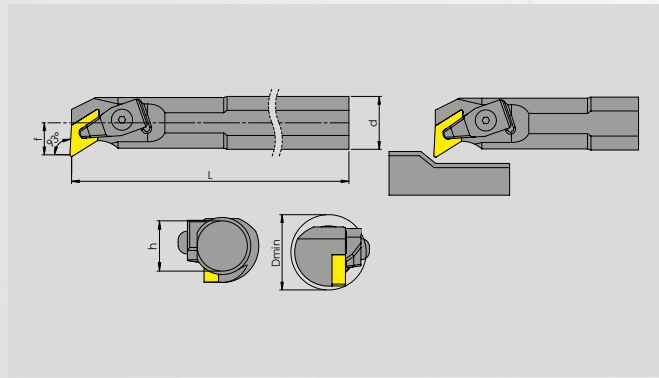

TAKIM KODU ORDERING CODE			KATER ÖLÇÜLERİ DIMENSIONS (mm)					KESİCİ UÇ INSERT	YEDEK PARÇALAR / SPARE PARTS					
									BASKI PARÇASI WEDGE CLAMP	BASKI VİDASI SCREW	ALTLIK SHIM	ALTLIK VİDASI SHIM SCREW	YAY SPRING	ANAHTAR ALLEN KEY
S20R	DDUNR/L	11	d	h	L	f	Dmin							
S25S	DDUNR/L	11	20	18	200	13	25	DNM.. 11 04..	VDP 01	VRV 01 M5			VRV 01	AA3
S25S	DDUNR/L	15	25	23	250	17	32				VRDC 11	VAV 03 M4	VRV 01	AA3
S32T	DDUNR/L	15	32	30	300	22	40	DNM.. 15 06..						
S40U	DDUNR/L	15	40	37,5	350	27	50		VDP 02	VRV 02 M6	VRDN 15	VAV 02 M5	VRV 01	AA3
S50V	DDUNR/L	15	50	47	420	35	63							

DDQNR

ÜRÜN / PRODUCT

107,5°



TEKNİK ÇİZİM / TECHNICAL DRAWING

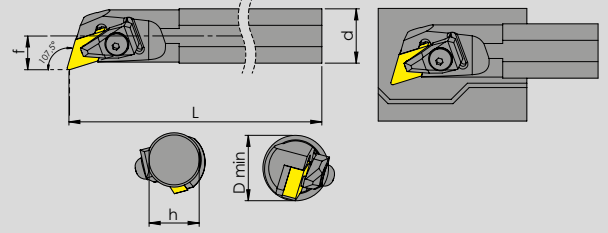

TAKIM KODU ORDERING CODE		KATER ÖLÇÜLERİ DIMENSIONS (mm)						KESİCİ UÇ INSERT	YEDEK PARÇALAR / SPARE PARTS					
		d	h	L	f	Dmin	BASKI PARÇASI WEDGE CLAMP		BASKI VİDASI SCREW	ALTLIK SHIM	ALTLIK VİDASI SHIM SCREW	YAY SPRING	ANAHTAR ALLEN KEY	
S20R	DDQNR/L	11	20	18	200	13	25	DNM.. 11 04..	VDP 01	VRV 01 M5			VRY 01	AA3
S25S	DDQNR/L	11	25	23	250	17	32		VDP 01	VRV 01 M5	VRDC 11	VAV 03 M4	VRY 01	AA3
S25S	DDQNR/L	15	25	23	250	17	32	DNM.. 15 06..						
S32T	DDQNR/L	15	32	30	300	22	40		VDP 02	VRV 02 M6	VRDN 15	VAV 02 M5	VRY 01	AA3
S40U	DDQNR/L	15	40	37	350	27	50							
S50V	DDQNR/L	15	50	47	420	35	63							

DCLNR

ÜRÜN / PRODUCT

95°



TEKNİK ÇİZİM / TECHNICAL DRAWING

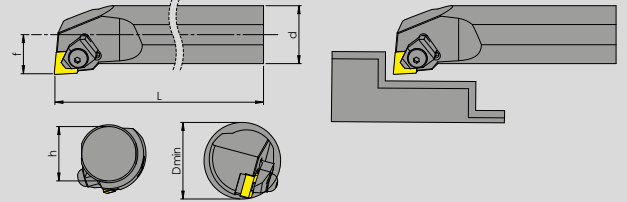

TAKIM KODU ORDERING CODE		KATER ÖLÇÜLERİ DIMENSIONS (mm)						KESİCİ UÇ INSERT	YEDEK PARÇALAR / SPARE PARTS					
		d	h	L	f	Dmin	BASKI PARÇASI WEDGE CLAMP		BASKI VİDASI SCREW	ALTLIK SHIM	ALTLIK VİDASI SHIM SCREW	YAY SPRING	ANAHTAR ALLEN KEY	
S20R	DCLNR/L	12	20	18	200	13	25	CNM.. 12 04..	VDP 02	VRV 01 M6			VRY 01	AA3
S25S	DCLNR/L	12	25	23	250	17	32							
S32T	DCLNR/L	12	32	30	300	22	40	CNM.. 12 04..	VDP 02	VRV 02 M6	VRCN 12	VAV 02 M5	VRY 01	AA3
S40U	DCLNR/L	12	40	37	350	27	50							
S50V	DCLNR/L	12	50	47	420	35	63							
S32T	DCLNR/L	16	32	30	300	22	40	CNM.. 16 06..						
S40U	DCLNR/L	16	40	37	350	27	50		VDP 04	VRV 03 M6	VRCN 16	VAV 04 M5	VRY 02	AA4
S50V	DCLNR/L	16	50	47	420	35	63							
S40U	DCLNR/L	19	40	37	350	27	50	CNM.. 19 06..						
S50V	DCLNR/L	19	50	47	420	35	63		VDP 05	VRV 03 M6	VRCN 19	VAV 05 M6	VRY 02	AA4

DSKNR ÜRÜN / PRODUCT 75°

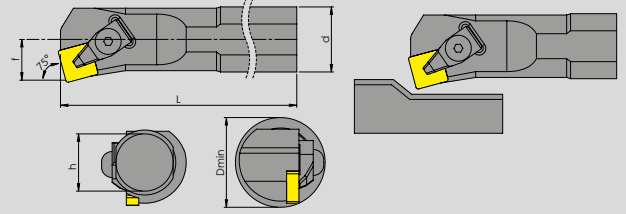
TEKNİK ÇİZİM / TECHNICAL DRAWING

TAKIM KODU ORDERING CODE			KATER ÖLÇÜLERİ DIMENSIONS (mm)					KESİCİ UÇ INSERT	YEDEK PARÇALAR / SPARE PARTS					
									BASKI PARÇASI WEDGE CLAMP	BASKI VİDASI SCREW	ALTLIK SHIM	ALTLIK VİDASI SHIM SCREW	YAY SPRING	ANAHTAR ALLEN KEY
S25S	DSKNR/L	12	d	h	L	f	Dmin							
S32T	DSKNR/L	12	25	23	250	17	32	SNM.. 12 04..	VDP 02	VRV 02 M6	VRSN 12	VAV 02 M5	VRY 01	AA3
S40U	DSKNR/L	12	32	30	300	22	40							
			40	37	350	27	50							

DVQNR ÜRÜN / PRODUCT 107,5°

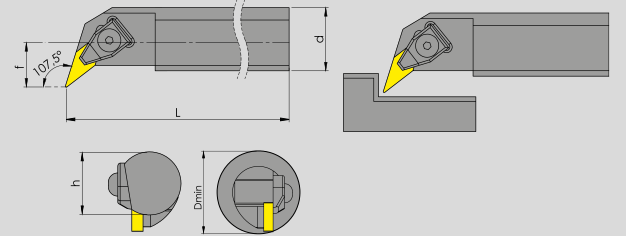
TEKNİK ÇİZİM / TECHNICAL DRAWING

TAKIM KODU ORDERING CODE			KATER ÖLÇÜLERİ DIMENSIONS (mm)					KESİCİ UÇ INSERT	YEDEK PARÇALAR / SPARE PARTS					
									BASKI PARÇASI WEDGE CLAMP	BASKI VİDASI SCREW	ALTLIK SHIM	ALTLIK VİDASI SHIM SCREW	YAY SPRING	ANAHTAR ALLEN KEY
S25S	DVQNR/L	16	d	h	L	f	Dmin							
S32T	DVQNR/L	16	25	23	250	20	32	VNM.. 16 04..	VDP 03	VRV 02 M6	VRVB 16	VAV 11	VRY 01	AA3
S40U	DVQNR/L	16	32	30	300	22	40							
			40	37,5	350	27	50							

DWLNR







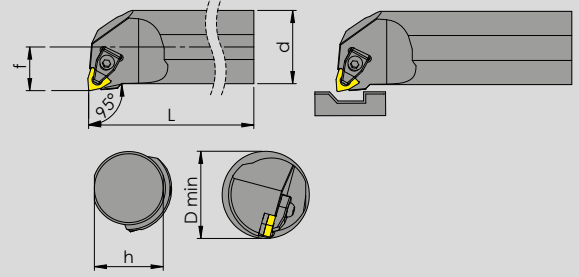

ÜRÜN / PRODUCT

95°



TEKNİK ÇİZİM / TECHNICAL DRAWING



TAKIM KODU ORDERING CODE			KATER ÖLÇÜLERİ DIMENSIONS (mm)					KESİCİ UÇ INSERT	YEDEK PARÇALAR / SPARE PARTS											
									BASKI PARÇASI WEDGE CLAMP	BASKI VİDASI SCREW	ALTLIK SHIM	ALTLIK VİDASI SHIM SCREW	YAY SPRING	ANAHTAR ALLEN KEY						
S20R	DWLNR/L	06	20	18	200	13	25	WNM.. 06 T3..												
S25S	DWLNR/L	06	25	23	250	17	32		VDP 01	VRV 01 M5	VRWN 06	VAV 03 M4	VRV 01	AA3						
S32T	DWLNR/L	06	32	30	300	22	40													
S25S	DWLNR/L	08	25	23	250	17	32	WNM.. 08 04..												
S32T	DWLNR/L	08	32	30	300	22	40								VDP 02	VRV 02 M6	VRWN 08	VAV 02 M5	VRV 01	AA3
S40U	DWLNR/L	08	40	37	350	27	50													
S50V	DWLNR/L	08	50	47	420	35	63													

DTUNR









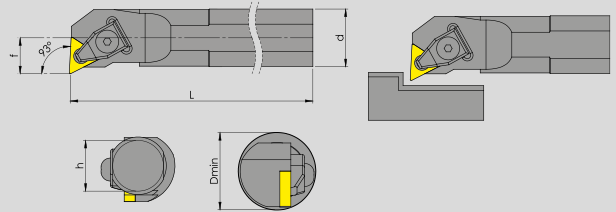

ÜRÜN / PRODUCT

93°



TEKNİK ÇİZİM / TECHNICAL DRAWING



TAKIM KODU ORDERING CODE			KATER ÖLÇÜLERİ DIMENSIONS (mm)					KESİCİ UÇ INSERT	YEDEK PARÇALAR / SPARE PARTS											
									BASKI PARÇASI WEDGE CLAMP	BASKI VİDASI SCREW	ALTLIK SHIM	ALTLIK VİDASI SHIM SCREW	YAY SPRING	ANAHTAR ALLEN KEY						
S25S	DTUNR/L	16	25	23	250	17	32	TNM.. 16 04..												
S32T	DTUNR/L	16	32	30	300	22	40								VDP 01	VRV 01 M5	VRTN 16	VAV 02 M5	VRV 01	AA3
S40U	DTUNR/L	16	40	37	350	27	50													
S25S	DTUNR/L	22	25	23	250	17	32	TNM.. 22 04..												
S32T	DTUNR/L	22	32	30	300	22	40								VDP 02	VRV 02 M6	VRTN 22	VAV 02 M5	VRV 01	AA3
S40U	DTUNR/L	22	40	37	350	27	50													
S50V	DTUNR/L	22	50	47	420	35	63													

DVUNR
ÜRÜN / PRODUCT
93°

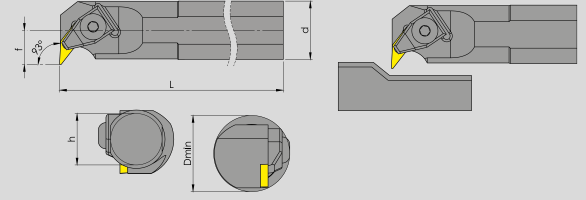
TEKNİK ÇİZİM / TECHNICAL DRAWING

TAKIM KODU ORDERING CODE		KATER ÖLÇÜLERİ DIMENSIONS (mm)						KESİCİ UÇ INSERT	YEDEK PARÇALAR / SPARE PARTS					
		d	h	L	f	Dmin	BASKI PARÇASI WEDGE CLAMP		BASKI VİDASI SCREW	ALTLIK SHIM	ALTLIK VİDASI SHIM SCREW	YAY SPRING	ANAHTAR ALLEN KEY	
S25S	DVUNR/L	16	25	23	250	20	32	 VNM.. 16 04..						
S32T	DVUNR/L	16	32	30	300	22	40		VDP 03	VRV 02 M6	VRVB 16	VAV 02 M5	VRY 01	AA3
S40U	DVUNR/L	16	40	37,5	350	27	50							





The red power for
the professionals
Profesyoneller için
Kırmızı Güç

M SİSTEM DELİK
TORNA KATERLERİ
M System boring bars

www.vorgen.com

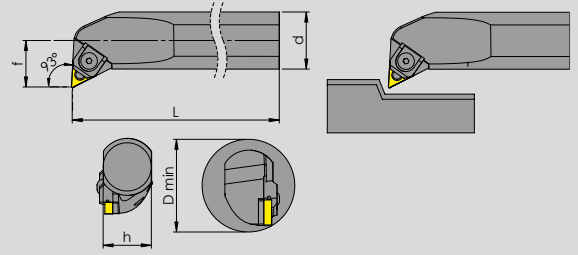

MTUNR
ÜRÜN / PRODUCT
93°

TEKNİK ÇİZİM / TECHNICAL DRAWING

TAKIM KODU ORDERING CODE			KATER ÖLÇÜLERİ DIMENSIONS (mm)					KESİCİ UÇ INSERT	YEDEK PARÇALAR / SPARE PARTS					
									BASKI PARÇASI WEDGE CLAMP	BASKI VİDASI SCREW	ALTLIK SHIM	ALTLIK VİDASI SHIM SCREW	YAY SPRING	ANAHTAR ALLEN KEY
S20R	MTUNR/L	16	20	18	200	13	25	TNM.. 16 04..	VMP 03	VRV 01 M5			VRV 01	AA3
S25S	MTUNR/L	16	25	23	250	17	32		VMP 03	VRV 01 M5	VRTN 16	VAV 08 M5	VRV 01	AA3
S32T	MTUNR/L	16	32	30	300	22	40		VMP 03	VRV 01 M5	VRTN 16	VAV 08 M5	VRV 01	AA3
S40U	MTUNR/L	16	40	37	350	27	50		VMP 03	VRV 01 M5	VRTN 16	VAV 08 M5	VRV 01	AA3
S25S	MTUNR/L	22	25	23	250	17	32	TNM.. 22 04..	VMP 04	VRV 02 M6	VRTN 22	VAV 10 M6	VRV 01	AA3
S32T	MTUNR/L	22	32	30	300	22	40		VMP 04	VRV 02 M6	VRTN 22	VAV 10 M6	VRV 01	AA3
S40U	MTUNR/L	22	40	37	350	27	50		VMP 04	VRV 02 M6	VRTN 22	VAV 10 M6	VRV 01	AA3
S50V	MTUNR/L	22	50	47	420	35	63		VMP 04	VRV 02 M6	VRTN 22	VAV 10 M6	VRV 01	AA3
S50V	MTUNR/L	22	50	47	420	35	63		VMP 04	VRV 02 M6	VRTN 22	VAV 10 M6	VRV 01	AA3

MT-NR
ÜRÜN / PRODUCT
60°

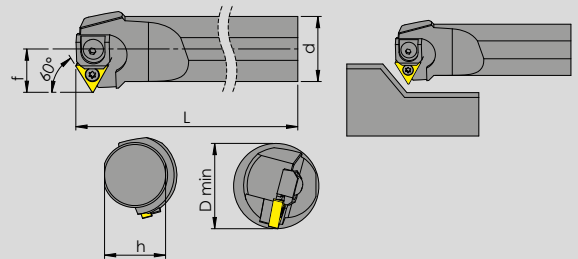
TEKNİK ÇİZİM / TECHNICAL DRAWING

TAKIM KODU ORDERING CODE			KATER ÖLÇÜLERİ DIMENSIONS (mm)					KESİCİ UÇ INSERT	YEDEK PARÇALAR / SPARE PARTS					
									BASKI PARÇASI WEDGE CLAMP	BASKI VİDASI SCREW	ALTLIK SHIM	ALTLIK VİDASI SHIM SCREW	YAY SPRING	ANAHTAR ALLEN KEY
S25S	MT-NR/L	16	25	23	250	17	32	TNM.. 16 04..	VMP 03	VRV 01 M5	VRTN 16	VAV 08 M5	VRV 01	AA3
S32T	MT-NR/L	16	32	30	300	22	40		VMP 03	VRV 01 M5	VRTN 16	VAV 08 M5	VRV 01	AA3
S32T	MT-NR/L	22	32	30	300	22	40		VMP 03	VRV 01 M5	VRTN 16	VAV 08 M5	VRV 01	AA3
S40U	MT-NR/L	22	40	37	350	27	50	TNM.. 22 04..	VMP 04	VRV 02 M6	VRTN 22	VAV 10 M6	VRV 01	AA3
S50V	MT-NR/L	22	50	47	420	35	63		VMP 04	VRV 02 M6	VRTN 22	VAV 10 M6	VRV 01	AA3

MTQNR

ÜRÜN / PRODUCT

107,5°



TEKNİK ÇİZİM / TECHNICAL DRAWING

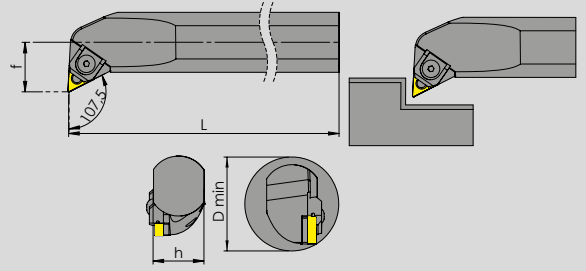

TAKIM KODU ORDERING CODE			KATER ÖLÇÜLERİ DIMENSIONS (mm)					KESİCİ UÇ INSERT	YEDEK PARÇALAR / SPARE PARTS					
									BASKI PARÇASI WEDGE CLAMP	BASKI VİDASI SCREW	ALTLIK SHIM	ALTLIK VİDASI SHIM SCREW	YAY SPRING	ANAHTAR ALLEN KEY
S20R	MTQNR/L	16	20	18	200	13	25	TNM.. 16 04..	VMP 03	VRV 01 M5			VRV 01	AA3
S25S	MTQNR/L	16	25	23	250	17	32		VMP 03	VRV 01 M5	VRTN 16	VAV 08 M5	VRV 01	AA3
S32T	MTQNR/L	16	32	30	300	22	40							
S40U	MTQNR/L	16	40	37	350	27	50							
S25S	MTQNR/L	22	25	23	250	17	32	TNM.. 22 04..	VMP 04	VRV 02 M6	VRTN 22	VAV 10 M6	VRV 01	AA3
S32T	MTQNR/L	22	32	30	300	22	40							
S40U	MTQNR/L	22	40	37	350	27	50							
S50V	MTQNR/L	22	50	47	420	35	63							

MWLN

ÜRÜN / PRODUCT

95°



TEKNİK ÇİZİM / TECHNICAL DRAWING

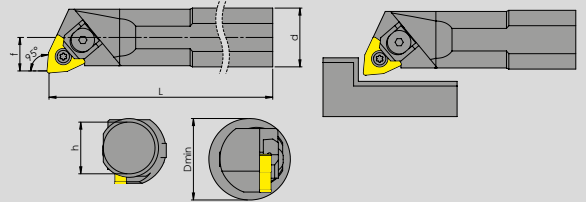

TAKIM KODU ORDERING CODE			KATER ÖLÇÜLERİ DIMENSIONS (mm)					KESİCİ UÇ INSERT	YEDEK PARÇALAR / SPARE PARTS					
									BASKI PARÇASI WEDGE CLAMP	BASKI VİDASI SCREW	ALTLIK SHIM	ALTLIK VİDASI SHIM SCREW	YAY SPRING	ANAHTAR ALLEN KEY
S20R	MWLN/L	06	20	18	200	13	25	WNM.. 06 T3..	VMP 01	VRV 01 M5	VRWN 06	VAV 08 M5	VRV 01	AA3
S25S	MWLN/L	06	25	23	250	17	32							
S32T	MWLN/L	06	32	30	300	22	40							
S20R	MWLN/L	08	20	18	200	13	25	WNM.. 08 04..	VMP 02	VRV 02 M6			VRV 01	AA3
S25S	MWLN/L	08	25	23	250	17	32							
S32T	MWLN/L	08	32	30	300	22	40		VMP 02	VRV 02 M6	VRWN 08	VAV 10 M6	VRV 01	AA3
S40U	MWLN/L	08	40	37	350	27	50							
S50V	MWLN/L	08	50	47	420	35	63							

MTFNR
ÜRÜN / PRODUCT
90°

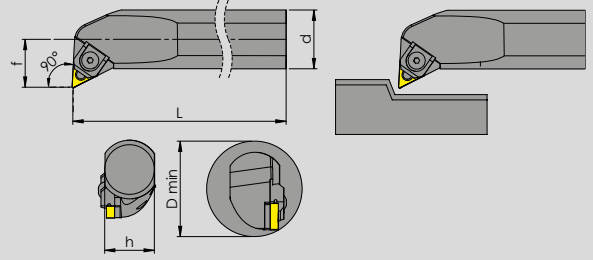
TEKNİK ÇİZİM / TECHNICAL DRAWING

TAKIM KODU ORDERING CODE		KATER ÖLÇÜLERİ DIMENSIONS (mm)						KESİCİ UÇ INSERT	YEDEK PARÇALAR / SPARE PARTS					
		d	h	L	f	Dmin	BASKI PARÇASI WEDGE CLAMP		BASKI VIDASI SCREW	ALTLIK SHIM	ALTLIK VIDASI SHIM SCREW	YAY SPRING	ANAHTAR ALLEN KEY	
S20R	MTFNR/L	16	20	18	200	13	25		VMP 03	VRV 01 M5			VRV 01	AA3
S25S	MTFNR/L	16	25	23	250	17	32	TNM.. 16 04..	VMP 03	VRV 01 M5	VRTN 16	VAV 08 M5	VRV 01	AA3
S32T	MTFNR/L	16	32	30	300	22	40							
S40U	MTFNR/L	16	40	37	350	27	50							
S25S	MTFNR/L	22	25	23	250	17	32	TNM.. 22 04..	VMP 04	VRV 02 M6	VRTN 22	VAV 10 M6	VRV 01	AA3
S32T	MTFNR/L	22	32	30	300	22	40							
S40U	MTFNR/L	22	40	37	350	27	50							
S50V	MTFNR/L	22	50	47	420	35	63							





The red power for
the professionals
Profesyoneller için
Kırmızı Güç



C SİSTEM DELİK
TORNA KATERLERİ
C System boring bars

www.vorgen.com

CKUNR

ÜRÜN / PRODUCT

93°



TEKNİK ÇİZİM / TECHNICAL DRAWING

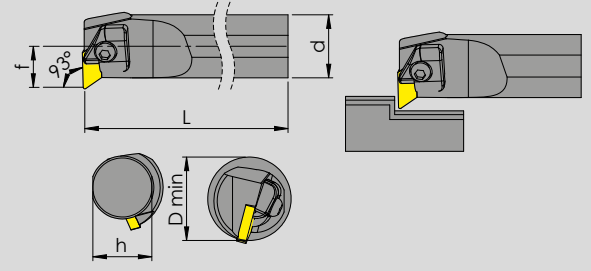

TAKIM KODU ORDERING CODE		KATER ÖLÇÜLERİ DIMENSIONS (mm)						KESİCİ UÇ INSERT	YEDEK PARÇALAR / SPARE PARTS					
		d	h	L	f	Dmin	BASKI PARÇASI WEDGE CLAMP		BASKI VİDASI SCREW	ALTLIK SHIM	ALTLIK VİDASI SHIM SCREW	YAY SPRING	ANAHTAR ALLEN KEY	
S25S	CKUNR/L	16	25	23	250	19	38	 KNUX.. 16 R/L	 VCP 01	 VRV 04 M6	 VRKN 16 R/L	 VAV 01 M3	 VRY 02	 AA4
S28T	CKUNR/L	16	28	26	290	19	38							
S32T	CKUNR/L	16	32	30	330	22	40							
S40U	CKUNR/L	16	40	37	400	27	50							
S45V	CKUNR/L	16	45	42	400	29	52							
S50V	CKUNR/L	16	50	47	420	35	63							

CTFPR

ÜRÜN / PRODUCT

91°



TEKNİK ÇİZİM / TECHNICAL DRAWING

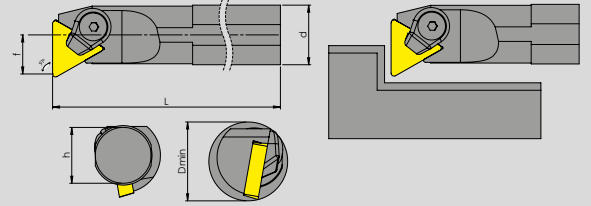

TAKIM KODU ORDERING CODE		KATER ÖLÇÜLERİ DIMENSIONS (mm)						KESİCİ UÇ INSERT	YEDEK PARÇALAR / SPARE PARTS					
		d	h	L	f	Dmin	BASKI PARÇASI WEDGE CLAMP		BASKI VİDASI SCREW	ALTLIK SHIM	ALTLIK VİDASI SHIM SCREW	YAY SPRING	ANAHTAR TORX KEY	
S12Q	CTFPR/L	11	12	11	125	9	16	 TP. 11 03..	 VCP 01	 VRT 09 M4x11	 TP. 16 03..	 VAV 02 M5	 VRY 02	 T15
S16R	CTFPR/L	16	16	15	180	11	20							
S20R	CTFPR/L	16	20	18	190	13	25	 TP. 16 03..	 VCP 03	 VRT 09 M4x11	 VRTP 22	 VAV 02 M5	 VRY 02	 T15
S25S	CTFPR/L	16	25	23	250	17	32							
S25S	CTFPR/L	22	25	23	250	17	32	 TP. 22 04..	 VCP 03	 VRT12 M6x16	 VRTP 22	 VAV 02 M5	 VRY 02	 T20
S32T	CTFPR/L	22	32	30	300	27	40							



S SİSTEM DELİK
TORNA KATERLERİ
S System boring bars

www.vorgen.com



The red power for
the professionals
Profesyoneller için
Kırmızı Güç

SDUCR

ÜRÜN / PRODUCT

93°



TEKNİK ÇİZİM / TECHNICAL DRAWING

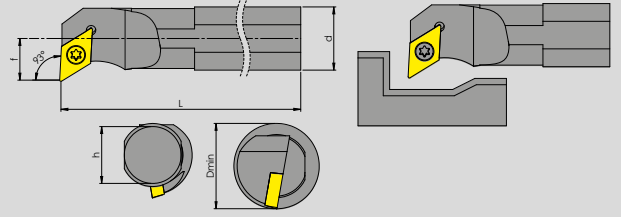

TAKIM KODU ORDERING CODE			KATER ÖLÇÜLERİ DIMENSIONS (mm)					KESİCİ UÇ INSERT	YEDEK PARÇALAR / SPARE PARTS			
									BASKI VİDASI SCREW	ALTLIK SHIM	ALTLIK VİDASI SHIM SCREW	ANAHTAR TORX KEY
			d	h	L	f	Dmin					
S10J	SDUCR/L	07	10	9	120	7	13	DCM.. 07 02..	VRT 04 M2,5x7			T08
S12K	SDUCR/L	07	12	11	125	9	16					
S10-16M	SDUCR/L	07	10-16	15	150	6	14					
S12-16M	SDUCR/L	07	12-16	15	150	8	16					
S16Q	SDUCR/L	07	16	15	180	11	20	DCM.. 11 T3..	VRT 06 M3,5x9			T15
S16Q	SDUCR/L	11	16	15	180	11	20					
S20R	SDUCR/L	11	20	18	200	13	25	DCM.. 11 T3..	VRT 06 M3,5x9			T15
S25S	SDUCR/L	11	25	23	250	17	32	DCM.. 11 T3..	VRT 06 M3,5x9			T15
S32T	SDUCR/L	11	32	30	300	22	40	DCM.. 11 T3..	VRT 06 M3,5x9	VRDC 11	VAV 06 M5.05	T15

SDQCR

ÜRÜN / PRODUCT

107,5°



TEKNİK ÇİZİM / TECHNICAL DRAWING

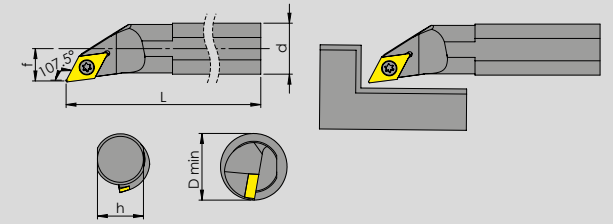

TAKIM KODU ORDERING CODE			KATER ÖLÇÜLERİ DIMENSIONS (mm)					KESİCİ UÇ INSERT	YEDEK PARÇALAR / SPARE PARTS			
									BASKI VİDASI SCREW	ALTLIK SHIM	ALTLIK VİDASI SHIM SCREW	ANAHTAR TORX KEY
			d	h	L	f	Dmin					
S10J	SDQCR/L	07	10	9	120	7	13	DCM.. 07 02..	VRT 04 M2,5x7			T08
S12K	SDQCR/L	07	12	11	125	9	16					
S16Q	SDQCR/L	07	16	15	180	11	20					
S16Q	SDQCR/L	11	16	15	180	11	20					
S20R	SDQCR/L	11	20	18	200	13	25	DCM.. 11 T3..	VRT 06 M3,5x9			T15
S25S	SDQCR/L	11	25	23	250	17	32	DCM.. 11 T3..	VRT 06 M3,5x9			T15
S32T	SDQCR/L	11	32	30	300	22	40	DCM.. 11 T3..	VRT 06 M3,5x9	VRDC 11	VAV 06 M5.05	T15

SD-CR





ÜRÜN / PRODUCT

62,5°

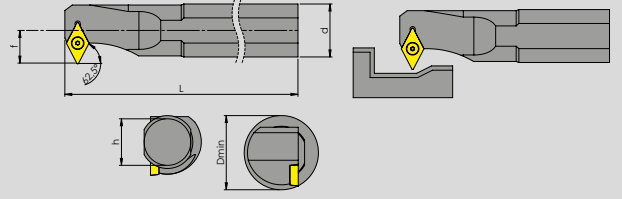

TEKNİK ÇİZİM / TECHNICAL DRAWING



TAKIM KODU ORDERING CODE			KATER ÖLÇÜLERİ DIMENSIONS (mm)					KESİCİ UÇ INSERT	YEDEK PARÇALAR / SPARE PARTS			
									BASKI VİDASI SCREW	ALTLIK SHIM	ALTLIK VİDASI SHIM SCREW	ANAHTAR TORX KEY
			d	h	L	f	Dmin					
S10J	SD-CR/L	07	10	9	120	7	13	DCM.. 07 02..	VRT 04 M2,5x7			T08
S12K	SD-CR/L	07	12	11	125	9	16					
S16Q	SD-CR/L	07	16	15	180	11	20					
S16Q	SD-CR/L	11	16	15	180	11	20	DCM.. 11 T3..	VRT 06 M3,5x9			T15
S20R	SD-CR/L	11	20	18	200	13	25					
S25S	SD-CR/L	11	25	23	250	17	32	DCM.. 11 T3..	VRT 06 M3,5x9			T15
S32T	SD-CR/L	11	32	30	300	22	40	DCM.. 11 T3..	VRT 06 M3,5x9	VRDC 11	VAV 06 M5.05	T15

SDZCR





ÜRÜN / PRODUCT

93°

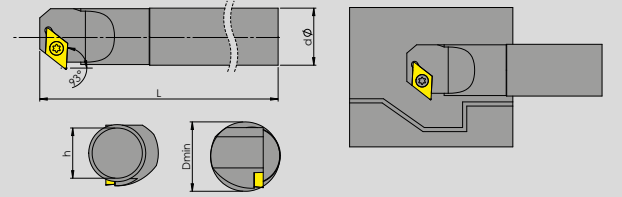

TEKNİK ÇİZİM / TECHNICAL DRAWING



TAKIM KODU ORDERING CODE			KATER ÖLÇÜLERİ DIMENSIONS (mm)					KESİCİ UÇ INSERT	YEDEK PARÇALAR / SPARE PARTS			
									BASKI VİDASI SCREW	ALTLIK SHIM	ALTLIK VİDASI SHIM SCREW	ANAHTAR TORX KEY
			d	h	L	f	Dmin					
S12K	SDZCR/L	07	12	11	125	9	16	DCM.. 07 02..	VRT 04 M2,5x7			T08
S16Q	SDZCR/L	07	16	15	180	11	20					
S16Q	SDZCR/L	11	16	15	180	11	20					
S20R	SDZCR/L	11	20	18	200	13	25	DCM.. 11 T3..	VRT 06 M3,5x9			T15
S25S	SDZCR/L	11	25	23	250	17	32					
S32T	SDZCR/L	11	32	30	300	22	40	DCM.. 11 T3..	VRT 06 M3,5x9	VRDC 11	VAV 06 M5.05	T15

SDXCR

ÜRÜN / PRODUCT

117,5°



TEKNİK ÇİZİM / TECHNICAL DRAWING

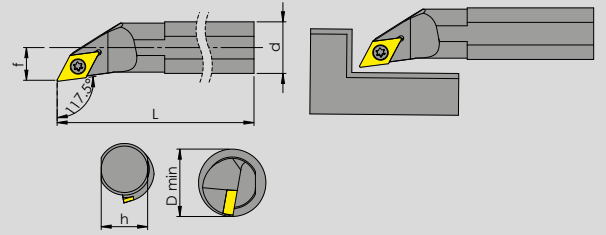

TAKIM KODU ORDERING CODE			KATER ÖLÇÜLERİ DIMENSIONS (mm)					KESİCİ UÇ INSERT	YEDEK PARÇALAR / SPARE PARTS			
									BASKI VİDASI SCREW	ALTLIK SHIM	ALTLIK VİDASI SHIM SCREW	ANAHTAR TORX KEY
			d	h	L	f	Dmin					
S12K	SDXCR/L	07	12	11	125	9	16	DCM.. 07 02..	VRT 04 M2,5x7			T08
S16Q	SDXCR/L	07	16	15	180	11	20	DCM.. 11 T3..	VRT 06 M3,5x9			T15
S16Q	SDXCR/L	11	16	15	180	11	20					
S20R	SDXCR/L	11	20	18	200	13	25					
S25S	SDXCR/L	11	25	23	250	17	32	DCM.. 11 T3..	VRT 06 M3,5x9			T15
S32T	SDXCR/L	11	32	30	300	22	40	DCM.. 11 T3..	VRT 06 M3,5x9	VRDC 11	VAV 06 M5.05	T15

STUPR

ÜRÜN / PRODUCT

93°



TEKNİK ÇİZİM / TECHNICAL DRAWING

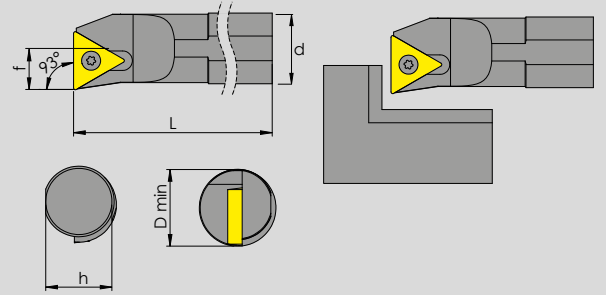

TAKIM KODU ORDERING CODE			KATER ÖLÇÜLERİ DIMENSIONS (mm)					KESİCİ UÇ INSERT	YEDEK PARÇALAR / SPARE PARTS			
									BASKI VİDASI SCREW	ALTLIK SHIM	ALTLIK VİDASI SHIM SCREW	ANAHTAR TORX KEY
			d	h	L	f	Dmin					
S10J	STUPR/L	11	10	9	120	7	13	TPM.. 11 03..	VRT 05 M3x8			T10
S12K	STUPR/L	11	12	11	125	9	16					
S16Q	STUPR/L	11	16	15	180	11	20					
S20R	STUPR/L	11	20	18	200	13	25					



SVUBR









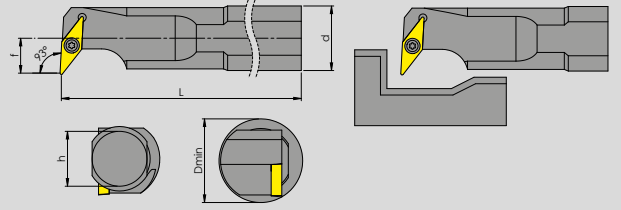

ÜRÜN / PRODUCT

93°



TEKNİK ÇİZİM / TECHNICAL DRAWING



TAKIM KODU ORDERING CODE			KATER ÖLÇÜLERİ DIMENSIONS (mm)					KESİCİ UÇ INSERT	YEDEK PARÇALAR / SPARE PARTS							
									BASKI VİDASI SCREW	ALTLIK SHIM	ALTLIK VİDASI SHIM SCREW	ANAHTAR TORX KEY				
S16Q	SVUBR/L	11	d	h	L	f	Dmin	 VBM.. 11 03..	 VRT 04 M2,5x7		 VAV 06 M5.05	 T08				
S20R	SVUBR/L	11	20	15	180	11	20									
S25S	SVUBR/L	16	25	18	200	13	25	 VBM.. 16 04..	 VRT 07 M3,5x11	 VRVB 16	 VAV 06 M5.05	 T15				
S32T	SVUBR/L	16	32	23	250	17	32									
S40V	SVUBR/L	16	40	23	300	22	40									
S40V	SVUBR/L	16	40	37	350	27	50									

SVUCR









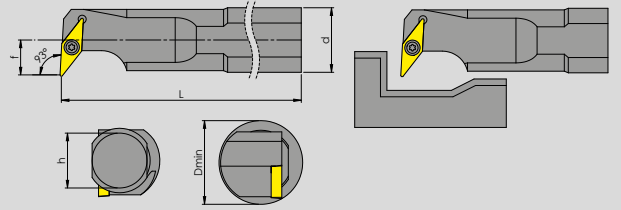

ÜRÜN / PRODUCT

93°



TEKNİK ÇİZİM / TECHNICAL DRAWING



TAKIM KODU ORDERING CODE			KATER ÖLÇÜLERİ DIMENSIONS (mm)					KESİCİ UÇ INSERT	YEDEK PARÇALAR / SPARE PARTS							
									BASKI VİDASI SCREW	ALTLIK SHIM	ALTLIK VİDASI SHIM SCREW	ANAHTAR TORX KEY				
S16Q	SVUCR/L	11	d	h	L	f	Dmin	 VCM.. 11 03..	 VRT 04 M2,5x7		 VAV 06 M5.05	 T08				
S20R	SVUCR/L	11	20	15	180	11	20									
S25S	SVUCR/L	16	25	18	200	13	25	 VCM.. 16 04..	 VRT 07 M3,5x11	 VRVB 16	 VAV 06 M5.05	 T15				
S32T	SVUCR/L	16	32	23	250	17	32									
S40V	SVUCR/L	16	40	23	300	22	40									
S40V	SVUCR/L	16	40	37	350	27	50									

SVQBR
ÜRÜN / PRODUCT
107,5°

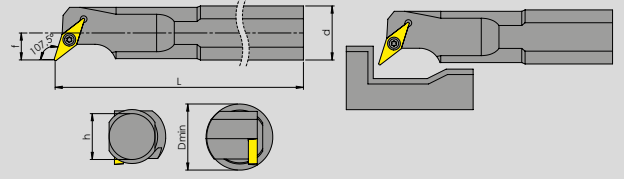
TEKNİK ÇİZİM / TECHNICAL DRAWING

TAKIM KODU ORDERING CODE			KATER ÖLÇÜLERİ DIMENSIONS (mm)					KESİCİ UÇ INSERT	YEDEK PARÇALAR / SPARE PARTS			
									BASKI VİDASI SCREW	ALTLIK SHIM	ALTLIK VİDASI SHIM SCREW	ANAHTAR TORX KEY
			d	h	L	f	Dmin					
S16Q	SVQBR/L	11	16	15	180	11	20	VBM.. 11 03..	VRT 04 M2,5x7			T08
S20R	SVQBR/L	11	20	18	200	13	25					
S25S	SVQBR/L	16	25	23	250	17	32					
S32T	SVQBR/L	16	32	30	300	22	40	VBM.. 16 04..	VRT 07 M3,5x11	VRVB 16	VAV 06 M5.05	T15
S40V	SVQBR/L	16	40	37	350	27	50					

SVQCR
ÜRÜN / PRODUCT
107,5°

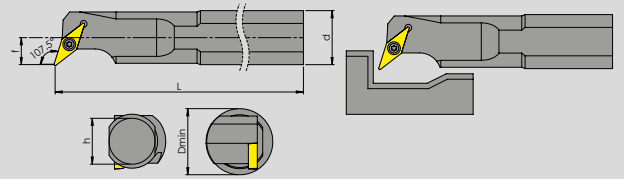
TEKNİK ÇİZİM / TECHNICAL DRAWING

TAKIM KODU ORDERING CODE			KATER ÖLÇÜLERİ DIMENSIONS (mm)					KESİCİ UÇ INSERT	YEDEK PARÇALAR / SPARE PARTS			
									BASKI VİDASI SCREW	ALTLIK SHIM	ALTLIK VİDASI SHIM SCREW	ANAHTAR TORX KEY
			d	h	L	f	Dmin					
S16Q	SVQCR/L	11	16	15	180	11	20	VCM.. 11 03..	VRT 04 M2,5x7			T08
S20R	SVQCR/L	11	20	18	200	13	25					
S25S	SVQCR/L	16	25	23	250	17	32					
S32T	SVQCR/L	16	32	30	300	22	40	VCM.. 16 04..	VRT 07 M3,5x11	VRVB 16	VAV 06 M5.05	T15
S40V	SVQCR/L	16	40	37	350	27	50					



STFCR





ÜRÜN / PRODUCT

90°

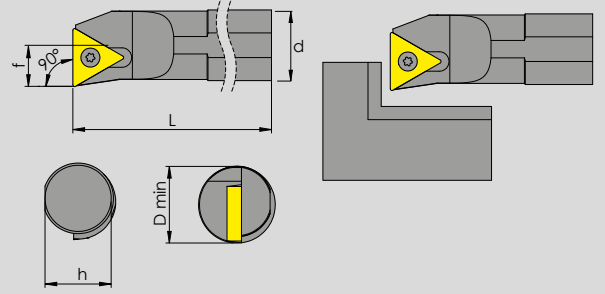

TEKNİK ÇİZİM / TECHNICAL DRAWING



TAKIM KODU ORDERING CODE			KATER ÖLÇÜLERİ DIMENSIONS (mm)					KESİCİ UÇ INSERT	YEDEK PARÇALAR / SPARE PARTS			
									BASKI VİDASI SCREW	ALTLIK SHIM	ALTLIK VİDASI SHIM SCREW	ANAHTAR TORX KEY
			d	h	L	f	Dmin					
S08H	STFCR/L	09	08	7	115	6	11	TCM.. 09 02	VRT 02 M2,2x5			T06
S10J	STFCR/L	09	10	9	120	7	13					
S12K	STFCR/L	09	12	11	125	9	16					
S12K	STFCR/L	11	12	11	125	9	16	TCM.. 11 T3..	VRT 04 M2,5x7			T08
S16Q	STFCR/L	11	16	15	180	11	20					
S20R	STFCR/L	11	20	18	200	13	25	TCM.. 16T3..	VRT 06 M3,5x9			T15
S16Q	STFCR/L	16	16	15	180	11	20					
S20R	STFCR/L	16	20	18	200	13	25					
S25S	STFCR/L	16	25	23	250	17	32					
S32T	STFCR/L	16	32	30	300	22	40	TCM.. 16T3..	VRT 08 M3,5x16	VRTC 16	VAV 06 M5.05	T15

ST-CR



ÜRÜN / PRODUCT

60°

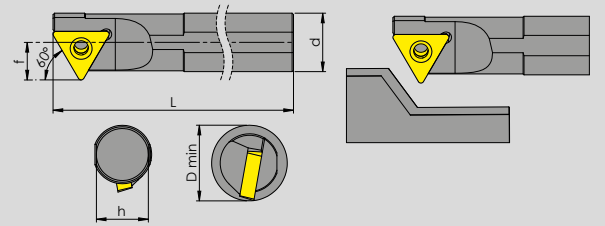

TEKNİK ÇİZİM / TECHNICAL DRAWING



TAKIM KODU ORDERING CODE			KATER ÖLÇÜLERİ DIMENSIONS (mm)					KESİCİ UÇ INSERT	YEDEK PARÇALAR / SPARE PARTS			
									BASKI VİDASI SCREW	ALTLIK SHIM	ALTLIK VİDASI SHIM SCREW	ANAHTAR TORX KEY
			d	h	L	f	Dmin					
S16Q	ST-CR/L	11	16	15	180	11	20	TCM.. 11 T3..	VRT 04 M2,5x7			T08
S20R	ST-CR/L	11	20	18	200	13	25					
S16Q	ST-CR/L	16	16	15	180	11	20	TCM.. 16 T3..	VRT 03 M3,5x9			T15
S20R	ST-CR/L	16	20	18	200	13	25					
S25S	ST-CR/L	16	25	23	250	17	32					
S32T	ST-CR/L	16	32	30	300	22	40					
			d	h	L	f	Dmin	TCM.. 16 T3..	VRT 08 M3,5x16	VRTC 16	VAV 06 M5.05	T15

SVZBR
ÜRÜN / PRODUCT
93°

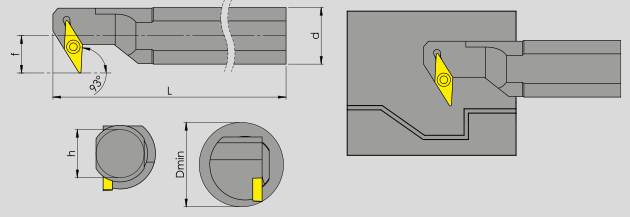
TEKNİK ÇİZİM / TECHNICAL DRAWING

TAKIM KODU ORDERING CODE			KATER ÖLÇÜLERİ DIMENSIONS (mm)					KESİCİ UÇ INSERT	YEDEK PARÇALAR / SPARE PARTS			
									BASKI VİDASI SCREW	ALTLIK SHIM	ALTLIK VİDASI SHIM SCREW	ANAHTAR TORX KEY
			d	h	L	f	Dmin					
S25S	SVZBR/L	16	25	23	250	17	32	VBM.. 16 04..	VRT 08 M3,5x16	VRVB 16	VAV 06 M5.05	T15
S32T	SVZBR/L	16	32	30	300	22	40					
S40U	SVZBR/L	16	40	37	350	27	50					

SCLCR
ÜRÜN / PRODUCT
95°

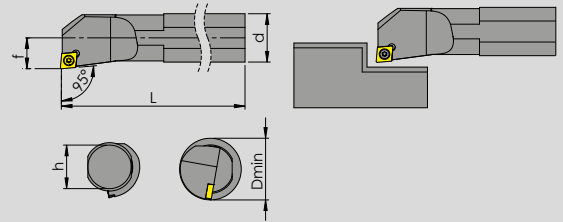
TEKNİK ÇİZİM / TECHNICAL DRAWING

TAKIM KODU ORDERING CODE			KATER ÖLÇÜLERİ DIMENSIONS (mm)					KESİCİ UÇ INSERT	YEDEK PARÇALAR / SPARE PARTS			
									BASKI VİDASI SCREW	ALTLIK SHIM	ALTLIK VİDASI SHIM SCREW	ANAHTAR TORX KEY
			d	h	L	f	Dmin					
S06-08H	SCLCR/L	06	06-08	7	115	4,5	8	CCM.. 06 02..	VRT 04 M2,5x7			T08
S08H	SCLCR/L	06	08	7	115	6	11					
S10J	SCLCR/L	06	10	9	120	7	13					
S12K	SCLCR/L	06	12	11	125	9	16					
S08-16M	SCLCR/L	06	08-16	15	150	6	11					
S10-16M	SCLCR/L	06	10-16	15	150	7	13					
S12-16M	SCLCR/L	06	12-16	15	150	9	16					
S12K	SCLCR/L	09	12	11	125	9	16	CCM.. 09 T3..	VRT 04 M2,5x7			T08
S16Q	SCLCR/L	09	16	15	180	11	21	CCM.. 09 T3..	VRT 06 M3,5x9			T15
S20R	SCLCR/L	09	20	18	200	13	25					
S25S	SCLCR/L	09	25	23	250	17	32					
S25S	SCLCR/L	12	25	23	250	17	32	CCM.. 12 04..	VRT 10 M4,5x12			T15
S32T	SCLCR/L	12	32	30	300	22	40					

STUCR





ÜRÜN / PRODUCT

93°

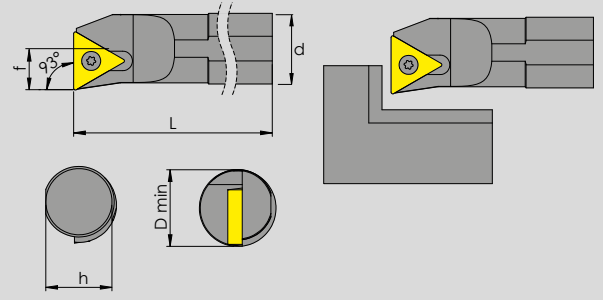

TEKNİK ÇİZİM / TECHNICAL DRAWING



TAKIM KODU ORDERING CODE			KATER ÖLÇÜLERİ DIMENSIONS (mm)					KESİCİ UÇ INSERT	YEDEK PARÇALAR / SPARE PARTS			
									BASKI VİDASI SCREW	ALTLIK SHIM	ALTLIK VİDASI SHIM SCREW	ANAHTAR TORX KEY
			d	h	L	f	Dmin					
S10J	STUCR/L	09	10	9	120	7	13	TCM.. 09 02	VRT 02 M2,2x5			T06
S12K	STUCR/L	09	12	11	125	9	16					
S12K	STUCR/L	11	12	11	125	9	16	TCM.. 11 T3..	VRT 04 M2,5x7			T08
S16Q	STUCR/L	11	16	15	180	11	20					
S20R	STUCR/L	11	20	18	200	13	25	TCM.. 16 T3..	VRT 06 M3,5x9			T15
S16Q	STUCR/L	16	16	15	180	11	20					
S20R	STUCR/L	16	20	18	200	13	25					
S25S	STUCR/L	16	25	23	250	17	32	TCM.. 16 T3..	VRT 08 M3,5x16	VRTC 16	VAV 06 M5.05	T15
S32T	STUCR/L	16	32	30	300	22	40					

STFPR





ÜRÜN / PRODUCT

90°

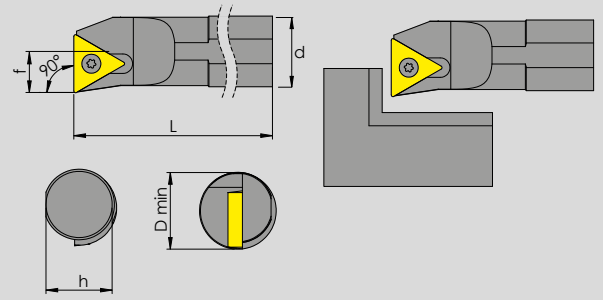

TEKNİK ÇİZİM / TECHNICAL DRAWING



TAKIM KODU ORDERING CODE			KATER ÖLÇÜLERİ DIMENSIONS (mm)					KESİCİ UÇ INSERT	YEDEK PARÇALAR / SPARE PARTS			
									BASKI VİDASI SCREW	ALTLIK SHIM	ALTLIK VİDASI SHIM SCREW	ANAHTAR TORX KEY
			d	h	L	f	Dmin					
S10J	STFPR/L	11	10	09	120	7	13	TPM.. 11 03..	VRT 05 M3x8			T10
S12K	STFPR/L	11	12	11	125	9	16					
S16Q	STFPR/L	11	16	15	180	11	20					
S20R	STFPR/L	11	20	18	200	13	25					

SCR-SCL

ÜRÜN / PRODUCT

95°



TEKNİK ÇİZİM / TECHNICAL DRAWING

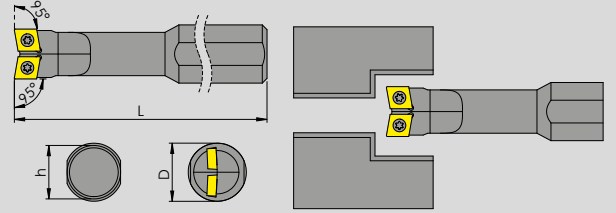

TAKIM KODU ORDERING CODE			KATER ÖLÇÜLERİ DIMENSIONS (mm)					KESİCİ UÇ INSERT	YEDEK PARÇALAR / SPARE PARTS			
									BASKI VİDASI SCREW	ALTLIK SHIM	ALTLIK VİDASI SHIM SCREW	ANAHTAR TORX KEY
			d	h	L	f	Dmin					
S25S	SCR-SCL	09	25	23	250	22	X	CCM..	VRT 07			
S32T	SCR-SCL	09	32	30	300	27	X	09 T3..	M3,5x11			T15





VİDA TAKIMLARI

Screw plugs

www.vorgen.com



The red power for
the professionals
Profesyoneller için
Kırmızı Güç

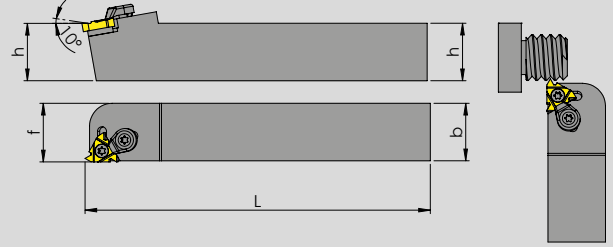

TAKIM KODU ORDERING CODE			KATER ÖLÇÜLERİ DIMENSIONS (mm)				KESİCİ UÇ INSERT	YEDEK PARÇALAR / SPARE PARTS					
								SIKMA VİDASI SCREW	ALTLIK SHIM	ALTLIK VİDASI SHIM SCREW	BASKI PARÇASI WEDGE CLAMP	BASKI VİDASI SPRING	TORX ANAHTAR TORX KEY
SER/L	0808	E11	08	08	70	11	ER/L.11	VRT 04 M2,5x7					T08
SER/L	1010	E11	10	10	70	11							
SER/L	1212	F11	12	12	80	11	ER/L.11	VRT 04 M2,5x7					T08
SER/L	1616	H11	16	16	100	16							
SER/L	1212	F16	12	12	100	14,5	ER/L.16	VRT 09 M4x11		VCP 03	VRT 06 M3,5x9	T15	
SER/L	1616	H16	16	16	100	16	ER/L.16	VRT 07 M3,5x11	VRIR 16	VAV 06 M5.05	VCP 03	VRT 09 M4x11	T15
SER/L	2020	K16	20	20	125	20							
SER/L	2525	M16	25	25	150	25							
SER/L	3232	P16	32	32	170	32	ER/L.22	VRT 09 M4x11	VRIR 22	VAV 07 M6	VCP 03	VRT 09 M4x11	T20
SER/L	2525	M22	25	25	150	25							
SER/L	3232	P22	32	32	170	32							

STİR





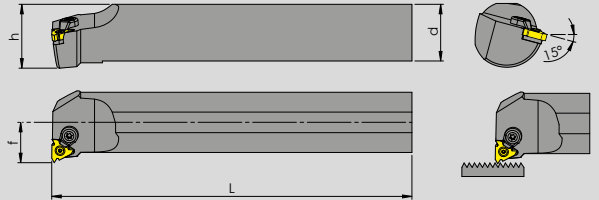

ÜRÜN / PRODUCT

93°



TEKNİK ÇİZİM / TECHNICAL DRAWING



TAKIM KODU ORDERING CODE			KATER ÖLÇÜLERİ DIMENSIONS (mm)					KESİCİ UÇ INSERT	YEDEK PARÇALAR / SPARE PARTS										
									SIKMA VİDASI SCREW	ALTLIK SHIM	ALTLIK VİDASI SHIM SCREW	BASKI PARÇASI WEDGE CLAMP	BASKI VİDASI SPRING	TORX ANAHTAR TORX KEY					
STİR/L	S10J	11	d	h	L	f	Dmin												
STİR/L	S12K	11	10	9	120	7,4	12	IR/L.11	VRT 04 M2,5x7					T08					
STİR/L	S16Q	11	12	11	125	8,4	16												
STİR/L	S16Q	11	16	15	180	7,4	12												
STİR/L	S13-16M	16	16	14,5	150	9,5	15	IR/L.16	VRT 06 M3,5x9					T15					
STİR/L	S16Q	16	16	15	180	7,4	12												
STİR/L	S20R	16	20	18	200	13,7	24												
STİR/L	S25S	16	25	23	250	16,2	29	IR/L.16	VRT 07 M3,5x11	VRIR 16	VAV 06 M5.05	VCP 03	VRT 09 M4x11	T15					
STİR/L	S32T	16	32	30	300	19,7	36												
STİR/L	S40U	16	40	37	300	23,7	44												
STİR/L	S20R	22	20	18	200	14	24	IR/L.22	VRT 07 M4,5x11			VCP 03	VRT 10 M4,5x12	T20					
STİR/L	S25S	22	25	23	250	18,1	29	IR/L.22	VRT 07 M4,5x11	VRIR 22	VAV 07 M6	VCP 03	VRT 10 M4,5x12	T20					
STİR/L	S32T	22	32	30	300	21,6	38												
STİR/L	S40U	22	40	37	300	25,6	16												
STİR/L	S50V	22	50	47	350	30,6	58												



The red power for
the professionals
Profesyoneller için
KIRMIZI GÜÇ

VORGEN®
BKTR R390 2525 2C
(R390 IFRN 1.9.2.9)

VORGEN
G1011 2020R 3C G



DIŞ ÇAP
KANAL AÇMA TAKIMLARI
External grooving toolholders

www.vorgen.com



TEKNİK ÇİZİM / TECHNICAL DRAWING

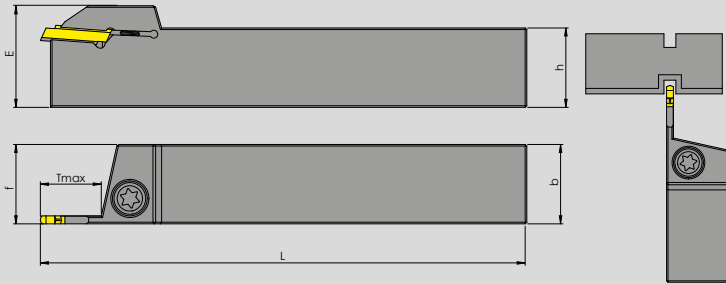

TAKIM KODU ORDERING CODE	KATER ÖLÇÜLERİ DIMENSIONS (mm)										KESİCİ UÇ INSERT	YEDEK PARÇALAR / SPARE PARTS	
	h	b	L	f	E	A	Tmax		BASKI VİDASI SPRING	TORX ANAHTAR ALLEN KEY			
BKTR/L KH 1212 2C	12	12	100	12,3	24	1,8	15						
BKTR/L KH 1616 2C	16	16	125	16	30	1,8	15						
BKTR/L KH 2020 2C	20	20	125	20	30	1,8	15						
BKTR/L KH 2525 2C	25	25	150	25	34	1,8	15						
BKTR/L KH 2020 3C	20	20	125	20	30	2,5	20						
BKTR/L KH 2525 3C	25	25	150	25	34	3	22						
BKTR/L KH 2020 4C	20	20	125	20	30	3	22						
BKTR/L KH 2525 4C	25	25	150	25	34	4	22						
BKTR/L KH 2020 5C	20	20	125	20	30	4,2	22						
BKTR/L KH 2525 5C	25	25	150	25	34	2,5	22						

BKTR/BH

ÜRÜN / PRODUCT

HORN UCUNA UYGUNDUR



TEKNİK ÇİZİM / TECHNICAL DRAWING

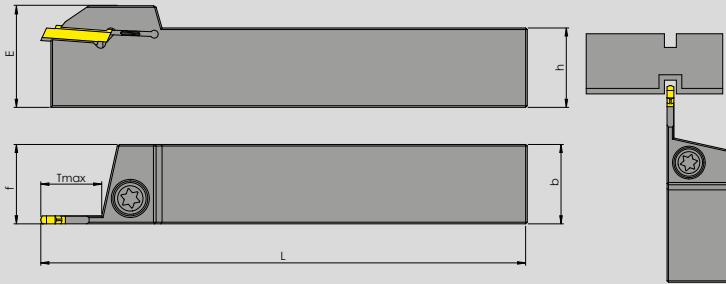

TAKIM KODU ORDERING CODE		KATER ÖLÇÜLERİ DIMENSIONS (mm)								KESİCİ UÇ INSERT	YEDEK PARÇALAR / SPARE PARTS		
											BASKI VİDASI SPRING	TORX ANAHTAR ALLEN KEY	
BKTR/L	BH	2020	3C	h	b	L	f	E	A	Tmax			
BKTR/L	BH	2525	3C	20	20	125	20	30	2,5	20		VRV 06 M8	AA4
BKTR/L	BH	3232	3C	32	32	150	32	34	2,5	22			
BKTR/L	BH	2020	4C	20	20	125	20	30	2,5	32			
BKTR/L	BH	2525	4C	25	25	150	25	34	3,5	32		VRV 06 M8	AA4
BKTR/L	BH	3232	4C	32	32	170	32	42	3,5	22			
BKTR/L	BH	2525	5C	25	25	150	25	34	4,5	33			
BKTR/L	BH	3232	5C	32	32	170	32	42	4,5	22		VRV 06 M8	AA4



TEKNİK ÇİZİM / TECHNICAL DRAWING

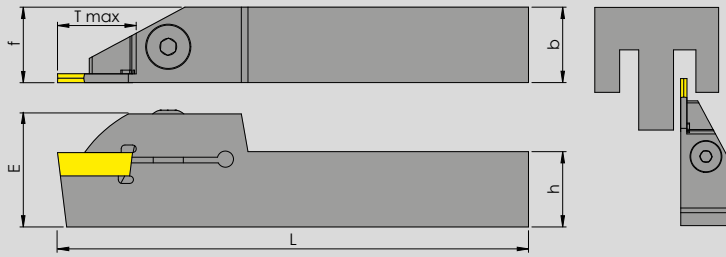

TAKIM KODU ORDERING CODE		KATER ÖLÇÜLERİ DIMENSIONS (mm)								KESİCİ UÇ INSERT	YEDEK PARÇALAR / SPARE PARTS	
											BASKI VIDASI SPRING	TORX ANAHTAR ALLEN KEY
BKTR/L	IS 1212 2C	12	12	100	12	24	1,8	15	DGN.2	VRV 02 M6	AA3	
BKTR/L	IS 1616 2C	16	16	125	16	30	1,8	15	DGN.2	VRV 06 M8	AA4	
BKTR/L	IS 2020 2C	20	20	125	20	30	1,8	17				
BKTR/L	IS 2525 2C	25	25	150	25	34	1,8	17				
BKTR/L	IS 3232 2C	32	32	170	32	42	1,8	15				
BKTR/L	IS 1212 3C	12	12	100	12	24	2,5	17	DGN.3	VRV 02 M6	AA3	
BKTR/L	IS 1616 3C	16	16	125	16	30	2,5	15	DGN.3	VRV 06 M8	AA4	
BKTR/L	IS 2020 3C	20	20	125	20	30	2,5	20				
BKTR/L	IS 2525 3C	25	25	150	25	34	2,5	22				
BKTR/L	IS 3232 3C	32	32	170	32	42	2,5	22				
BKTR/L	IS 2020 4C	20	20	125	20	30	3	20	DGN.4	VRV 06 M8	AA4	
BKTR/L	IS 2525 4C	25	25	150	25	34	3	22				
BKTR/L	IS 3232 4C	32	32	170	32	42	3	22				
BKTR/L	IS 2525 5C	25	25	150	25	34	4,2	25	DGN.5	VRV 06 M8	AA4	

BKTR/L JK



ÜRÜN / PRODUCT

KORLOY UCUNA UYGUNDUR

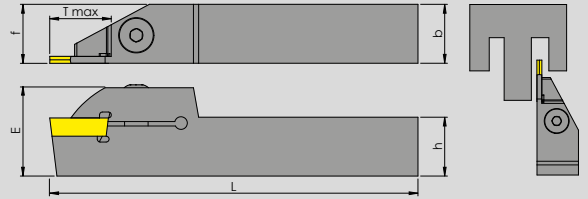

TEKNİK ÇİZİM / TECHNICAL DRAWING



TAKIM KODU ORDERING CODE		KATER ÖLÇÜLERİ DIMENSIONS (mm)								KESİCİ UÇ INSERT	YEDEK PARÇALAR / SPARE PARTS		
											BASKI VIDASI SPRING	TORX ANAHTAR ALLEN KEY	
BKTR/L	JK	1212	2C	12	12	100	12	24	1,8	15			
BKTR/L	JK	1616	2C	16	16	125	16	30	1,8	15	MGM.2	VRV 06 M8	AA4
BKTR/L	JK	2020	2C	20	20	125	20	30	1,8	15			
BKTR/L	JK	2525	2C	25	25	150	25	34	1,8	15			
BKTR/L	JK	3232	2C	32	32	170	32	42	1,8	15			
BKTR/L	JK	1212	3C	12	12	100	12	24	18	15	MGM.3	VRV 02 M6	AA3
BKTR/L	JK	1616	3C	16	16	125	16	30	2,5	15	MGM.3	VRV 06 M8	AA4
BKTR/L	JK	2020	3C	20	20	125	20	30	2,5	20			
BKTR/L	JK	2525	3C	25	25	150	25	34	2,5	22			
BKTR/L	JK	3232	3C	32	32	170	32	42	2,5	22			
BKTR/L	JK	2020	4C	20	20	125	20	30	3	22	MGM.4	VRV 06 M8	AA4
BKTR/L	JK	2525	4C	25	25	150	25	34	3	22			
BKTR/L	JK	3232	4C	32	32	170	32	42	3	22			
BKTR/L	JK	2020	5C	20	20	125	20	30	4,2	20	MGM.5	VRV 06 M8	AA4
BKTR/L	JK	2525	5C	25	25	150	25	34	4,2	25			
BKTR/L	JK	3232	5C	32	32	170	32	42	4,2	25	MGM.6	VRV 06 M8	AA4
BKTR/L	JK	2525	6C	25	25	150	25	34	5	25			
BKTR/L	JK	3232	6C	32	32	170	32	42	5	25	MGM.8	VRV 06 M8	AA4
BKTR/L	JK	2525	8C	25	25	150	25	34	7	25			
BKTR/L	JK	3232	8C	32	32	170	32	42	7	28			



TEKNİK ÇİZİM / TECHNICAL DRAWING

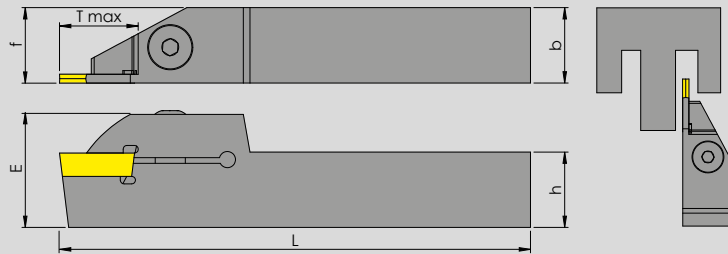

TAKIM KODU ORDERING CODE		KATER ÖLÇÜLERİ DIMENSIONS (mm)									KESİCİ UÇ INSERT	YEDEK PARÇALAR / SPARE PARTS	
		h	b	L	f	E	A	Tmax	BASKI VIDASI SPRING	TORX ANAHTAR ALLEN KEY			
BKTR/L	TDC	1616	2C	16	16	125	16	30	1,8	15	TDC.2		
BKTR/L	TDC	2020	2C	20	20	125	20	30	1,8	15			
BKTR/L	TDC	2525	2C	25	25	150	25	34	2,5	17			
BKTR/L	TDC	1616	3C	16	16	125	16	30	2,5	15	TDC.3		
BKTR/L	TDC	2020	3C	20	20	125	20	30	2,5	20			
BKTR/L	TDC	2525	3C	25	25	150	25	34	2,5	22			
BKTR/L	TDC	2020	4C	20	20	125	20	30	3	20	TDC.4		
BKTR/L	TDC	2525	4C	25	25	150	25	34	3	22			



TEKNİK ÇİZİM / TECHNICAL DRAWING

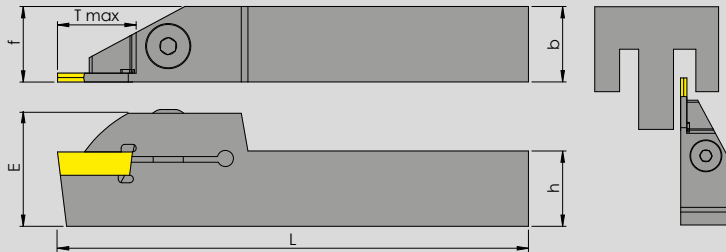

TAKIM KODU ORDERING CODE				KATER ÖLÇÜLERİ DIMENSIONS (mm)							KESİCİ UÇ INSERT	YEDEK PARÇALAR / SPARE PARTS	
												BASKI VIDASI SPRING	TORX ANAHTAR ALLEN KEY
BKTR/L	ZCC2	2020	2C	h	b	L	f	E	A	Tmax			
BKTR/L	ZCC2	2525	2C	20	20	125	20	30	1,6	15			
BKTR/L	ZCC2	2525	3C	25	25	150	25	34	16	15			
BKTR/L	ZCC2	2020	3C	20	20	125	20	30	2,5	20			
BKTR/L	ZCC2	2525	3C	25	25	150	25	34	2,5	22			
BKTR/L	ZCC2	2020	4C	20	20	125	20	30	3	20			
BKTR/L	ZCC2	2525	4C	25	25	150	25	34	3	22			
BKTR/L	ZCC2	2020	5C	20	20	125	20	30	4	20			
BKTR/L	ZCC2	2525	5C	25	25	150	25	34	4	25			
BKTR/L	ZCC2	2525	6C	25	25	150	25	34	5,5	25			



TEKNİK ÇİZİM / TECHNICAL DRAWING

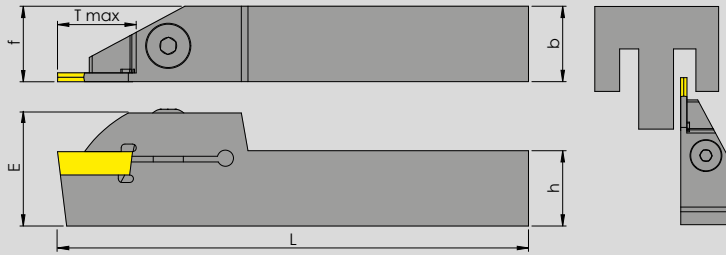

TAKIM KODU ORDERING CODE				KATER ÖLÇÜLERİ DIMENSIONS (mm)							KESİCİ UÇ INSERT	YEDEK PARÇALAR / SPARE PARTS	
												BASKI VIDASI SPRING	TORX ANAHTAR ALLEN KEY
BKTR/L	S123	1212	2C	h	b	L	f	E	A	Tmax			
BKTR/L	S123	1212	2C	12	12	100	12	24	1,8	15	S123.2	VRV 02 M6	AA3
BKTR/L	S123	1616	2C	16	16	125	16	30	1,8	15	S123.2	VRV 06 M8	AA4
BKTR/L	S123	2020	2C	20	20	125	20	30	1,8	15			
BKTR/L	S123	2525	2C	25	25	150	25	34	1,8	15			
BKTR/L	S123	3232	2C	32	32	170	32	42	1,8	15			
BKTR/L	S123	1212	3C	12	12	100	12	24	2,5	20	S123.3	VRV 02 M6	AA3
BKTR/L	S123	1616	3C	16	16	125	16	30	2,5	20	S123.3	VAV 06 M8	AA4
BKTR/L	S123	2020	3C	20	20	125	20	30	2,5	20			
BKTR/L	S123	2525	3C	25	25	150	25	34	2,5	20			
BKTR/L	S123	3232	3C	32	32	170	32	42	2,5	20			
BKTR/L	S123	2020	4C	20	20	125	20	30	3	22	S123.4	VRV 06 M8	AA4
BKTR/L	S123	2525	4C	25	25	150	25	34	3	22			
BKTR/L	S123	3232	4C	32	32	170	32	42	3	22			
BKTR/L	S123	2525	5C	25	25	150	25	34	4,2	25	S123.5	VRV 06 M8	AA4
BKTR/L	S123	2525	6C	25	25	150	25	34	5	25	S123.6	VRV 06 M8	AA4



TEKNİK ÇİZİM / TECHNICAL DRAWING

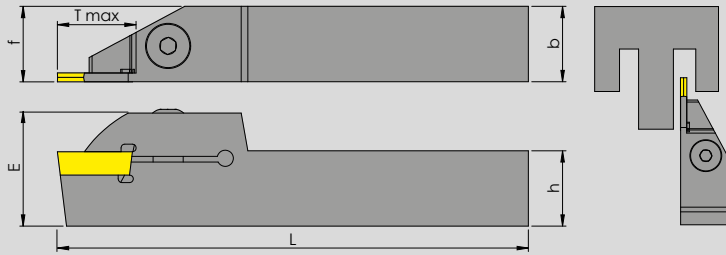

TAKIM KODU ORDERING CODE				KATER ÖLÇÜLERİ DIMENSIONS (mm)							KESİCİ UÇ INSERT	YEDEK PARÇALAR / SPARE PARTS	
												BASKI VİDASI SPRING	TORX ANAHTAR ALLEN KEY
BKTR/L	DGM	1616	2C	h	b	L	f	E	A	Tmax			
BKTR/L	DGM	2020	2C	16	16	125	16	30	1,8	15	DGM.2	VRV 06 M8	AA4
BKTR/L	DGM	2525	2C	20	20	125	20	30	1,8	15			
BKTR/L	DGM	2525	2C	25	25	150	25	34	2,5	17			
BKTR/L	DGM	1616	3C	16	16	125	16	30	2,5	15	DGM.3	VRV 06 M8	AA4
BKTR/L	DGM	2020	3C	20	20	125	20	30	2,5	20			
BKTR/L	DGM	2525	3C	25	25	150	25	34	2,5	22			
BKTR/L	DGM	2020	4C	20	20	125	20	30	3	20	DGM.4	VRV 06 M8	AA4
BKTR/L	DGM	2525	4C	25	25	150	25	34	3	22			



TEKNİK ÇİZİM / TECHNICAL DRAWING

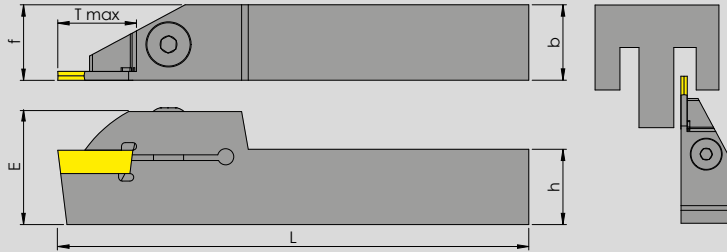

TAKIM KODU ORDERING CODE				KATER ÖLÇÜLERİ DIMENSIONS (mm)							KESİCİ UÇ INSERT	YEDEK PARÇALAR / SPARE PARTS	
												BASKI VİDASI SPRING	TORX ANAHTAR ALLEN KEY
BKTR/L	GX24	1616	2C	h	b	L	f	E	A	Tmax			
BKTR/L	GX24	2020	2C	16	16	125	16	30	1,8	15		VRV 06 M8	AA4
BKTR/L	GX24	2525	2C	20	20	125	20	30	1,8	15			
BKTR/L	GX24	2525	2C	25	25	150	25	34	2,5	17			
BKTR/L	GX24	1616	3C	16	16	125	16	30	2,5	15		VRV 06 M8	AA4
BKTR/L	GX24	2020	3C	20	20	125	20	30	2,5	20			
BKTR/L	GX24	2525	3C	25	25	150	25	34	2,5	22			
BKTR/L	GX24	2020	4C	20	20	125	20	30	3	20		VRV 06 M8	AA4
BKTR/L	GX24	2525	4C	25	25	150	25	34	3	22			

BKTR/L GDM

ÜRÜN / PRODUCT

KYOCERA UCUNA UYGUNDUR



TEKNİK ÇİZİM / TECHNICAL DRAWING

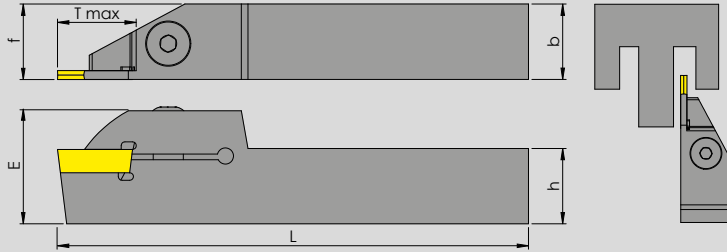

TAKIM KODU ORDERING CODE				KATER ÖLÇÜLERİ DIMENSIONS (mm)							KESİCİ UÇ INSERT	YEDEK PARÇALAR / SPARE PARTS	
												BASKI VİDASI SPRING	TORX ANAHTAR ALLEN KEY
				h	b	L	f	E	A	Tmax			
BKTR/L	GDM	1616	2C	16	16	125	16	30	1,8	15	GDM.2	VRV 06 M8	AA4
BKTR/L	GDM	2020	2C	20	20	125	20	30	1,8	15			
BKTR/L	GDM	2525	2C	25	25	150	25	34	2,5	17			
BKTR/L	GDM	1616	3C	16	16	125	16	30	2,5	15	GDM.3	VRV 06 M8	AA4
BKTR/L	GDM	2020	3C	20	20	125	20	30	2,5	20			
BKTR/L	GDM	2525	3C	25	25	150	25	34	2,5	22			
BKTR/L	GDM	2020	4C	20	20	125	20	30	3	20	GDM.4	VRV 06 M8	AA4
BKTR/L	GDM	2525	4C	25	25	150	25	34	3	22			



TEKNİK ÇİZİM / TECHNICAL DRAWING

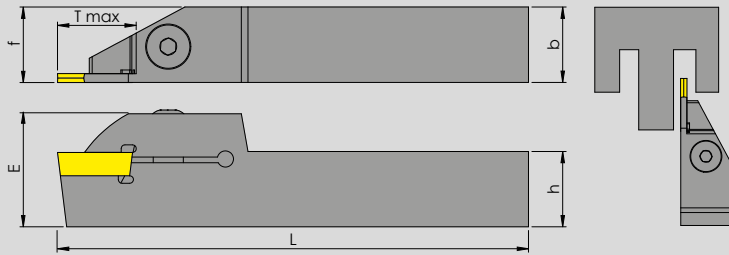

TAKIM KODU ORDERING CODE				KATER ÖLÇÜLERİ DIMENSIONS (mm)							KESİCİ UÇ INSERT	YEDEK PARÇALAR / SPARE PARTS	
												BASKI VİDASI SPRING	TORX ANAHTAR ALLEN KEY
				h	b	L	f	E	A	Tmax			
BKTR/L	KGM	1616	2C	16	16	125	16	30	1,8	15	KG MN.2	VRV 06 M8	AA4
BKTR/L	KGM	2020	2C	20	20	125	20	30	1,8	15			
BKTR/L	KGM	2525	2C	25	25	150	25	34	2,5	17			
BKTR/L	KGM	1616	3C	16	16	125	16	30	2,5	15	KG MN.3	VRV 06 M8	AA4
BKTR/L	KGM	2020	3C	20	20	125	20	30	2,5	20			
BKTR/L	KGM	2525	3C	25	25	150	25	34	2,5	22			
BKTR/L	KGM	2020	4C	20	20	125	20	30	3	20	KG MN.4	VRV 06 M8	AA4
BKTR/L	KGM	2525	4C	25	25	150	25	34	3	22			



TEKNİK ÇİZİM / TECHNICAL DRAWING

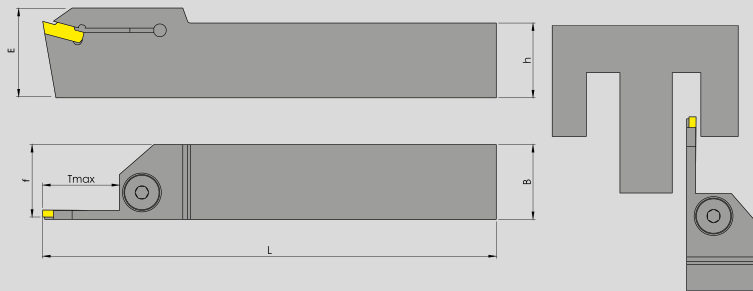

TAKIM KODU ORDERING CODE				KATER ÖLÇÜLERİ DIMENSIONS (mm)							KESİCİ UÇ INSERT	YEDEK PARÇALAR / SPARE PARTS	
												BASKI VIDASI SPRING	TORX ANAHTAR ALLEN KEY
BKTR	LCM	2020	3C	h	b	L	f	E	A	Tmax	 LCMF3	 VRV 06 M8	 AA4
BKTR	LCM	2525	3C	20	20	125	20	28	2,5	20		 VRV 06 M8	 AA4

BKTR/154.91

ÜRÜN / PRODUCT

SANDWIK UCUNA UYGUNDUR



TEKNİK ÇİZİM / TECHNICAL DRAWING



TAKIM KODU ORDERING CODE				KATER ÖLÇÜLERİ DIMENSIONS (mm)							KESİCİ UÇ INSERT	YEDEK PARÇALAR / SPARE PARTS		
												BASKI PARÇASI WEDGE CLAMP	BASKI VİDASI SCREW	TORX ANAHTAR TORX KEY
				h	b	L	f	E	A	Tmax				
BKTR/L	154.91	2020	3Q	20	20	125	20	25	2,5	4	154.91-3	VCP 03	VRT 09 M4x11	T15
BKTR/L	154.91	2525	3Q	25	25	150	25	25	2,5	4				

BKTR/R390

ÜRÜN / PRODUCT

HORN UCUNA UYGUNDUR



TEKNİK ÇİZİM / TECHNICAL DRAWING

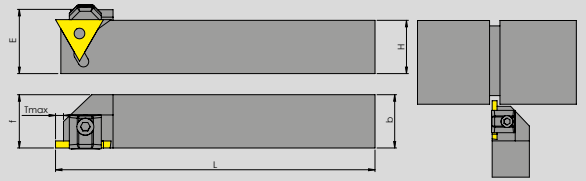

TAKIM KODU ORDERING CODE				KATER ÖLÇÜLERİ DIMENSIONS (mm)							KESİCİ UÇ INSERT	YEDEK PARÇALAR / SPARE PARTS		
												BASKI PARÇASI WEDGE CLAMP	BASKI VİDASI SPRING	TORX ANAHTAR ALLEN KEY
				h	b	L	f	E	A	Tmax				
BKTR/L	R390	2525	2C (1.9 2.9)	25	25	150	25	25	1,8	6	R390 HRN	VKP 01	VRV 09 M6	AA4
BKTR/L	R390	2525	3C (2.9 3.9)	25	25	150	25	25	3	6				
BKTR/L	R390	2525	4C (3.9 4.9)	25	25	150	25	25	4	6				



PASO

ÜRÜN / PRODUCT

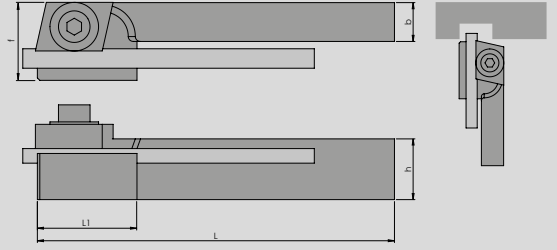

TEKNİK ÇİZİM / TECHNICAL DRAWING



TAKIM KODU ORDERING CODE		KATER ÖLÇÜLERİ DIMENSIONS (mm)					KESİCİ UÇ INSERT	YEDEK PARÇALAR / SPARE PARTS		
								BASKI PARÇASI WEDGE CLAMP	BASKI VİDASI SCREW	ANAHTAR ALLEN KEY
PASO	6x8	f	h	b	L	L1				
PASO	8x10	32	25	16	150	50	6x6-8x8	BPV M8	VRV8 M8x25	AA6
PASO	10x12	34	25	16	150	50	8x8-10x10			
PASO	12x14	36	25	16	150	50	10x10-12x12			
PASO	12x14	38	25	16	150	50	12x12-14x14			



KESME

ÜRÜN / PRODUCT

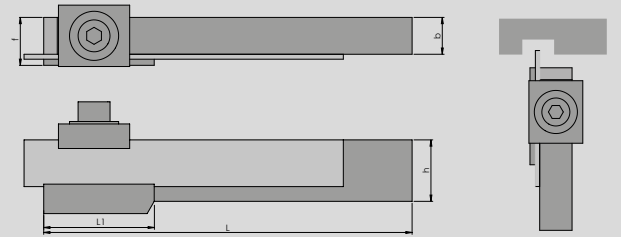

TEKNİK ÇİZİM / TECHNICAL DRAWING



TAKIM KODU ORDERING CODE		KATER ÖLÇÜLERİ DIMENSIONS (mm)					KESİCİ UÇ INSERT	YEDEK PARÇALAR / SPARE PARTS		
								BASKI PARÇASI WEDGE CLAMP	BASKI VİDASI SCREW	ANAHTAR ALLEN KEY
KESME	1/2	f	h	b	L	L1				
KESME	5/8	24	25	16	130	50	12,7x3-4	BBV M8	VRV8 M8x25	AA6
KESME	3/4	24	25	16	130	50	15,8x3-4			
KESME	7/8	30	25	16	150	50	19x3-4,5			
KESME	1	35	25	16	150	50	22x4-5			
KESME	1	35	25	16	150	50	25x4-5			



DIŞ ÇAP ALIN KANAL AÇMA TAKIMLARI

Face external
grooving toolholders

www.vorgen.com

The red power for
the professionals
Profesyoneller için
Kırmızı Güç

BKATR/L JK



ÜRÜN / PRODUCT

KORLOY UCUNA UYGUNDUR

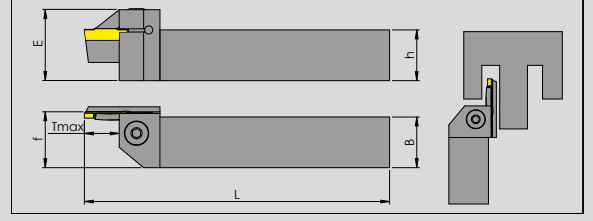

TEKNİK ÇİZİM / TECHNICAL DRAWING



TAKIM KODU ORDERING CODE				KATER ÖLÇÜLERİ DIMENSIONS (mm)									KESİCİ UÇ INSERT	YEDEK PARÇALAR / SPARE PARTS	
														BASKI VIDASI SCREW	TORX ANAHTAR ALLEN KEY
BKATR/L-JK	2525	(34-45)	2C	h	b	L	f	E	A	Tmax	Dmin	Dmax			
BKATR/L-JK	2525	(39-55)	2C	25	25	150	26,5	34	1,8	15	34	45	MGM.2	VRV 06 M8	AA4
BKATR/L-JK	2525	(34-45)	3C	25	25	150	26,5	34	2,2	18	34	45			
BKATR/L-JK	2525	(39-55)	3C	25	25	150	26,5	34	2,2	18	39	55	MGM.3	VRV 06 M8	AA4
BKATR/L-JK	2525	(49-80)	3C	25	25	150	26,5	34	2,2	18	49	80			
BKATR/L-JK	2525	(70-110)	3C	25	25	150	26,5	34	2,2	18	70	110			
BKATR/L-JK	2525	(100-150)	3C	25	25	150	26,5	34	2,2	18	100	150			



BKLTR/L JK

ÜRÜN / PRODUCT

KORLOY UCUNA UYGUNDUR



TEKNİK ÇİZİM / TECHNICAL DRAWING

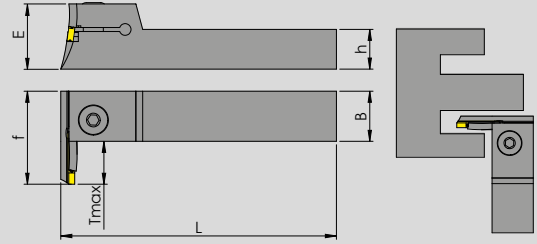

TAKIM KODU ORDERING CODE				KATER ÖLÇÜLERİ DIMENSIONS (mm)									KESİCİ UÇ INSERT	YEDEK PARÇALAR / SPARE PARTS	
														BASKI VIDASI SCREW	TORX ANAHTAR ALLEN KEY
BKLTR/L-JK	2525	(25-35)	3C	h	b	L	f	E	A	Tmax	Dmin	Dmax	MGM.3	VRV 06 M8	AA4
BKLTR/L-JK	2525	(35-55)	3C	25	25	150	37	34	2,2	12	25	35			
BKLTR/L-JK	2525	(50-75)	3C	25	25	150	37	34	2,2	12	50	75			
BKLTR/L-JK	2525	(70-105)	4C	25	25	150	37	34	3,2	14	70	105			
BKLTR/L-JK	2525	(100-205)	4C	25	25	150	37	34	3,2	14	100	205			

BKLTR/L GX24

ÜRÜN / PRODUCT

WALTER UCUNA UYGUNDUR



TEKNİK ÇİZİM / TECHNICAL DRAWING

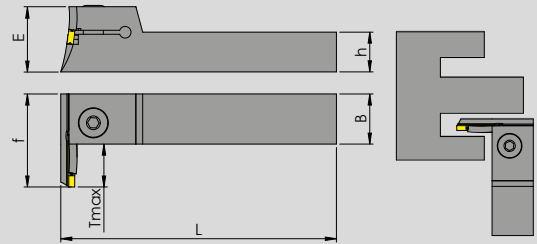

TAKIM KODU ORDERING CODE				KATER ÖLÇÜLERİ DIMENSIONS (mm)									KESİCİ UÇ INSERT	YEDEK PARÇALAR / SPARE PARTS	
														BASKI VIDASI SCREW	TORX ANAHTAR ALLEN KEY
BKLTR/L-GX24	2525	(25-35)	3C	h	b	L	f	E	A	Tmax	Dmin	Dmax	GX24.3	VRV 06 M8	AA4
BKLTR/L-GX24	2525	(35-55)	3C	25	25	150	37	34	2,2	12	35	55			
BKLTR/L-GX24	2525	(50-75)	3C	25	25	150	37	34	2,2	12	50	75			
BKLTR/L-GX24	2525	(70-105)	4C	25	25	150	37	34	3,2	14	70	105	GX24.4		
BKLTR/L-GX24	2525	(100-205)	4C	25	25	150	37	34	3,2	14	100	205			

BKTI-R/KH

ÜRÜN / PRODUCT

HORN UCUNA UYGUNDUR



TEKNİK ÇİZİM / TECHNICAL DRAWING

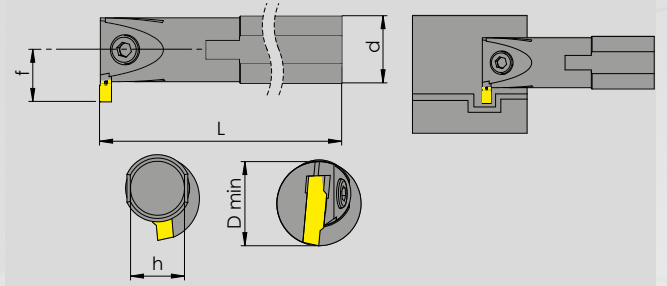

TAKIM KODU ORDERING CODE				KATER ÖLÇÜLERİ DIMENSIONS (mm)					KESİCİ UÇ INSERT	YEDEK PARÇALAR / SPARE PARTS	
										BASKI VİDASI SCREW	TORX ANAHTAR ALLEN KEY
				L	d	f	h	Tmax			
BKTI-R/L	KH	S16Q	2C	180	16	11	14	4	S224.2	VRV 07 M5	AA4
BKTI-R/L	KH	S20R	2C	190	20	13	18				
BKTI-R/L	KH	S25R	2C	200	25	17	23	6	S224.3	VRV 08 M5	AA4
BKTI-R/L	KH	S20R	3C	190	20	13	18				
BKTI-R/L	KH	S25R	3C	200	25	17	23	6	S224.4	VRV 08 M5	AA4
BKTI-R/L	KH	S20R	4C	190	20	13	18				
BKTI-R/L	KH	S25R	4C	200	25	17	23	6	S224.5	VRV 08 M5	AA4
BKTI-R/L	KH	S25R	5C	200	25	17	23				

BKTI TGM3

ÜRÜN / PRODUCT

ISCAR UCUNA UYGUNDUR



TEKNİK ÇİZİM / TECHNICAL DRAWING

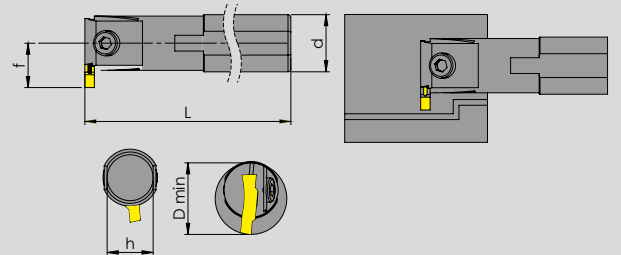

TAKIM KODU ORDERING CODE				KATER ÖLÇÜLERİ DIMENSIONS (mm)					KESİCİ UÇ INSERT	YEDEK PARÇALAR / SPARE PARTS	
										BASKI VİDASI SCREW	TORX ANAHTAR ALLEN KEY
				L	d	f	h	Tmax			
BKTI-R/L	TGM3	S16Q	3C	180	16	12	14,5	6	TGM.3	VRV 07 M5	T20
BKTI-R/L	TGM3	S20R	3C	200	20	14,2	18,5				



BKTI-R/L JK

ÜRÜN / PRODUCT

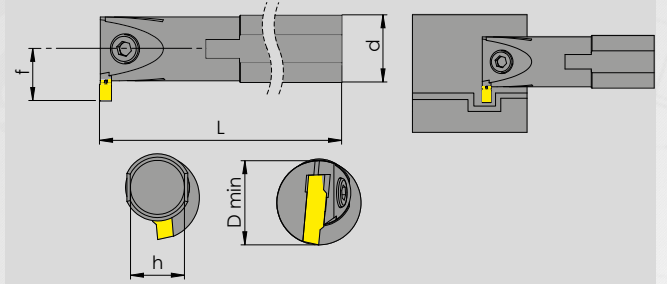

TEKNİK ÇİZİM / TECHNICAL DRAWING



TAKIM KODU ORDERING CODE				KATER ÖLÇÜLERİ DIMENSIONS (mm)					Kesici UÇ INSERT	YEDEK PARÇALAR / SPARE PARTS	
										BASKI VİDASI SCREW	TORX ANAHTAR ALLEN KEY
				L	d	f	h	Tmax			
BKTI-R/L	JK	S16Q	2C	180	16	11	14	4	MGM.2	VRV 07 M5	AA4
BKTI-R/L	JK	S20R	2C	190	20	13	18				
BKTI-R/L	JK	S25R	2C	200	25	17	23				
BKTI-R/L	JK	S32T	2C	300	32	17	30				
BKTI-R/L	JK	S16Q	3C	180	16	11	14	6	MGM.3	VRV 07 M5	
BKTI-R/L	JK	S20R	3C	190	20	13	18				
BKTI-R/L	JK	S25R	3C	200	25	17	23				
BKTI-R/L	JK	S32T	3C	300	32	17	30				
BKTI-R/L	JK	S40T	3C	300	40	26	37,5	6	MGM.4	VRV 07 M5	
BKTI-R/L	JK	S20R	4C	190	20	13	18				
BKTI-R/L	JK	S25R	4C	200	25	17	23				
BKTI-R/L	JK	S32T	4C	300	32	17	30				
BKTI-R/L	JK	S40T	4C	300	40	26	37,5	7	MGM.5	VRV 07 M5	
BKTI-R/L	JK	S25R	5C	200	25	17	23				
BKTI-R/L	JK	S32T	5C	300	32	17	30				
BKTI-R/L	JK	S40T	5C	300	40	26	37,5	8	MGM.6	VRV 07 M5	
BKTI-R/L	JK	S25R	6C	200	25	17	23				
BKTI-R/L	JK	S32T	6C	300	32	17	30				
BKTI-R/L	JK	S40T	6C	300	40	26	37,5		MGM.6	VRV 06 M8	



BKTI-R S123

ÜRÜN / PRODUCT



TEKNİK ÇİZİM / TECHNICAL DRAWING

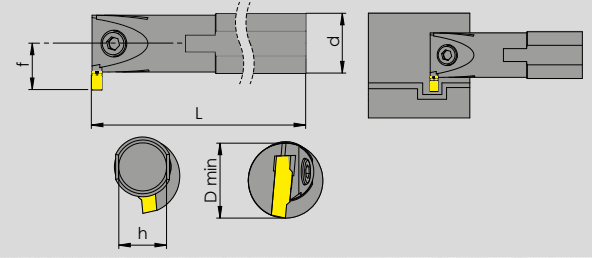

TAKIM KODU ORDERING CODE				KATER ÖLÇÜLERİ DIMENSIONS (mm)					KESİCİ UÇ INSERT	YEDEK PARÇALAR / SPARE PARTS	
										BASKI VIDASI SCREW	TORX ANAHTAR ALLEN KEY
				L	d	f	h	Tmax			
BKTI-R/L	S123	S16Q	2C	180	16	11	14	4	S123.2	VRV 07 M5	AA4
BKTI-R/L	S123	S20R	2C	190	20	13	18				
BKTI-R/L	S123	S25R	2C	200	25	17	23				
BKTI-R/L	S123	S32T	2C	300	32	17	30				
BKTI-R/L	S123	S16Q	3C	180	16	11	14	5	S123.3	VRV 07 M5	
BKTI-R/L	S123	S20R	3C	190	20	13	18				
BKTI-R/L	S123	S25R	3C	200	25	17	23				
BKTI-R/L	S123	S32T	3C	300	32	17	30				
BKTI-R/L	S123	S40T	3C	300	40	26,5	37,5	7	S123.4	VRV 06 M8	
BKTI-R/L	S123	S20R	4C	190	20	13	18				
BKTI-R/L	S123	S25R	4C	200	25	17	23				
BKTI-R/L	S123	S32T	4C	300	32	17	30				
BKTI-R/L	S123	S40T	4C	300	40	26,5	37,5	8	S123.5	VRV 07 M5	
BKTI-R/L	S123	S20R	5C	190	20	13	18				
BKTI-R/L	S123	S25R	5C	200	25	17	23				
BKTI-R/L	S123	S32T	5C	300	32	17	30				
BKTI-R/L	S123	S40T	5C	300	40	26,5	37,5				





BKTI-R 154.91

ÜRÜN / PRODUCT

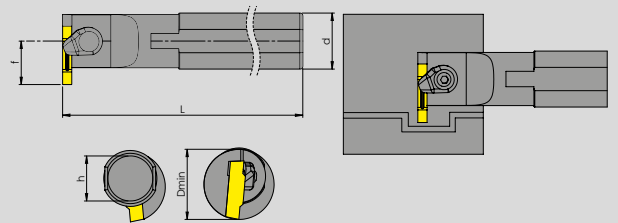

TEKNİK ÇİZİM / TECHNICAL DRAWING



TAKIM KODU ORDERING CODE				KATER ÖLÇÜLERİ DIMENSIONS (mm)					KESİCİ UÇ INSERT	YEDEK PARÇALAR / SPARE PARTS		
										BASKI PARÇASI WEDGE CLAMP	BASKI VIDASI SCREW	ANAHTAR TORX KEY
				L	d	f	h	Tmax				
BKTI-R/L	154.91	S16Q	3Q	180	16	11	14	4	154.91.3	VCP 03	VRT 09 M4x11	T15
BKTI-R/L	154.91	S20R	3Q	190	20	13	18					
BKTI-R/L	154.91	S25R	3Q	200	25	17	23					

BKTI-R IS

ÜRÜN / PRODUCT



TEKNİK ÇİZİM / TECHNICAL DRAWING

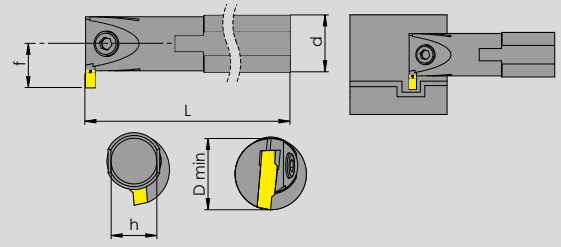

TAKIM KODU ORDERING CODE				KATER ÖLÇÜLERİ DIMENSIONS (mm)					KESİCİ UÇ INSERT	YEDEK PARÇALAR / SPARE PARTS	
										BASKI VİDASI SCREW	TORX ANAHTAR ALLEN KEY
				L	d	f	h	Tmax			
BKTI-R/L	IS	S20R	2C	190	20	13	18	5	DGN 2	VRV 07 M5	AA4
BKTI-R/L	IS	S25R	2C	200	25	17	23				
BKTI-R/L	IS	S20R	3C	190	20	13	18	6	DGN 3	VRV 07 M5	AA4
BKTI-R/L	IS	S25R	3C	200	25	17	23				

BKTI-R/BH

ÜRÜN / PRODUCT



TEKNİK ÇİZİM / TECHNICAL DRAWING

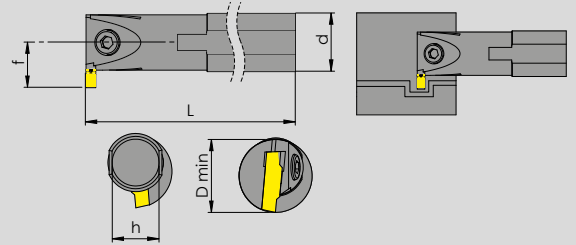

TAKIM KODU ORDERING CODE				KATER ÖLÇÜLERİ DIMENSIONS (mm)					KESİCİ UÇ INSERT	YEDEK PARÇALAR / SPARE PARTS	
										BASKI VİDASI SCREW	TORX ANAHTAR ALLEN KEY
				L	d	f	h	Tmax			
BKTI-R/L	BH	S25R	3C	200	25	17	23	7	S229-3	VRV 07 M5	AA4
BKTI-R/L	BH	S32T	3C	300	32	22	32				
BKTI-R/L	BH	S40T	3C	300	40	26,5	37,5				
BKTI-R/L	BH	S25R	4C	200	25	17	23	7	S229-4	VRV 07 M5	AA4
BKTI-R/L	BH	S32T	4C	300	32	22	32				
BKTI-R/L	BH	S40T	4C	300	40	26,5	37,5				
BKTI-R/L	BH	S25R	5C	200	25	17	23	7	S229-5	VRV 07 M5	AA4
BKTI-R/L	BH	S32T	5C	300	32	22	32				
BKTI-R/L	BH	S40T	5C	300	40	26,5	37,5				

SPTC 16



ÜRÜN / PRODUCT

45°

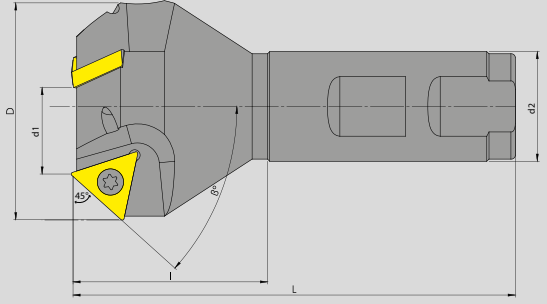

TEKNİK ÇİZİM / TECHNICAL DRAWING



TAKIM KODU ORDERING CODE			KATER ÖLÇÜLERİ DIMENSIONS (mm)				KESİCİ UÇ INSERT	YEDEK PARÇALAR / SPARE PARTS		
								KESİCİ UÇ INSERT	BASKI VIDASI SCREW	ANAHTAR TORX KEY
			D	d1	d2	L				
SPTC11	4-15x1	16-100	15	4	16	100	1	TC.. 1102	VRT03 M2,5x5	T08
SPTC16	4-23x1	16-100	23	4	16	100	1	TC.. 16T3	VRT06 M3,5x9	T15
SPTC16	10-31x2	16-100	31	10	16	100	2			
SPTC16	14-35x2	20-100	35	14	20	100	2			
SPTC16	22-43x3	25-100	43	22	25	100	3			
SPTC16	32-53x3	25-100	53	32	25	100	3			



SPSC 09

ÜRÜN / PRODUCT

45°



TEKNİK ÇİZİM / TECHNICAL DRAWING

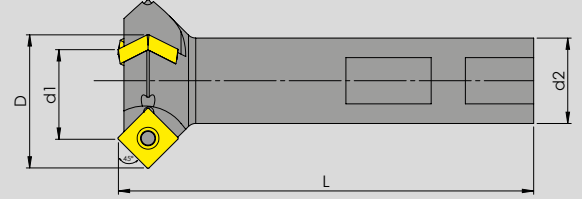

TAKIM KODU ORDERING CODE	KATER ÖLÇÜLERİ DIMENSIONS (mm)				KESİCİ UÇ INSERT	YEDEK PARÇALAR / SPARE PARTS			
	D	d1	d2	L		KESİCİ UÇ INSERT	BASKI VIDASI SCREW	ANAHTAR TORX KEY	
SPSC09	4-13x1 16 120	13	4	16	120	1			
SPSC09	19-31x3 20 120	31	19	20	120	3	SC.. 09 T3	VRT 07 M3,5x11	T15
SPSC09	20-41x3 25 120	41	20	25	120	3			
SPSC12	35-50x4 25 120	50	35	25	120	4	SC.. 1204	VRT 10 M4,5	T20

SPSP09

ÜRÜN / PRODUCT

45°



TEKNİK ÇİZİM / TECHNICAL DRAWING

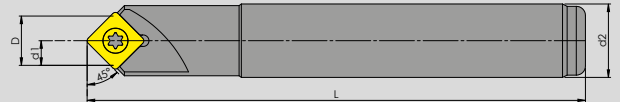

TAKIM KODU ORDERING CODE	KATER ÖLÇÜLERİ DIMENSIONS (mm)				KESİCİ UÇ INSERT	YEDEK PARÇALAR / SPARE PARTS			
	D	d1	d2	L		KESİCİ UÇ INSERT	BASKI VIDASI SCREW	ANAHTAR TORX KEY	
SPSP09	4-16x1 16 110	16	4	16	110	1	SP. 09 03	VRT 07 M3,5x11	T15



**FREZE
TAKIMLARI**
Milling tools

www.vorgen.com

VRF90S TP22

ÜRÜN / PRODUCT

90°

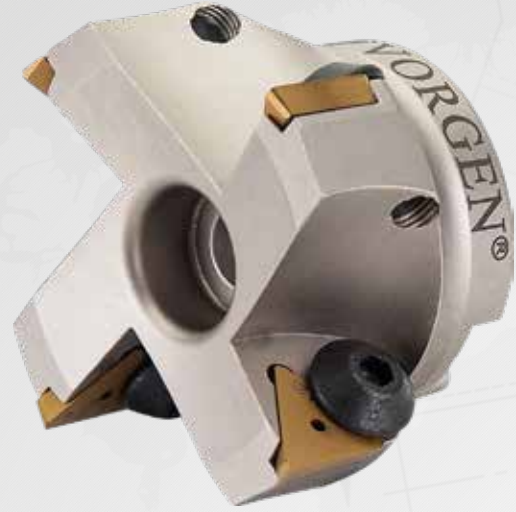

TEKNİK ÇİZİM / TECHNICAL DRAWING

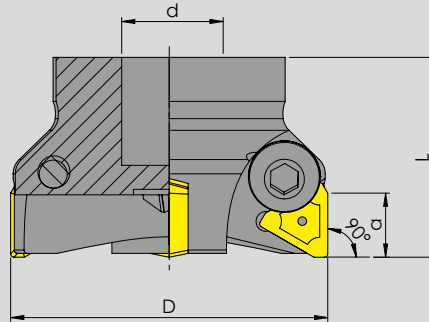

TAKIM KODU ORDERING CODE		TAKIM ÖLÇÜLERİ DIMENSIONS (mm)				KESİCİ UÇ ADET INSERT NUMBER	YEDEK PARÇALAR / SPARE PARTS							
							KESİCİ UÇ INSERT	BASKI VIDASI SCREW	ALTLIK SHIM	ALTLIK VIDASI SHIM SCREW	ANAHTAR ALLEN KEY			
VRF90S	TP22	D063	d22	Z03	63	22	40	20	3	TPKN 2204	VRV 002 M8	VRTN 22	VAV 02 M5	AA5
VRF90S	TP22	D080	d27	Z04	80	27	50	20	4					
VRF90S	TP22	D100	d32	Z05	100	32	50	20	5					
VRF90S	TP22	D125	d40	Z06	125	40	62	20	6					
VRF90S	TP22	D160	d40	Z07	160	40	62	20	7					
VRF90	TP22	D063	d22	Z03	63	22	40	20	3	TPKN 2204	VRV 002 M8			AA5
VRF90	TP22	D080	d27	Z04	80	27	50	20	4					
VRF90	TP22	D100	d32	Z05	100	32	50	20	5					
VRF90	TP22	D125	d40	Z06	125	40	62	20	6					
VRF90	TP22	D160	d40	Z07	160	40	62	20	7					

VRF90S TP16

ÜRÜN / PRODUCT

90°



TEKNİK ÇİZİM / TECHNICAL DRAWING

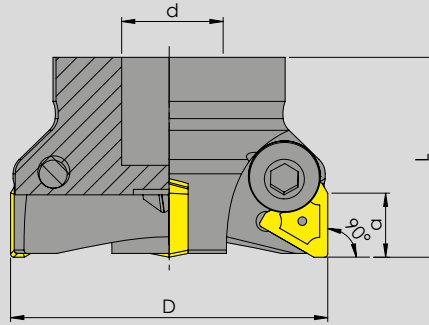

TAKIM KODU ORDERING CODE		TAKIM ÖLÇÜLERİ DIMENSIONS (mm)				KESİCİ UÇ ADET INSERT NUMBER	YEDEK PARÇALAR / SPARE PARTS							
							KESİCİ UÇ INSERT	BASKI VİDASI SCREW	ALTLIK SHIM	ALTLIK VİDASI SHIM SCREW	ANAHTAR ALLEN KEY			
VRF90S	TP16	D080	d27	Z05	80	27	50	14	5	TPKN 1603	VRV 001 M6	VRTN 16	VAV 02 M5	AA5
VRF90S	TP16	D100	d32	Z06	100	32	50	14	6					
VRF90	TP16	D042	d16	Z03	42	16	45	14	3	TPKN 1603	VRV 001 M6			AA5
VRF90	TP16	D050	d22	Z03	50	22	45	14	3					
VRF90	TP16	D063	d22	Z03	63	22	45	14	3					
VRF90	TP16	D063	d22	Z04	63	22	45	14	4					
VRF90	TP16	D080	d27	Z05	80	27	50	14	5					
VRF90	TP16	D100	d32	Z06	100	32	50	14	6					

VRF75 SP12

ÜRÜN / PRODUCT

75°



TEKNİK ÇİZİM / TECHNICAL DRAWING

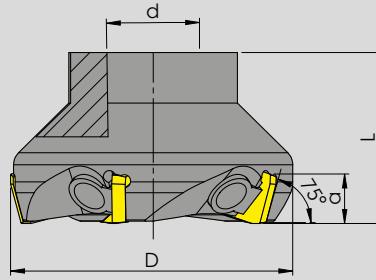

TAKIM KODU ORDERING CODE					TAKIM ÖLÇÜLERİ DIMENSIONS (mm)				KESİCİ UÇ ADET INSERT NUMBER	YEDEK PARÇALAR / SPARE PARTS				
										KESİCİ UÇ INSERT	BASKI VİDASI SCREW	BASKI PARÇASI WEDGE CLAMP	ALTLIK VİDASI SHIM SCREW	ANAHTAR ALLEN KEY
VRF75	SP12	D050	d22	Z04	D	d	L	A						
VRF75	SP12	D063	d22	Z05	50	22	40	5	4	SPKN 1204	VKP 002 M8	VRV 07 M6	AA4	
VRF75	SP12	D080	d27	Z06	63	22	40	5	5					
VRF75	SP12	D100	d32	Z08	80	27	50	5	6					
VRF75	SP12	D125	d40	Z10	100	32	50	5	8					
VRF75	SP12	D160	d40	Z12	125	40	62	5	10					
VRF75	SP12	D200	d60	Z14	160	40	62	5	12					
VRF75	SP12	D300	d60	Z20	200	60	62	5	14					
VRF75	SP12	D300	d60	Z20	300	60	65	5	20					

VRF90 AP16

ÜRÜN / PRODUCT

90°



TEKNİK ÇİZİM / TECHNICAL DRAWING

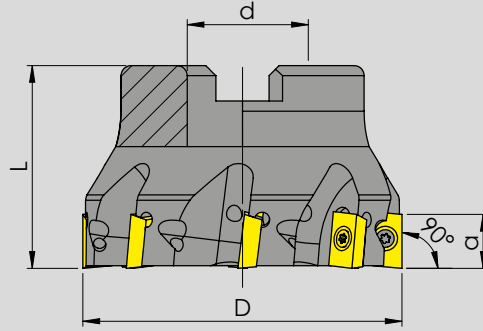

TAKIM KODU ORDERING CODE					TAKIM ÖLÇÜLERİ DIMENSIONS (mm)				KESİCİ UÇ ADET INSERT NUMBER	YEDEK PARÇALAR / SPARE PARTS				
										KESİCİ UÇ INSERT	BASKI VİDASI SCREW	ALTLIK SHIM	ALTLIK VİDASI SHIM SCREW	ANAHTAR TORX KEY
VRF90	AP16	D040	d16	Z04	D	d	L	A						
VRF90	AP16	D050	d22	Z05	40	16	40	13	4	APKT 1604	VRT 06 M3,5x9			T15
VRF90	AP16	D063	d22	Z06	50	22	40	13	5					
VRF90	AP16	D080	d27	Z07	63	22	40	13	6					
VRF90	AP16	D100	d32	Z08	80	27	50	13	7					
VRF90	AP16	D125	d40	Z09	100	32	50	13	8					
VRF90	AP16	D125	d40	Z09	125	40	60	13	9					
VRF90	AP16	D160	d40	Z10	160	40	60	13	10					

VRF90 AP10

ÜRÜN / PRODUCT

90°



TEKNİK ÇİZİM / TECHNICAL DRAWING

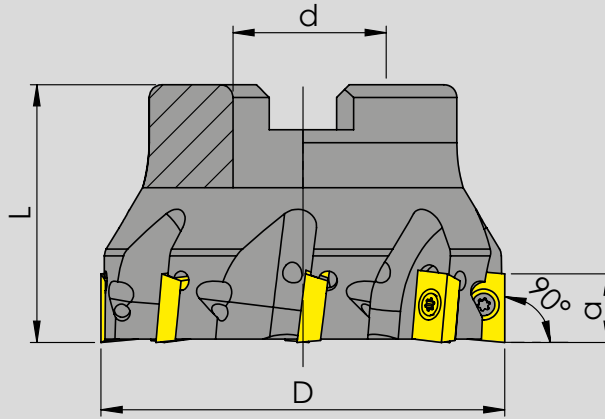

TAKIM KODU ORDERING CODE					TAKIM ÖLÇÜLERİ DIMENSIONS (mm)				KESİCİ UÇ ADET INSERT NUMBER	YEDEK PARÇALAR / SPARE PARTS				
										KESİCİ UÇ INSERT	BASKI VİDASI SCREW	ALTLIK SHIM	ALTLIK VİDASI SHIM SCREW	ANAHTAR TORX KEY
VRF90	AP10	D040	d16	Z06	40	16	40	8	6					
VRF90	AP10	D050	d22	Z07	50	22	40	8	7					
VRF90	AP10	D063	d22	Z08	63	22	40	8	8	APKT 1003	VRT 04 M2.5x7			T08
VRF90	AP10	D080	d27	Z10	80	27	50	8	10					
VRF90	AP10	D100	d32	Z12	100	32	50	8	12					

VRF RD10

ÜRÜN / PRODUCT



TEKNİK ÇİZİM / TECHNICAL DRAWING

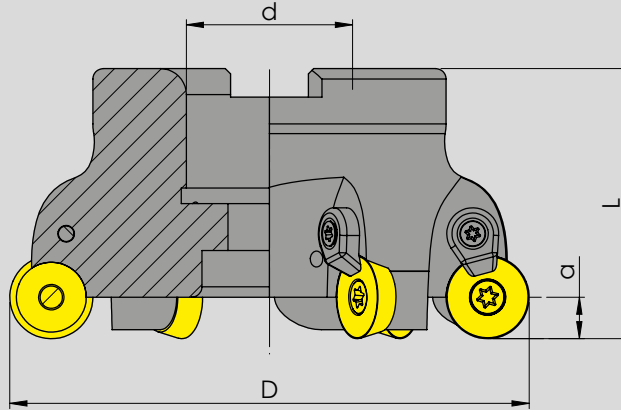

TAKIM KODU ORDERING CODE				TAKIM ÖLÇÜLERİ DIMENSIONS (mm)				KESİCİ UÇ ADET INSERT NUMBER	YEDEK PARÇALAR / SPARE PARTS				
									KESİCİ UÇ INSERT	BASKI PARÇASI WEDGE CLAMP	BASKI VİDASI SCREW	SIKMA VİDASI CLAMPING SCREW	ANAHTAR TORX KEY
				D	d	L	A						
VRF	RD1003	D040	d16 Z04	40	16	40	5	4	RD.. 10 03	VRV 11 M4	VRT 06 M3.5x9	T15	
VRF	RD1003	D050	d22 Z05	50	22	40	5	5					
VRF	RD1003	D063	d22 Z06	63	22	40	5	6					
VRF	RD1003	D080	d27 Z07	80	27	50	5	7					
VRF	RD1003	D100	d32 Z08	100	32	50	5	8					

VRF RD 12T03 ÜRÜN / PRODUCT



TEKNİK ÇİZİM / TECHNICAL DRAWING

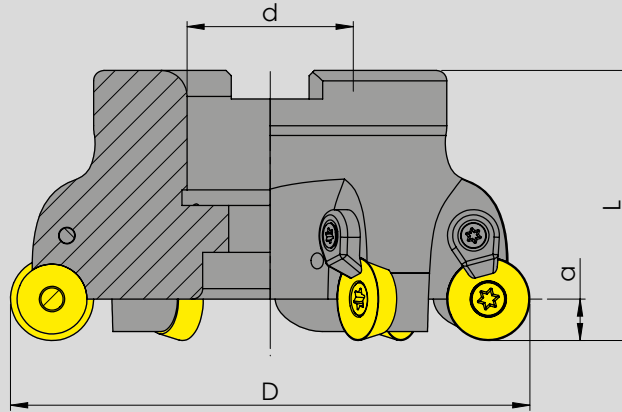

TAKIM KODU ORDERING CODE				TAKIM ÖLÇÜLERİ DIMENSIONS (mm)				KESİCİ UÇ ADET INSERT NUMBER	YEDEK PARÇALAR / SPARE PARTS				
									KESİCİ UÇ INSERT	BASKI PARÇASI WEDGE CLAMP	BASKI VIDASI SCREW	SIKMA VIDASI CLAMPING SCREW	ANAHTAR TORX KEY
VRF	RD12T03	D040	d16	Z04	D	d	L	A					
VRF	RD12T03	D050	d22	Z05	40	16	40	6	4	RD.. 12 T03	VRT 09 M4x11	VRT 06 M3,5x9	T15
VRF	RD12T03	D063	d22	Z06	50	22	40	6	5				
VRF	RD12T03	D080	d27	Z07	63	22	40	6	6				
VRF	RD12T03	D100	d32	Z08	80	27	50	6	7				
VRF	RD12T03	D100	d32	Z08	100	32	50	6	8				

VRF RD1204

ÜRÜN / PRODUCT



TEKNİK ÇİZİM / TECHNICAL DRAWING

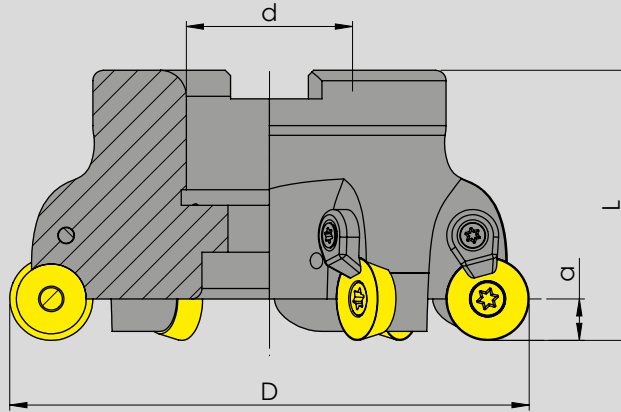

TAKIM KODU ORDERING CODE				TAKIM ÖLÇÜLERİ DIMENSIONS (mm)				KESİCİ UÇ ADET INSERT NUMBER	YEDEK PARÇALAR / SPARE PARTS					
									KESİCİ UÇ INSERT	BASKI PARÇASI WEDGE CLAMP	BASKI VIDASI SCREW	SIKMA VIDASI CLAMPING SCREW	ANAHTAR TORX KEY	
VRF	RD1204	D040	d16	Z04	D	d	L	A						
VRF	RD1204	D050	d22	Z05	40	16	40	6	4					
VRF	RD1204	D063	d22	Z06	50	22	40	6	5					
VRF	RD1204	D080	d27	Z07	63	22	40	6	6	RD.. 12 04	VCP 03	VRT 09 M4x11	VRT 06 M3,5x9	T15
VRF	RD1204	D100	d32	Z08	80	27	50	6	7					
VRF	RD1204	D100	d32	Z08	100	32	50	6	8					

VRF RD1604

ÜRÜN / PRODUCT



TEKNİK ÇİZİM / TECHNICAL DRAWING

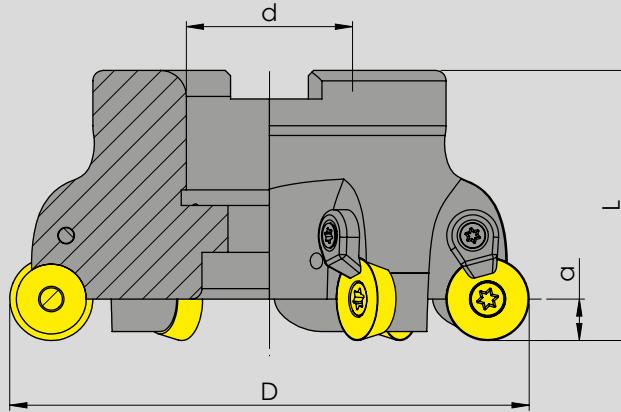

TAKIM KODU ORDERING CODE					TAKIM ÖLÇÜLERİ DIMENSIONS (mm)				KESİCİ UÇ ADET INSERT NUMBER	YEDEK PARÇALAR / SPARE PARTS				
										KESİCİ UÇ INSERT	BASKI PARÇASI WEDGE CLAMP	BASKI VIDASI SCREW	SIKMA VIDASI CLAMPING SCREW	ANAHTAR TORX KEY
					D	d	L	A						
VRF	RD1604	D063	d22	Z04	63	22	45	8	4					
VRF	RD1604	D080	d27	Z05	80	27	50	8	5	RD.. 16 04	VCP 04	VRT 12 M6x16	VRT 13 M5x12	T20
VRF	RD1604	D100	d32	Z06	100	32	50	8	6					
VRF	RD1604	D125	d40	Z07	125	40	65	8	7					

VRF WN09

ÜRÜN / PRODUCT



TEKNİK ÇİZİM / TECHNICAL DRAWING

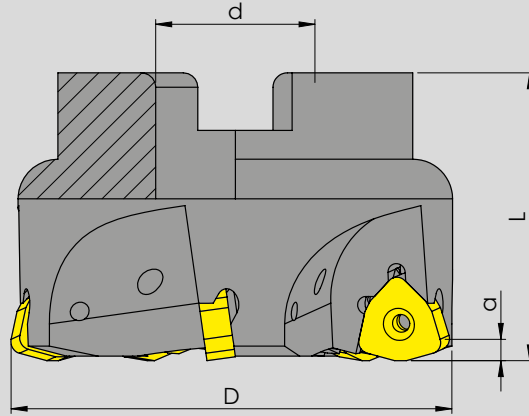

TAKIM KODU ORDERING CODE		TAKIM ÖLÇÜLERİ DIMENSIONS (mm)				KESİCİ UÇ ADET INSERT NUMBER	YEDEK PARÇALAR / SPARE PARTS							
							KESİCİ UÇ INSERT	BASKI PARÇASI WEDGE CLAMP	BASKI VİDASI SCREW	SIKMA VİDASI CLAMPING SCREW	ANAHTAR TORX KEY			
		D	d	L	A									
VRFWN	09	D050	d22	Z04	50	22	45	5	4	WNMX 09T3	VRT 05 M3x8	T10		
VRFWN	09	D052	d22	Z05	52	22	40	5	5					
VRFWN	09	D063	d22	Z05	63	22	45	5	5					
VRFWN	09	D066	d22	Z05	66	22	40	5	5					
VRFWN	09	D080	d27	Z06	80	27	52	5	6					
VRFWN	09	D100	d32	Z07	100	32	60	5	7					
VRFWN	13	D050	d22	Z04	50	22	45	6	4					
VRFWN	13	D063	d22	Z05	63	22	45	6	5	WNMX 1305	VCP 03	VRT 09 M4x11	VRT 09 M4x11	T15
VRFWN	13	D080	d27	Z06	80	27	52	6	6					
VRFWN	13	D100	d32	Z07	100	32	60	6	7					

VRF WD13

ÜRÜN / PRODUCT



TEKNİK ÇİZİM / TECHNICAL DRAWING

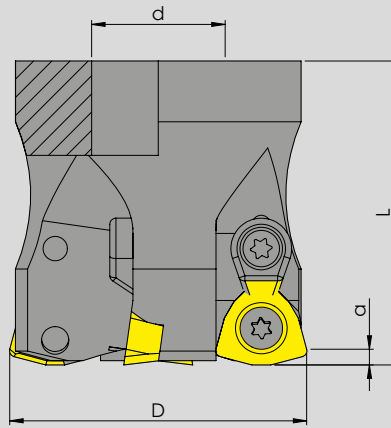

TAKIM KODU ORDERING CODE					TAKIM ÖLÇÜLERİ DIMENSIONS (mm)				KESİCİ UÇ ADET INSERT NUMBER	YEDEK PARÇALAR / SPARE PARTS				
										KESİCİ UÇ INSERT	BASKI PARÇASI WEDGE CLAMP	BASKI VİDASI SCREW	SIKMA VİDASI CLAMPING SCREW	ANAHTAR TORX KEY
VRFWD	13	D050	d22	Z04	D	d	L	A						
VRFWD	13	D063	d22	Z05	50	22	40	5	4	WDKT 1305	VCP 03	VRT 09 M4x11	VRT 13 M5x12	T15
VRFWD	13	D080	d27	Z06	63	22	40	5	5					
VRFWD	13	D100	d32	Z07	80	27	50	5	6					
VRFWD	13	D100	d32	Z07	100	32	65	5	7					

VRF90 LN15

ÜRÜN / PRODUCT

90°



TEKNİK ÇİZİM / TECHNICAL DRAWING

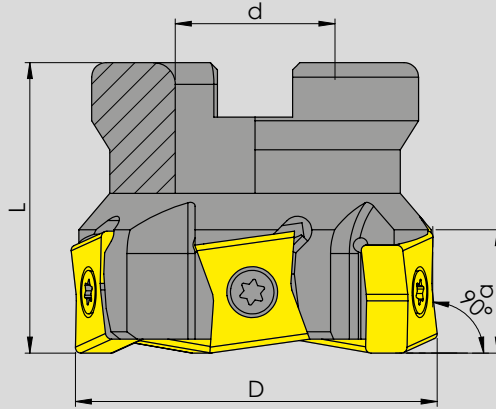

TAKIM KODU ORDERING CODE	TAKIM ÖLÇÜLERİ DIMENSIONS (mm)				KESİCİ UÇ ADET INSERT NUMBER	YEDEK PARÇALAR / SPARE PARTS				
	D	d	L	A		KESİCİ UÇ INSERT	BASKI PARÇASI WEDGE CLAMP	BASKI VIDASI SCREW	SIKMA VIDASI CLAMPING SCREW	ANAHTAR TORX KEY
VRF90LNR/L 15 D050 d22 Z05	50	22	40	5	5	LN.. 1506				
VRF90LNR/L 15 D063 d22 Z06	63	22	40	5	6					
VRF90LNR/L 15 D080 d27 Z07	80	27	50	5	7					
VRF90LNR/L 15 D100 d32 Z08	100	32	60	5	8					
VRF90LNR/L 15 D125 d40 Z09	125	40	65	5	9					
VRF90LNR/L 15 D160 d40 Z10	160	40	65	5	10					

VRF90 SE 12

ÜRÜN / PRODUCT

90°



TEKNİK ÇİZİM / TECHNICAL DRAWING

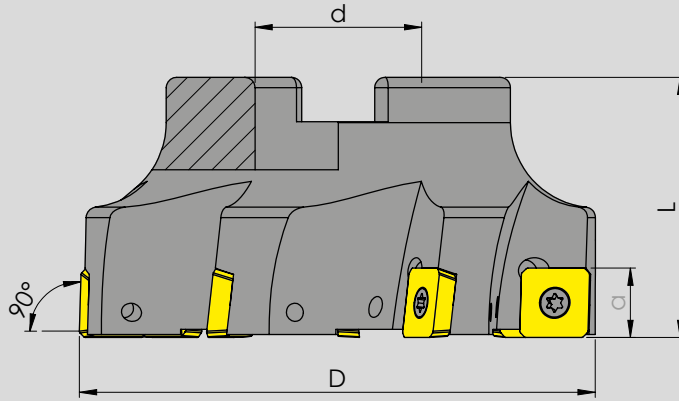

TAKIM KODU ORDERING CODE					TAKIM ÖLÇÜLERİ DIMENSIONS (mm)				KESİCİ UÇ ADET INSERT NUMBER	YEDEK PARÇALAR / SPARE PARTS				
										KESİCİ UÇ INSERT	BASKI PARÇASI WEDGE CLAMP	BASKI VİDASI SCREW	SIKMA VİDASI CLAMPING SCREW	ANAHTAR TORX KEY
VRF90	SE1203	D050	d22	Z04	D	d	L	A						
VRF90	SE1203	D063	d22	Z05	50	22	40	8	4	SEET 12 03			VRT 06 M3,5x9	T15
VRF90	SE1203	D080	d27	Z06	63	22	40	8	5					
VRF90	SE1203	D100	d32	Z07	80	27	50	8	6					
VRF90	SE1203	D100	d32	Z07	100	32	65	8	7					

VRF45 SE12T3



ÜRÜN / PRODUCT

45°

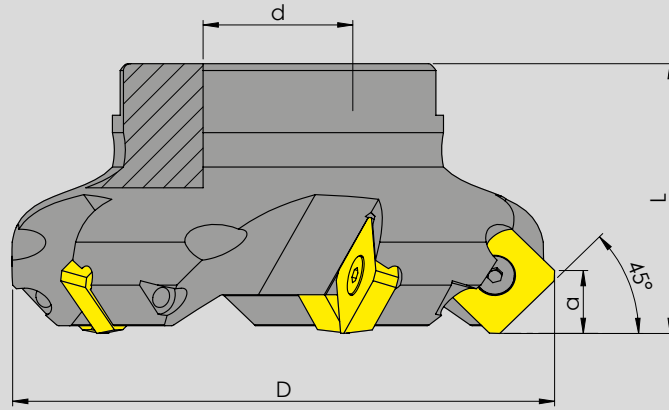

TEKNİK ÇİZİM / TECHNICAL DRAWING



TAKIM KODU ORDERING CODE					TAKIM ÖLÇÜLERİ DIMENSIONS (mm)				KESİCİ UÇ ADET INSERT NUMBER	YEDEK PARÇALAR / SPARE PARTS				
										KESİCİ UÇ INSERT	BASKI PARÇASI WEDGE CLAMP	BASKI VIDASI SCREW	SIKMA VIDASI CLAMPING SCREW	ANAHTAR TORX KEY
					D	d	L	A						
VRF45	SE12T3	D050	d22	Z04	50	22	40	6	4					
VRF45	SE12T3	D063	d22	Z05	63	22	40	6	5					
VRF45	SE12T3	D080	d27	Z06	80	27	50	6	6	SEET 12 T3			VRT 06 M3,5x9	T15
VRF45	SE12T3	D100	d32	Z07	100	32	50	6	7					
VRF45	SE12T3	D125	d40	Z08	125	40	62	6	8					
VRF45	SE12T3	D160	d40	Z10	160	40	62	6	10					

VRF45 OD06

ÜRÜN / PRODUCT

45°



TEKNİK ÇİZİM / TECHNICAL DRAWING

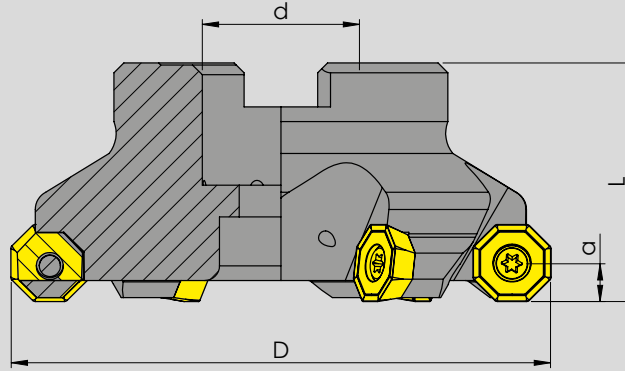

TAKIM KODU ORDERING CODE				TAKIM ÖLÇÜLERİ DIMENSIONS (mm)				KESİCİ UÇ ADET INSERT NUMBER	YEDEK PARÇALAR / SPARE PARTS				
									KESİCİ UÇ INSERT	BASKI PARÇASI WEDGE CLAMP	BASKI VIDASI SCREW	SIKMA VIDASI CLAMPING SCREW	ANAHTAR TORX KEY
				D	d	L	A						
VRF45	OD06	D050	d22 Z04	50	22	40	4	4	OD.. 06 05				
VRF45	OD06	D063	d22 Z05	63	22	40	4	5					
VRF45	OD06	D080	d27 Z06	80	27	50	4	6					
VRF45	OD06	D100	d32 Z07	100	32	50	4	7					
VRF45	OD06	D125	d40 Z08	125	40	60	4	8					
VRF45	OD06	D160	d40 Z09	160	40	60	4	9					
VRF45	OD06	D200	d60 Z12	200	60	60	4	12					

VRF45 PN12

ÜRÜN / PRODUCT

45°



TEKNİK ÇİZİM / TECHNICAL DRAWING

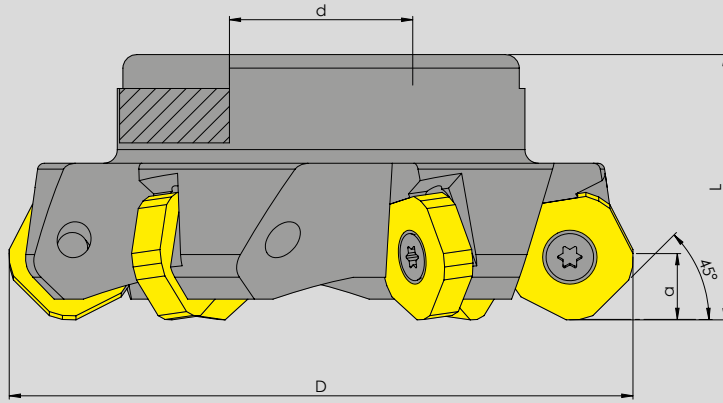

TAKIM KODU ORDERING CODE					TAKIM ÖLÇÜLERİ DIMENSIONS (mm)				KESİCİ UÇ ADET INSERT NUMBER	YEDEK PARÇALAR / SPARE PARTS				
										KESİCİ UÇ INSERT	BASKI PARÇASI WEDGE CLAMP	BASKI VİDASI SCREW	SIKMA VİDASI CLAMPING SCREW	ANAHTAR TORX KEY
VRF45	PN12	D063	d22	Z05	63	22	40	4	5					
VRF45	PN12	D080	d27	Z06	80	27	50	4	6	PN.. 12 05			VRT 13 M5x12	T20
VRF45	PN12	D100	d32	Z07	100	32	50	4	7					

VRF45 SN 1205

ÜRÜN / PRODUCT

45°



TEKNİK ÇİZİM / TECHNICAL DRAWING

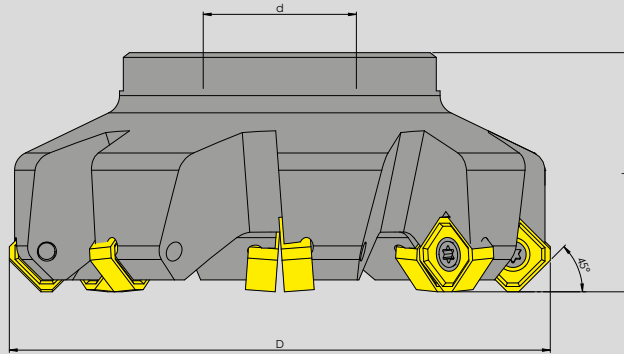

TAKIM KODU ORDERING CODE					TAKIM ÖLÇÜLERİ DIMENSIONS (mm)				KESİCİ UÇ ADET INSERT NUMBER	YEDEK PARÇALAR / SPARE PARTS				
										KESİCİ UÇ INSERT	BASKI PARÇASI WEDGE CLAMP	BASKI VIDASI SCREW	SIKMA VIDASI CLAMPING SCREW	ANAHTAR TORX KEY
VRF45	SN1205	D050	d22	Z05	D	d	L	A						
VRF45	SN1205	D063	d22	Z06	63	22	40	6	5	SNMX 1205			VRT 09 M4x11	
VRF45	SN1205	D080	d27	Z07	80	27	50	6	6					
VRF45	SN1205	D100	d32	Z08	100	32	50	6	7					
VRF45	SN1205	D125	d40	Z10	125	40	62	6	8					
VRF45	SN1205	D160	d40	Z12	160	40	62	6	10					
VRF45	SN1205	D160	d40	Z12	160	40	62	6	12					

VRF88 SN 1205

ÜRÜN / PRODUCT

88°



TEKNİK ÇİZİM / TECHNICAL DRAWING

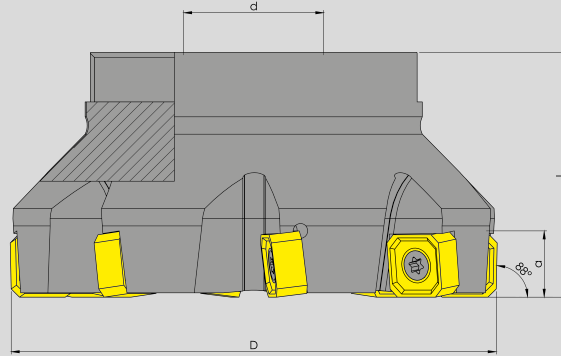

TAKIM KODU ORDERING CODE					TAKIM ÖLÇÜLERİ DIMENSIONS (mm)				KESİCİ UÇ ADET INSERT NUMBER	YEDEK PARÇALAR / SPARE PARTS				
										KESİCİ UÇ INSERT	BASKI PARÇASI WEDGE CLAMP	BASKI VIDASI SCREW	SIKMA VIDASI CLAMPING SCREW	ANAHTAR TORX KEY
					D	d	L	A						
VRF88	SN1205	D050	d22	Z05	50	22	40	6	5	SNMX 1205		VRT 09 M4x11	T15	
VRF88	SN1205	D063	d22	Z06	63	22	40	6	6					
VRF88	SN1205	D080	d27	Z07	80	27	50	6	7					
VRF88	SN1205	D080	d27	Z09	80	27	50	6	9					
VRF88	SN1205	D100	d32	Z08	100	32	50	6	8					
VRF88	SN1205	D125	d40	Z10	125	40	62	6	10					

VRF88 SN 1206

ÜRÜN / PRODUCT

88°



TEKNİK ÇİZİM / TECHNICAL DRAWING

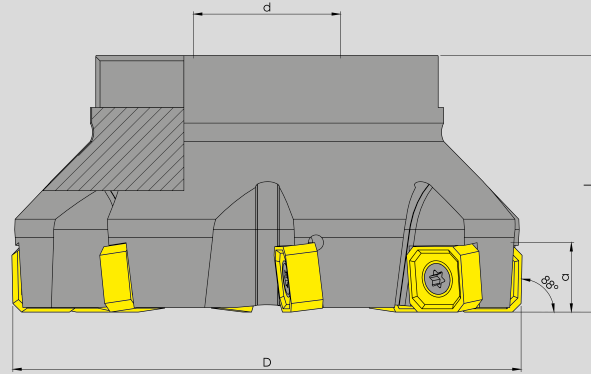

TAKIM KODU ORDERING CODE					TAKIM ÖLÇÜLERİ DIMENSIONS (mm)				KESİCİ UÇ ADET INSERT NUMBER	YEDEK PARÇALAR / SPARE PARTS				
										KESİCİ UÇ INSERT	BASKI PARÇASI WEDGE CLAMP	BASKI VIDASI SCREW	SIKMA VIDASI CLAMPING SCREW	ANAHTAR TORX KEY
					D	d	L	A						
VRF88	SN1206	D050	d22	Z05	50	22	40	6	5	SNMX 1206			T15	
VRF88	SN1206	D063	d22	Z06	63	22	40	6	6					
VRF88	SN1206	D080	d27	Z07	80	27	50	6	7					
VRF88	SN1206	D100	d32	Z08	100	32	50	6	8					
VRF88	SN1206	D125	d40	Z10	125	40	62	6	10					
VRF88	SN1206	D160	d40	Z12	160	40	62	6	12					

VRF90 AP1135





ÜRÜN / PRODUCT

90°

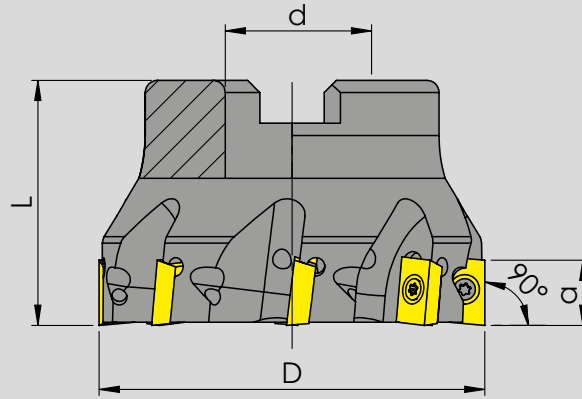

TEKNİK ÇİZİM / TECHNICAL DRAWING



TAKIM KODU ORDERING CODE					TAKIM ÖLÇÜLERİ DIMENSIONS (mm)				KESİCİ UÇ ADET INSERT NUMBER	YEDEK PARÇALAR / SPARE PARTS				
										KESİCİ UÇ INSERT	BASKI PARÇASI WEDGE CLAMP	BASKI VİDASI SCREW	SIKMA VİDASI CLAMPING SCREW	ANAHTAR TORX KEY
					D	d	L	A						
VRF90	AP1135	D040	d16	Z06	40	16	40	9	6					
VRF90	AP1135	D050	d22	Z07	50	22	40	9	7	AP. 1135			VRT 04 M2,5x7	T08
VRF90	AP1135	D063	d22	Z08	63	22	40	9	8					

VRF90 AP11 R390

ÜRÜN / PRODUCT

90°



TEKNİK ÇİZİM / TECHNICAL DRAWING

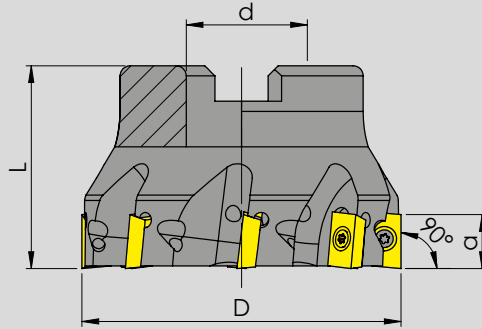

TAKIM KODU ORDERING CODE					TAKIM ÖLÇÜLERİ DIMENSIONS (mm)				KESİCİ UÇ ADET INSERT NUMBER	YEDEK PARÇALAR / SPARE PARTS				
										KESİCİ UÇ INSERT	BASKI PARÇASI WEDGE CLAMP	BASKI VİDASI SCREW	SIKMA VİDASI CLAMPING SCREW	ANAHTAR TORX KEY
VRF90	AP11R390	D040	d16	Z05	40	16	40	9	5	AP. 11 R390				T08
VRF90	AP11R390	D050	d22	Z06	50	22	40	9	6					
VRF90	AP11R390	D063	d22	Z07	63	22	40	9	7					
VRF90	AP11R390	D080	d27	Z08	80	27	50	9	8					
VRF90	AP17R390	D040	d16	Z04	40	16	40	14	4	AP. 17 R390				T15
VRF90	AP17R390	D050	d22	Z05	50	22	40	14	5					
VRF90	AP17R390	D063	d22	Z06	63	22	40	14	6					
VRF90	AP17R390	D080	d27	Z07	80	27	50	14	7					
VRF90	AP17R390	D100	d32	Z08	100	32	50	14	8					
VRF90	AP17R390	D125	d40	Z09	125	40	60	14	9					
VRF90	AP18R390	D040	d16	Z03	40	16	40	15	3	AP. 18 R390				T15
VRF90	AP18R390	D050	d22	Z04	50	22	40	15	4					
VRF90	AP18R390	D063	d22	Z05	63	22	40	15	5					
VRF90	AP18R390	D080	d27	Z06	80	27	50	15	6					
VRF90	AP18R390	D100	d32	Z07	100	32	60	15	7					
VRF90	AP18R390	D125	d40	Z08	125	40	60	15	8					

VRF90 AX17

ÜRÜN / PRODUCT

90°



TEKNİK ÇİZİM / TECHNICAL DRAWING

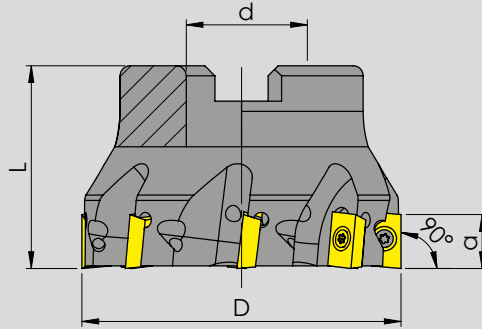

TAKIM KODU ORDERING CODE	TAKIM ÖLÇÜLERİ DIMENSIONS (mm)				KESİCİ UÇ ADET INSERT NUMBER	YEDEK PARÇALAR / SPARE PARTS				
	D	d	L	A		KESİCİ UÇ INSERT	BASKI PARÇASI WEDGE CLAMP	BASKI VİDASI SCREW	SIKMA VİDASI CLAMPING SCREW	ANAHTAR TORX KEY
VRF90 AX17 D040 d16 Z04	40	16	40	15	4					
VRF90 AX17 D050 d22 Z05	50	22	40	15	5	AX.. 1705			VRT 09 M4x11	T15
VRF90 AX17 D063 d22 Z06	63	22	40	15	6					
VRF90 AX17 D080 d27 Z07	80	27	50	15	7					

VRF90 LN..13

ÜRÜN / PRODUCT

90°



TEKNİK ÇİZİM / TECHNICAL DRAWING

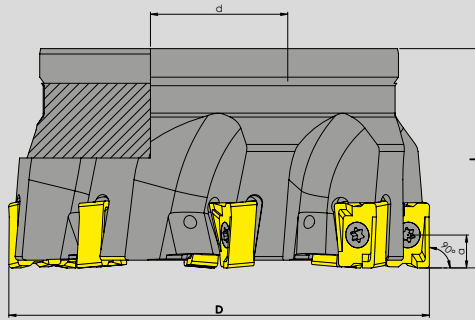

TAKIM KODU ORDERING CODE	TAKIM ÖLÇÜLERİ DIMENSIONS (mm)				KESİCİ UÇ ADET INSERT NUMBER	YEDEK PARÇALAR / SPARE PARTS				
	D	d	L	A		KESİCİ UÇ INSERT	BASKI PARÇASI WEDGE CLAMP	BASKI VİDASI SCREW	SIKMA VİDASI CLAMPING SCREW	ANAHTAR TORX KEY
VRF90 LN13 D063 d22 Z06	63	22	40	12	6	LN.. 1307				
VRF90 LN13 D080 d27 Z07	80	27	50	12	7					
VRF90 LN13 D100 d32 Z08	100	32	50	12	8					
VRF90 LN13 D125 d40 Z10	125	40	60	12	10					

VRF RP

ÜRÜN / PRODUCT



TEKNİK ÇİZİM / TECHNICAL DRAWING

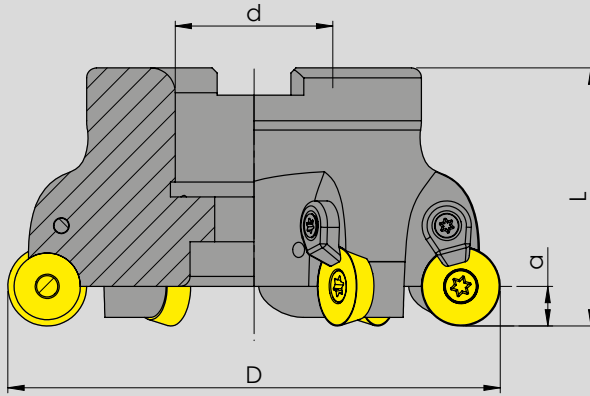

TAKIM KODU ORDERING CODE					TAKIM ÖLÇÜLERİ DIMENSIONS (mm)				KESİCİ UÇ ADET INSERT NUMBER	YEDEK PARÇALAR / SPARE PARTS				
					D	d	L	A		KESİCİ UÇ INSERT	BASKI PARÇASI WEDGE CLAMP	BASKI VIDASI SCREW	SIKMA VIDASI CLAMPING SCREW	ANAHTAR TORX KEY
VRF	RP10	D040	d16	Z04	40	16	40	5	4	RP. 10 03				T15
VRF	RP10	D050	d22	Z05	50	22	40	5	5					
VRF	RP10	D063	d22	Z06	63	22	40	5	6					
VRF	RP10	D080	d27	Z07	80	27	50	5	7					
VRF	RP10	D100	d32	Z08	100	32	50	5	8					
VRF	RP12	D040	d16	Z04	40	16	40	5	4	RP. 12 04	VCP 03	VRT 09 M4x11		T15
VRF	RP12	D050	d22	Z05	50	22	40	5	5					
VRF	RP12	D063	d22	Z06	63	22	40	5	6					
VRF	RP12	D080	d27	Z07	80	27	50	5	7					
VRF	RP12	D100	d32	Z08	100	32	50	5	8					

VRF90 C TP22

ÜRÜN / PRODUCT

90°



TEKNİK ÇİZİM / TECHNICAL DRAWING

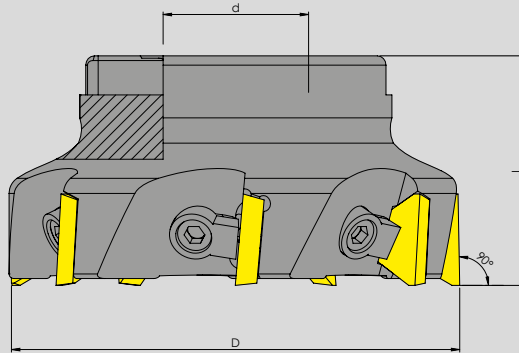

TAKIM KODU ORDERING CODE					TAKIM ÖLÇÜLERİ DIMENSIONS (mm)				KESİCİ UÇ ADET INSERT NUMBER	YEDEK PARÇALAR / SPARE PARTS				
										KESİCİ UÇ INSERT	BASKI BARÇASI WEDGE CLAMP	BASKI VIDASI SCREW	ALTLIK VIDASI SHIM SCREW	ANAHTAR ALLEN KEY
					D	d	L	A						
VRF90C	TP22	D063	d22	Z05	63	22	40	18	5	TP. 22 04	VTP 001	VKP 002 M8	VSP 01 M8	AA4
VRF90C	TP22	D080	d27	Z06	80	27	50	18	6					
VRF90C	TP22	D100	d32	Z07	100	32	50	18	7					
VRF90C	TP22	D125	d40	Z08	125	40	62	18	8					
VRF90C	TP22	D160	d40	Z09	160	40	62	18	9					

VRFJD12

ÜRÜN / PRODUCT



TEKNİK ÇİZİM / TECHNICAL DRAWING

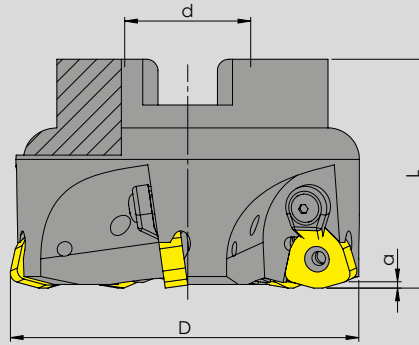

TAKIM KODU ORDERING CODE					TAKIM ÖLÇÜLERİ DIMENSIONS (mm)				KESİCİ UÇ ADET INSERT NUMBER	YEDEK PARÇALAR / SPARE PARTS				
										KESİCİ UÇ INSERT	BASKI BARÇASI WEDGE CLAMP	BASKI VIDASI SCREW	ALTLIK VIDASI SHIM SCREW	ANAHTAR TORX KEY
					D	d	L	A						
VRFJD	JD1204	D050	d22	Z04	50	22	40	2	4					
VRFJD	JD1204	D063	d22	Z05	63	22	40	2	5	JD.. 12 04	VCP 03	VRT 09 M4x11	VRT 09 M4x11	T15
VRFJD	JD1204	D080	d27	Z06	80	27	50	2	6					

VRF45 SP12

ÜRÜN / PRODUCT

45°



TEKNİK ÇİZİM / TECHNICAL DRAWING

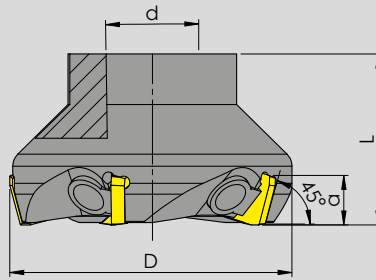

TAKIM KODU ORDERING CODE					TAKIM ÖLÇÜLERİ DIMENSIONS (mm)				KESİCİ UÇ ADET INSERT NUMBER	YEDEK PARÇALAR / SPARE PARTS				
										KESİCİ UÇ INSERT	BASKI BARÇASI WEDGE CLAMP	BASKI VİDASI SCREW	ALTLIK VİDASI SHIM SCREW	ANAHTAR ALLEN KEY
VRF45	SEK12	D050	d22	Z04	D	d	L	A						
VRF45	SEK12	D063	d22	Z05	50	22	40	5	4	SEKN 1203	VKP 002 M8	VRV 07 M8		AA4
VRF45	SEK12	D080	d27	Z06	63	22	40	5	5					
VRF45	SEK12	D100	d32	Z08	80	27	50	5	6					
VRF45	SEK12	D100	d32	Z08	100	32	50	5	8					

VRF90 SD 09T3

ÜRÜN / PRODUCT

90°



TEKNİK ÇİZİM / TECHNICAL DRAWING

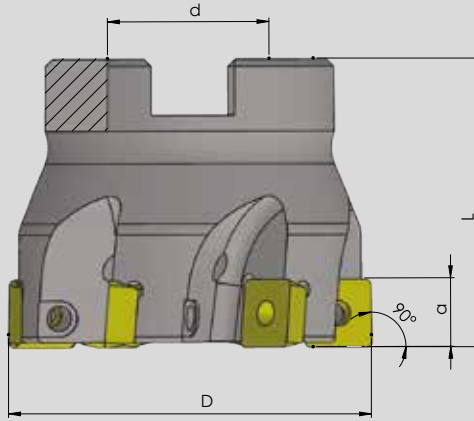

TAKIM KODU ORDERING CODE					TAKIM ÖLÇÜLERİ DIMENSIONS (mm)				KESİCİ UÇ ADET INSERT NUMBER	YEDEK PARÇALAR / SPARE PARTS					
										KESİCİ UÇ INSERT	BASKI PARÇASI WEDGE CLAMP	BASKI VİDASI SCREW	SIKMA VİDASI CLAMPING SCREW	ANAHTAR TORX KEY	
VRF90	SD09T3	D040	d16	Z05	D	d	L	A							
VRF90	SD09T3	D050	d22	Z06	50	22	40	9	5	SD.. 09 T3				VRT 06 M3,5x9	T15
VRF90	SD09T3	D063	d22	Z07	63	22	40	9	6						
VRF90	SD09T3	D080	d27	Z08	80	27	50	9	7						
VRF90	SD1204	D080	d27	Z06	80	27	50	12	8	SD.. 1204				VRT 09 M4x11	T15
VRF90	SD1204	D100	d32	Z07	100	32	50	12	6						



The red power for
the professionals
Profesyoneller için
KIRMIZI GÜÇ



PARMAK
FREZE TAKIMLARI
End milling toolholders

www.vorgen.com

SPAP 16





ÜRÜN / PRODUCT

90°

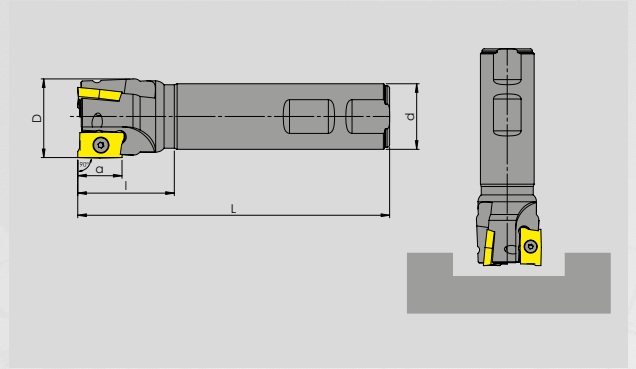

TEKNİK ÇİZİM / TECHNICAL DRAWING



TAKIM KODU ORDERING CODE		TAKIM ÖLÇÜLERİ DIMENSIONS (mm)			KESİCİ UÇ ADET INSERT NUMBER	KESİCİ UÇ INSERT	YEDEK PARÇALAR / SPARE PARTS	
							BASKI VIDASI SCREW	ANAHTAR TORX KEY
		D	d	L				
SPAP16	S02 D25 d25 L100	25	25	100	2			
SPAP16	S02 D30 d25 L100	30	25	100	2			
SPAP16	S03 D32 d25 L100	32	25	100	3			
SPAP16	S03 D35 d25 L100	35	25	100	3			
SPAP16	S03 D40 d32 L100	40	32	100	3			
SPAP16	S04 D45 d32 L100	45	32	100	4			
SPAP16	S04 D50 d32 L100	50	32	100	4			
SPAP16	S02 D25 d25 L120	25	25	120	2			
SPAP16	S02 D30 d25 L120	30	25	120	2			
SPAP16	S03 D32 d25 L120	32	25	120	3			
SPAP16	S03 D35 d25 L120	35	25	120	3			
SPAP16	S03 D40 d32 L120	40	32	120	3			
SPAP16	S04 D45 d32 L120	45	32	120	4			
SPAP16	S05 D50 d32 L120	50	32	120	5			
SPAP16	S02 D25 d25 L150	25	25	150	2	APKT 1604	VRT 09 M4x11	T15
SPAP16	S02 D30 d25 L150	30	25	150	2			
SPAP16	S03 D32 d25 L150	32	25	150	3			
SPAP16	S03 D35 d25 L150	35	25	150	3			
SPAP16	S03 D40 d32 L150	40	32	150	3			
SPAP16	S04 D45 d32 L150	45	32	150	4			
SPAP16	S05 D50 d32 L150	50	32	150	5			
SPAP16	S02 D25 d25 L200	25	25	200	2			
SPAP16	S02 D30 d25 L200	30	25	200	2			
SPAP16	S03 D32 d25 L200	32	25	200	3			
SPAP16	S03 D35 d25 L200	35	25	200	3			
SPAP16	S03 D40 d32 L200	40	32	200	3			
SPAP16	S04 D45 d32 L200	45	32	200	4			
SPAP16	S05 D50 d32 L200	50	32	200	5			

SPSD 09

ÜRÜN / PRODUCT

90°



TEKNİK ÇİZİM / TECHNICAL DRAWING

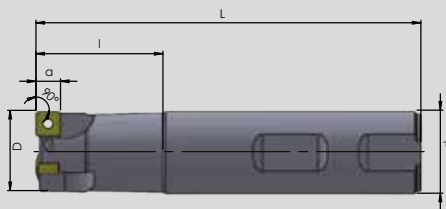

TAKIM KODU ORDERING CODE		TAKIM ÖLÇÜLERİ DIMENSIONS (mm)			KESİCİ UÇ ADET INSERT NUMBER	KESİCİ UÇ INSERT	YEDEK PARÇALAR / SPARE PARTS	
							BASKI VIDASI SCREW	ANAHTAR TORX KEY
SPSD 09	S02 D20 d20 L150	D	d	L		SD..09T3		
SPSD 09	S02 D25 d25 L150	20	20	150	2		VRT 06 M3,5x9	T15
SPSD 09	S02 D28 d25 L150	25	25	150	2			
SPSD 09	S02 D28 d25 L150	28	25	150	2			
SPSD 09	S03 D32 d25 L150	32	25	150	3			

SPAP 10

ÜRÜN / PRODUCT





90°

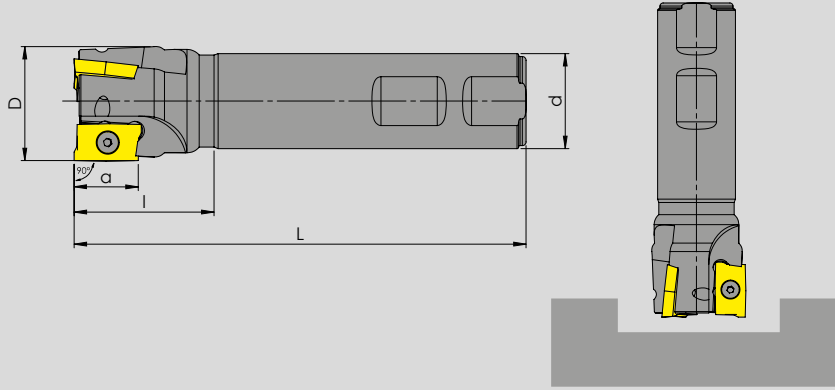

TEKNİK ÇİZİM / TECHNICAL DRAWING



TAKIM KODU ORDERING CODE		TAKIM ÖLÇÜLERİ DIMENSIONS (mm)			KESİCİ UÇ ADET INSERT NUMBER	KESİCİ UÇ INSERT	YEDEK PARÇALAR / SPARE PARTS	
							BASKI VİDASI SCREW	ANAHTAR TORX KEY
SPAP10	S01 D10 d10 L100	D	d	L		APKT 1003		
SPAP10	S01 D12 d12 L100	10	10	100	1		VRT 04 M2,5x7	T08
SPAP10	S01 D14 d14 L100	12	12	100	1			
SPAP10	S02 D16 d16 L100	14	14	100	1			
SPAP10	S02 D18 d16 L100	16	16	100	2			
SPAP10	S02 D18 d16 L100	18	16	100	2			
SPAP10	S03 D20 d20 L100	20	20	100	3			
SPAP10	S03 D22 d20 L100	22	20	100	3			
SPAP10	S03 D25 d25 L100	25	25	100	3			
SPAP10	S03 D28 d25 L100	28	25	100	3			
SPAP10	S04 D30 d25 L100	30	25	100	4			
SPAP10	S04 D32 d25 L100	32	25	100	4			
SPAP10	S04 D35 d25 L100	35	25	100	4			

TAKIM KODU ORDERING CODE		TAKIM ÖLÇÜLERİ DIMENSIONS (mm)			KESİCİ UÇ ADET INSERT NUMBER	KESİCİ UÇ INSERT	YEDEK PARÇALAR / SPARE PARTS	
							BASKI VIDASI SCREW	ANAHTAR TORX KEY
		D	d	L				
SPAP10	S01 D10 d10 L120	10	10	120	1	APKT 1003	VRT 04 M2,5x7	T08
SPAP10	S01 D12 d12 L120	12	12	120	1			
SPAP10	S01 D14 d14 L120	14	14	120	1			
SPAP10	S02 D16 d16 L120	16	16	120	2			
SPAP10	S02 D18 d16 L120	18	16	120	2			
SPAP10	S03 D20 d20 L120	20	20	120	3			
SPAP10	S03 D22 d20 L120	22	20	120	3			
SPAP10	S03 D25 d25 L120	25	25	120	3			
SPAP10	S03 D28 d25 L120	28	25	120	3			
SPAP10	S04 D30 d25 L120	30	25	120	4			
SPAP10	S04 D32 d25 L120	32	25	120	4			
SPAP10	S04 D35 d25 L120	35	25	120	4			
SPAP10	S05 D40 d32 L120	40	32	120	5			
SPAP10	S01 D10 d10 L150	10	10	150	1			
SPAP10	S01 D12 d12 L150	12	12	150	1			
SPAP10	S01 D14 d14 L150	14	14	150	1			
SPAP10	S02 D16 d16 L150	16	16	150	2			
SPAP10	S02 D18 d16 L150	18	16	150	2			
SPAP10	S03 D20 d20 L150	20	20	150	3			
SPAP10	S03 D22 d20 L150	22	20	150	3			
SPAP10	S03 D25 d25 L150	25	25	150	3			
SPAP10	S03 D28 d25 L150	28	25	150	3			
SPAP10	S04 D30 d25 L150	30	25	150	4			
SPAP10	S04 D32 d25 L150	32	25	150	4			
SPAP10	S04 D35 d25 L150	35	25	150	4			
SPAP10	S05 D40 d32 L150	40	32	150	5			
SPAP10	S02 D16 d16 L200	16	16	200	2			
SPAP10	S02 D18 d16 L200	18	16	200	2			
SPAP10	S03 D20 d20 L200	20	20	200	3			
SPAP10	S03 D22 d20 L200	22	20	200	3			
SPAP10	S03 D25 d25 L200	25	25	200	3			
SPAP10	S03 D28 d25 L200	28	25	200	3			
SPAP10	S04 D30 d25 L200	30	25	200	4			
SPAP10	S04 D32 d25 L200	32	25	200	4			
SPAP10	S04 D35 d25 L200	35	25	200	4			
SPAP10	S05 D40 d32 L200	40	32	200	5			
SPAP10	S02 D16 d16 L250	16	16	250	2			
SPAP10	S02 D18 d16 L250	18	16	250	2			
SPAP10	S03 D20 d20 L250	20	20	250	3			
SPAP10	S03 D25 d25 L250	25	25	250	3			





SPRD 10

ÜRÜN / PRODUCT

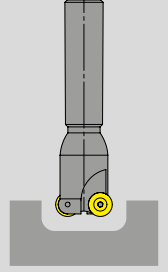
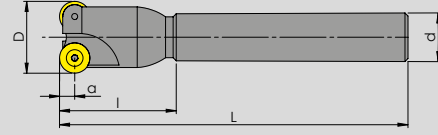

TEKNİK ÇİZİM / TECHNICAL DRAWING



TAKIM KODU ORDERING CODE		TAKIM ÖLÇÜLERİ DIMENSIONS (mm)			KESİCİ UÇ ADET INSERT NUMBER	KESİCİ UÇ INSERT	YEDEK PARÇALAR / SPARE PARTS	
							BASKI VIDASI SCREW	ANAHTAR ALLEN KEY
		D	d	L				
SPRD1204	S02 D25 d25 L120	25	25	120	2	RD.. 1204	VRT 09 M4x11	T15
SPRD1204	S02 D28 d25 L120	28	25	120	2			
SPRD1204	S02 D30 d25 L120	30	25	120	2			
SPRD1204	S03 D32 d25 L120	32	25	120	3			
SPRD1204	S03 D35 d32 L120	35	32	120	3			
SPRD1204	S03 D40 d32 L120	40	32	120	3			
SPRD1204	S02 D25 d25 L150	25	25	150	2			
SPRD1204	S02 D28 d25 L150	28	25	150	2			
SPRD1204	S02 D30 d25 L150	30	25	150	2			
SPRD1204	S03 D32 d25 L150	32	25	150	3			
SPRD1204	S03 D35 d32 L150	35	32	150	3			
SPRD1204	S03 D40 d32 L150	40	32	150	3			
SPRD1204	S02 D25 d25 L200	25	25	200	2			
SPRD1204	S02 D28 d25 L200	28	25	200	2			
SPRD1204	S02 D30 d25 L200	30	25	200	2			
SPRD1204	S03 D32 d25 L200	32	25	200	3			
SPRD1204	S03 D35 d32 L200	35	32	200	3			
SPRD1204	S03 D40 d32 L200	40	32	200	3			

TAKIM KODU ORDERING CODE		TAKIM ÖLÇÜLERİ DIMENSIONS (mm)			KESİCİ UÇ ADET INSERT NUMBER	KESİCİ UÇ INSERT	YEDEK PARÇALAR / SPARE PARTS	
							BASKI VİDASI SCREW	ANAHTAR TORX KEY
		D	d	L				
SPRD1003	S02 D20 d20 L120	20	20	120	2	RD.. 1003	VRT 06 M3,5x9	T15
SPRD1003	S02 D25 d25 L120	25	25	120	2			
SPRD1003	S03 D28 d25 L120	28	25	120	3			
SPRD1003	S03 D30 d25 L120	30	25	120	3			
SPRD1003	S03 D32 d25 L120	32	25	120	3			
SPRD1003	S03 D35 d25 L120	35	25	120	3			
SPRD1003	S03 D35 d32 L120	35	32	120	3			
SPRD1003	S04 D40 d32 L120	40	32	120	4			
SPRD1003	S02 D20 d20 L150	20	20	150	2			
SPRD1003	S02 D25 d25 L150	25	25	150	2			
SPRD1003	S03 D28 d25 L150	28	25	150	3			
SPRD1003	S03 D30 d25 L150	30	25	150	3			
SPRD1003	S03 D32 d25 L150	32	25	150	3			
SPRD1003	S03 D35 d25 L150	35	25	150	3			
SPRD1003	S03 D35 d32 L150	35	32	150	3			
SPRD1003	S04 D40 d32 L150	40	32	150	4			
SPRD1003	S02 D20 d20 L200	20	20	200	2			
SPRD1003	S02 D25 d25 L200	25	25	200	2			
SPRD1003	S03 D28 d25 L200	28	25	200	3			
SPRD1003	S03 D30 d25 L200	30	25	200	3			
SPRD1003	S03 D32 d25 L200	32	25	200	3			
SPRD1003	S03 D35 d25 L200	35	25	200	3			
SPRD1003	S03 D35 d32 L200	35	32	200	3			
SPRD1003	S04 D40 d32 L200	40	32	200	4			
SPRD1003	S02 D20 d20 L250	20	20	250	2			
SPRD1003	S02 D25 d25 L250	25	25	250	2			





SPRP

ÜRÜN / PRODUCT

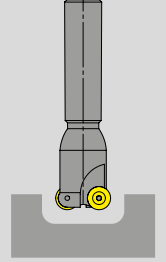
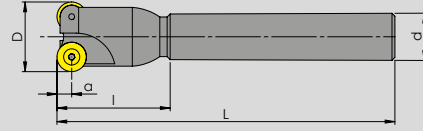

TEKNİK ÇİZİM / TECHNICAL DRAWING



TAKIM KODU ORDERING CODE		TAKIM ÖLÇÜLERİ DIMENSIONS (mm)			KESİCİ UÇ ADET INSERT NUMBER	KESİCİ UÇ INSERT	YEDEK PARÇALAR / SPARE PARTS	
							BASKI VIDASI SCREW	ANAHTAR TORX KEY
		D	d	L				
SPRP 1003	S02 D20 d20 L120	20	20	120	2	RP. 1003	VRT 06 M3,5x9	T15
SPRP 1003	S02 D25 d25 L120	25	25	120	2			
SPRP 1003	S03 D30 d25 L120	30	25	120	3			
SPRP 1003	S03 D32 d25 L120	32	25	120	3			
SPRP 1003	S03 D35 d32 L120	35	32	120	3			
SPRP 1003	S02 D20 d20 L150	20	20	150	2			
SPRP 1003	S02 D25 d25 L150	25	25	150	2			
SPRP 1003	S03 D30 d25 L150	30	25	150	3			
SPRP 1003	S03 D32 d25 L150	32	25	150	3			
SPRP 1003	S03 D35 d32 L150	35	32	150	3			
SPRP 1204	S02 D25 d25 L120	25	25	120	2	RP. 1204	VRT 09 M4x11	T15
SPRP 1204	S02 D30 d25 L120	30	25	120	2			
SPRP 1204	S03 D32 d25 L120	32	25	120	3			
SPRP 1204	S03 D35 d32 L120	35	32	120	3			
SPRP 1204	S02 D25 d25 L150	25	25	150	2			
SPRP 1204	S02 D30 d25 L150	30	25	150	2			
SPRP 1204	S03 D32 d25 L150	32	25	150	3			
SPRP 1204	S03 D35 d32 L150	35	32	150	3			

SPWN

ÜRÜN / PRODUCT



TEKNİK ÇİZİM / TECHNICAL DRAWING

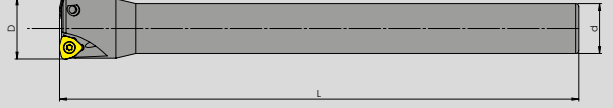

TAKIM KODU ORDERING CODE		TAKIM ÖLÇÜLERİ DIMENSIONS (mm)			KESİCİ UÇ ADET INSERT NUMBER	KESİCİ UÇ INSERT	YEDEK PARÇALAR / SPARE PARTS	
							BASKI VIDASI SCREW	ANAHTAR TORX KEY
		D	d	L				
SPWN06	S02 D16 d16 L150H	16	16	150	2	WNMX 06	VRT 04 M2,5x7	T08
SPWN06	S02 D20 d20 L150H	20	20	150	2			
SPWN09	S02 D25 d25 L150H	25	25	150	2	WNMX 09	VRT 05 M3x8	T10
SPWN09	S02 D26 d25 L150H	26	25	150	2			

BTKR

ÜRÜN / PRODUCT



TEKNİK ÇİZİM / TECHNICAL DRAWING

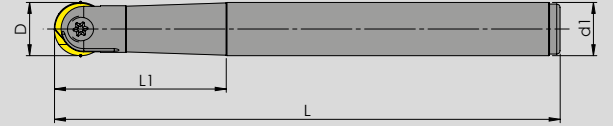

TAKIM KODU ORDERING CODE		TAKIM ÖLÇÜLERİ DIMENSIONS (mm)				KESİCİ UÇ INSERT	YEDEK PARÇALAR / SPARE PARTS	
							BASKI VIDASI SCREW	ANAHTAR TORX KEY
		D	d1	L	L1			
BTKR08	10-110	8	10	110	25	Q8 WLTR	VKV 01 M3	T08
BTKR10	12-130	10	12	130	30	Q10 WLTR	VKV 02 M4	T15
BTKR12	12-130	12	12	130	32	Q12 WLTR	VKV 03 M5	T20
BTKR16	16-175	16	16	175	60	Q16 WLTR	VKV 04 M5	T20
BTKR20	20-200	20	20	200	100	Q20 WLTR	VKV 05 M6	T20
BTKR25	25-200	25	25	200	100	Q25 WLTR	VKV 05 M6	T20
BTKR32	32-200	32	32	200	100	Q32 WLTR	VKV 06 M8	T30

SPLN 10-15

ÜRÜN / PRODUCT

90°



TEKNİK ÇİZİM / TECHNICAL DRAWING

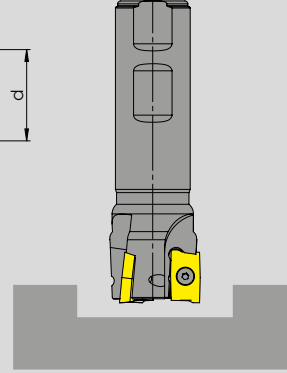
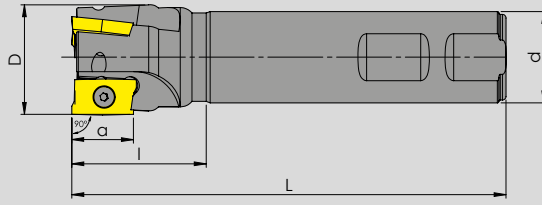

TAKIM KODU ORDERING CODE		TAKIM ÖLÇÜLERİ DIMENSIONS (mm)			KESİCİ UÇ ADET INSERT NUMBER	KESİCİ UÇ INSERT	YEDEK PARÇALAR / SPARE PARTS	
							BASKI VIDASI SCREW	ANAHTAR TORX KEY
SPLN10	S02 D18 d16 L150	D	d	L				
SPLN10	S02 D20 d20 L150	18	16	150	2	LNMT.. 1006	VRT 05 M3x8	T10
SPLN10	S02 D21 d20 L150	20	20	150	2			
SPLN10	S02 D21 d20 L150	21	20	150	2			
SPLN10	S03 D25 d25 L150	25	25	150	3			
SPLN10	S03 D26 d25 L150	26	25	150	3			
SPLN15	S02 D32 d32 L200	32	32	200	2	LNMT.. 1510	VRT 09 M4x11	T15
SPLN15	S02 D33 d32 L200	33	32	200	2			

SPLO 15

ÜRÜN / PRODUCT

90°



TEKNİK ÇİZİM / TECHNICAL DRAWING

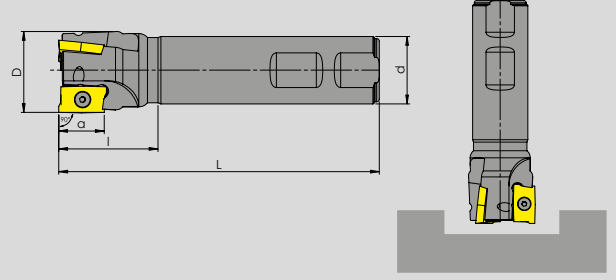

TAKIM KODU ORDERING CODE		TAKIM ÖLÇÜLERİ DIMENSIONS (mm)			KESİCİ UÇ ADET INSERT NUMBER	KESİCİ UÇ INSERT	YEDEK PARÇALAR / SPARE PARTS	
							BASKI VİDASI SCREW	ANAHTAR TORX KEY
		D	d	L				
SPLO 15	S02 D25 d25 L150	25	25	150	2	LO.. 15	VRT 06 M3,5x9	T15
SPLO 15	S03 D32 d25 L150	32	25	150	3			

SPXN 06

ÜRÜN / PRODUCT



TEKNİK ÇİZİM / TECHNICAL DRAWING

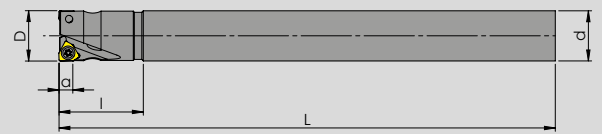

TAKIM KODU ORDERING CODE		TAKIM ÖLÇÜLERİ DIMENSIONS (mm)			KESİCİ UÇ ADET INSERT NUMBER	KESİCİ UÇ INSERT	YEDEK PARÇALAR / SPARE PARTS	
							BASKI VİDASI SCREW	ANAHTAR TORX KEY
		D	d	L				
SPXN 06H	S02 D21 d20 L200	21	20	200	2	XN.. 06	VRT 05 M3x8	T10
SPXN 06H	S03 D26 d25 L200	26	25	200	3			
SPXN 06H	S04 D33 d32 L200	33	32	200	4			

SPAP 11R390

ÜRÜN / PRODUCT

90°



TEKNİK ÇİZİM / TECHNICAL DRAWING

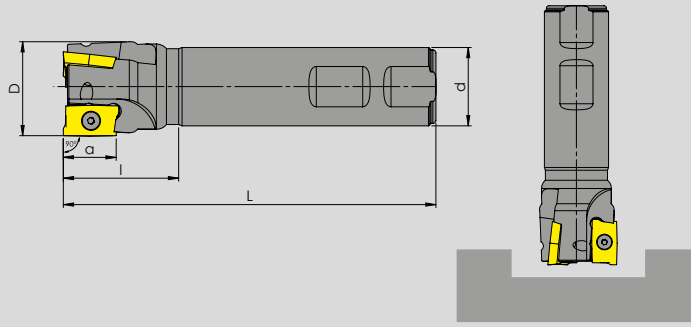

TAKIM KODU ORDERING CODE		TAKIM ÖLÇÜLERİ DIMENSIONS (mm)			KESİCİ UÇ ADET INSERT NUMBER	KESİCİ UÇ INSERT	YEDEK PARÇALAR / SPARE PARTS	
							BASKI VIDASI SCREW	ANAHTAR TORX KEY
		D	d	L				
SPAP11R390	S02 D16 d16 L100	16	16	100	2	AP. 11 R390	VRT 04 M2,5x7	T08
SPAP11R390	S02 D18 d16 L100	18	16	100	2			
SPAP11R390	S03 D20 d20 L100	20	20	100	3			
SPAP11R390	S03 D25 d25 L100	25	25	100	3			
SPAP11R390	S04 D30 d25 L100	30	25	100	4			
SPAP11R390	S02 D16 d16 L120	16	16	120	2			
SPAP11R390	S02 D18 d16 L120	18	16	120	2			
SPAP11R390	S03 D20 d20 L120	20	20	120	3			
SPAP11R390	S03 D25 d25 L120	25	25	120	3			
SPAP11R390	S04 D30 d25 L120	30	25	120	4			
SPAP11R390	S02 D16 d16 L150	16	16	150	2			
SPAP11R390	S02 D18 d16 L150	18	16	150	2			
SPAP11R390	S03 D20 d20 L150	20	20	150	3			
SPAP11R390	S03 D25 d25 L150	25	25	150	3			
SPAP11R390	S04 D30 d25 L150	30	25	150	4			
SPAP11R390	S02 D16 d16 L200	16	16	200	2			
SPAP11R390	S03 D20 d20 L200	20	20	200	3			
SPAP11R390	S03 D25 d25 L200	25	25	200	3			

SPAP 17R390

ÜRÜN / PRODUCT

90°



TEKNİK ÇİZİM / TECHNICAL DRAWING

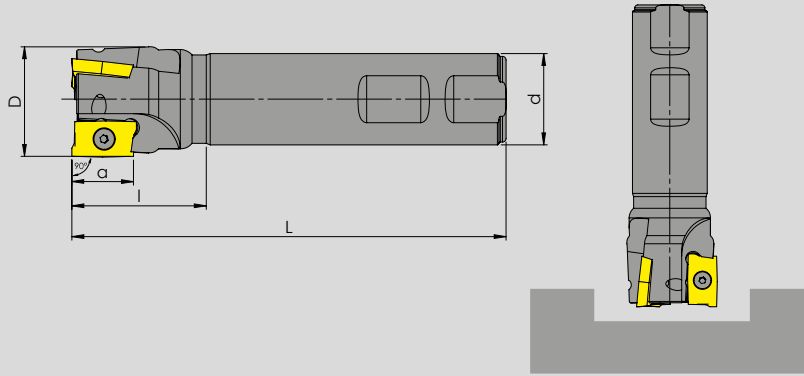

TAKIM KODU ORDERING CODE		TAKIM ÖLÇÜLERİ DIMENSIONS (mm)			KESİCİ UÇ ADET INSERT NUMBER	KESİCİ UÇ INSERT	YEDEK PARÇALAR / SPARE PARTS	
							BASKI VİDASI SCREW	ANAHTAR TORX KEY
		D	d	L				
SPAP17R390	S02 D25 d25 L100	25	25	100	2	AP. 17 R390	VRT 06 M3,5x9	T15
SPAP17R390	S03 D30 d25 L100	30	25	100	3			
SPAP17R390	S03 D32 d25 L100	32	25	100	3			
SPAP17R390	S02 D25 d25 L120	25	25	120	2			
SPAP17R390	S03 D30 d25 L120	30	25	120	3			
SPAP17R390	S03 D32 d25 L120	32	25	120	3			
SPAP17R390	S02 D25 d25 L150	25	25	150	2			
SPAP17R390	S03 D30 d25 L150	30	25	150	3			
SPAP17R390	S03 D32 d25 L150	32	25	150	3			

SPAP 1135

ÜRÜN / PRODUCT

90°



TEKNİK ÇİZİM / TECHNICAL DRAWING

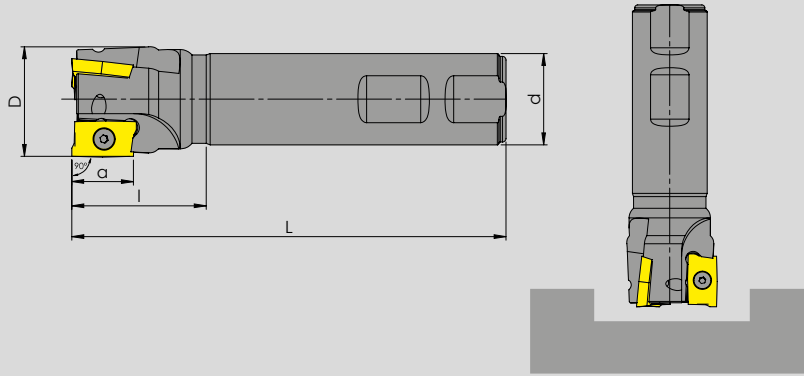

TAKIM KODU ORDERING CODE		TAKIM ÖLÇÜLERİ DIMENSIONS (mm)			KESİCİ UÇ ADET INSERT NUMBER	KESİCİ UÇ INSERT	YEDEK PARÇALAR / SPARE PARTS	
							BASKI VIDASI SCREW	ANAHTAR TORX KEY
		D	d	L				
SPAP1135	S02 D16 d16 L100	16	16	100	2	AP. 1135	VRT 04 M2,5x7	T08
SPAP1135	S03 D20 d20 L100	20	20	100	3			
SPAP1135	S03 D25 d25 L100	25	25	100	3			
SPAP1135	S02 D16 d16 L120	16	16	120	2			
SPAP1135	S03 D20 d20 L120	20	20	120	3			
SPAP1135	S03 D25 d25 L120	25	25	120	3			
SPAP1135	S02 D16 d16 L150	16	16	150	2			
SPAP1135	S03 D20 d20 L150	20	20	150	3			
SPAP1135	S03 D25 d25 L150	25	25	150	3			
SPAP1135	S02 D16 d16 L200	16	16	200	2			
SPAP1135	S03 D20 d20 L200	20	20	200	3			
SPAP1135	S03 D25 d25 L200	25	25	200	3			
SPAP1135	S02 D17 d16 L150	17	16	150	2			
SPAP1135	S03 D21 d20 L150	21	20	150	3			
SPAP1135	S03 D26 d25 L150	26	25	150	3			

SPAP 11 T3

ÜRÜN / PRODUCT

90°



TEKNİK ÇİZİM / TECHNICAL DRAWING

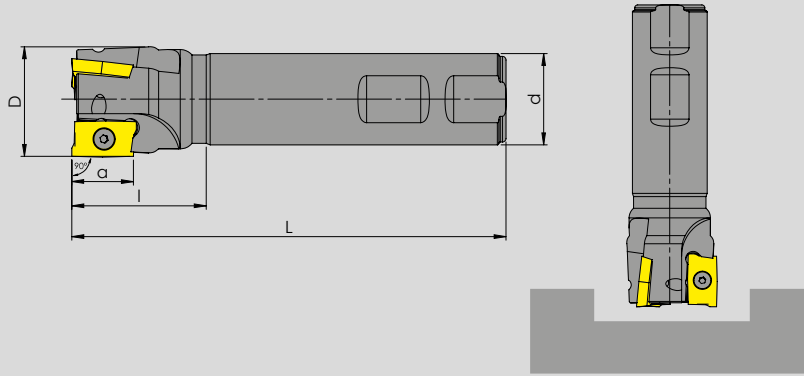

TAKIM KODU ORDERING CODE		TAKIM ÖLÇÜLERİ DIMENSIONS (mm)			KESİCİ UÇ ADET INSERT NUMBER	KESİCİ UÇ INSERT	YEDEK PARÇALAR / SPARE PARTS	
							BASKI VIDASI SCREW	ANAHTAR TORX KEY
		D	d	L				
SPAP11T3	S02 D16 d16 L100	16	16	100	2	AP. 11T3	VRT 04 M2,5x7	T08
SPAP11T3	S03 D20 d20 L100	20	20	100	3			
SPAP11T3	S03 D25 d25 L100	25	25	100	3			
SPAP11T3	S02 D16 d16 L120	16	16	120	2			
SPAP11T3	S03 D20 d20 L120	20	20	120	3			
SPAP11T3	S03 D25 d25 L120	25	25	120	3			
SPAP11T3	S02 D16 d16 L150	16	16	150	2			
SPAP11T3	S03 D20 d20 L150	20	20	150	3			
SPAP11T3	S03 D25 d25 L150	25	25	150	3			
SPAP11T3	S02 D16 d16 L200	16	16	200	2			
SPAP11T3	S03 D20 d20 L200	20	20	200	3			
SPAP11T3	S03 D25 d25 L200	25	25	200	3			

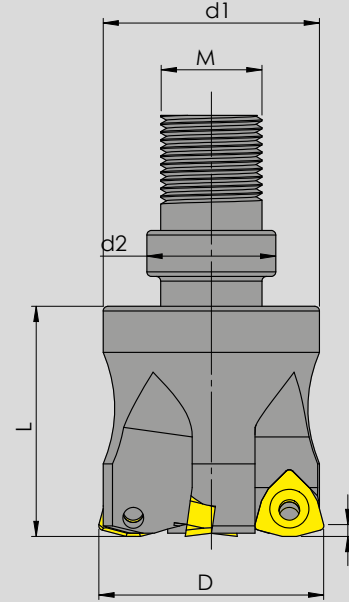

TAKIM KODU ORDERING CODE		TAKIM ÖLÇÜLERİ DIMENSIONS (mm)					KESİCİ UÇ ADET INSERT NUMBER	KESİCİ UÇ INSERT	YEDEK PARÇALAR / SPARE PARTS	
									BASKI VIDASI SCREW	ANAHTAR TORX KEY
HRMDM	0616 HR-M08 Z02	16	8,5	14,5	42	M08				
HRMDM	0617 HR-M08 Z02	17	8,5	14,5	42	M08	2	WNM.. 06	VRT 04 M2,5x7	T08
HRMDM	0620 HR-M10 Z02	20	10,5	18	51	M10	2			
HRMDM	0621 HR-M10 Z02	21	10,5	18	51	M10	2			
HRMDM	0625 HR-M12 Z03	25	12,5	23	59	M12	3			
HRMDM	0626 HR-M12 Z03	26	12,5	23	59	M12	3			
HRMDM	0925 HR-M12 Z02	25	12,5	23	59	M12	2			
HRMDM	0926 HR-M12 Z02	26	12,5	23	59	M12	2	WNM.. 09	VRT 05 M3x8	T10
HRMDM	0935 HR-M16 Z04	35	17	29	67	M16	4			
HRMDM	0940 HR-M16 Z04	40	17	29	67	M16	4			
HRMDM	0942 HR-M16 Z04	42	17	29	67	M16	4			

MFHLO

ÜRÜN / PRODUCT



TEKNİK ÇİZİM / TECHNICAL DRAWING

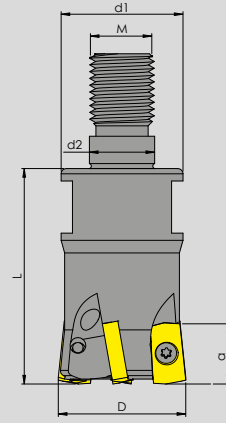

TAKIM KODU ORDERING CODE	TAKIM ÖLÇÜLERİ DIMENSIONS (mm)	KESİCİ UÇ ADET INSERT NUMBER	KESİCİ UÇ INSERT	YEDEK PARÇALAR / SPARE PARTS						
				BASKI VIDASI SCREW	ANAHTAR TORX KEY					
	D d2 d1 L M									
MFHLO	25 M12-104T Z02	25	12,5	23	59	M12	2	LO.. 10	VRT 05 M3x8	T10
MFHLO	32 M16-104T Z03	32	17	29	67	M16	3			
MFHLO	40 M16-104T Z04	40	17	29	67	M16	4			





MFHSO

ÜRÜN / PRODUCT

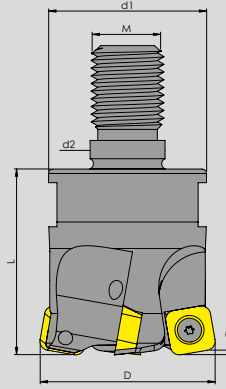

TEKNİK ÇİZİM / TECHNICAL DRAWING



TAKIM KODU ORDERING CODE	TAKIM ÖLÇÜLERİ DIMENSIONS (mm)	KESİCİ UÇ ADET INSERT NUMBER	KESİCİ UÇ INSERT	YEDEK PARÇALAR / SPARE PARTS						
				BASKI VIDASI SCREW	ANAHTAR TORX KEY					
	D d2 d1 L M									
MFHSO	32 M16-104T Z03	32	17	29	67	M16	3	SO.. 10	VRT 06 M3,5x9	T15
MFHSO	40 M16-104T Z04	40	17	29	67	M16	4			

VMF RD

ÜRÜN / PRODUCT



TEKNİK ÇİZİM / TECHNICAL DRAWING

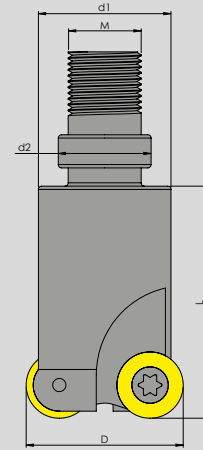

TAKIM KODU ORDERING CODE	TAKIM ÖLÇÜLERİ DIMENSIONS (mm)	KESİCİ UÇ ADET INSERT NUMBER	KESİCİ UÇ INSERT	YEDEK PARÇALAR / SPARE PARTS	
				BASKI VİDASI SCREW	ANAHTAR TORX KEY
VMF RD10	25 H M12 Z03	3	RD.. 1003	VRT 06 M3,5x9	T15
VMF RD10	30 H M16 Z04	4			
VMF RD10	35 H M16 Z04	4			

SD09

ÜRÜN / PRODUCT



TEKNİK ÇİZİM / TECHNICAL DRAWING

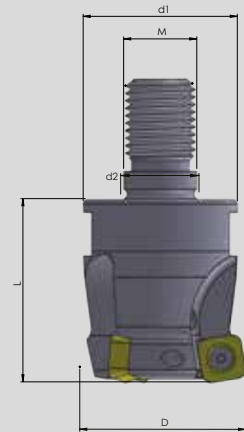

TAKIM KODU ORDERING CODE	TAKIM ÖLÇÜLERİ DIMENSIONS (mm)	KESİCİ UÇ ADET INSERT NUMBER	KESİCİ UÇ INSERT	YEDEK PARÇALAR / SPARE PARTS	
				BASKI VİDASI SCREW	ANAHTAR TORX KEY
VMF SD09	25 H M12 Z02	2	SD.. 09T3	VRT 06 M3,5x9	T15
VMF SD09	32 H M16 Z02	2			
VMF SD09	40 H M16 Z04	4			

 **VORGEN®**



DELİK DELME VE
TORNALAMA
Hole drilland lathe
www.vorgen.com

The red power for
the professionals
Profesyoneller için
Kırmızı Güç

BTMT

ÜRÜN / PRODUCT



TEKNİK ÇİZİM / TECHNICAL DRAWING

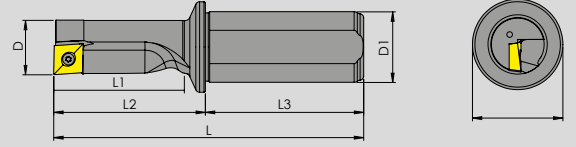

TAKIM KODU ORDERING CODE		TAKIM ÖLÇÜLERİ DIMENSIONS (mm)							KESİCİ UÇ INSERT	YEDEK PARÇALAR / SPARE PARTS	
										BASKI VİDASI SCREW	ANAHTAR TORX KEY
		L	L1	L2	L3	D	D1	D2			
BTMT	10Rx2,25D	72	22,5	30	42	10	12	16	XC.. 030204	VRT 01 M2x5	T06
BTMT	12Rx2,25D	78	27	33	45	12	16	20	XC.. 060304	VRT 02 M2,2x5	T06
BTMT	14Rx2,25D	83	31,5	38	45	14	16	20	XC.. 070304	VRT 03 M2,5x5	T08
BTMT	16Rx2,25D	94	36	44	50	16	20	25	XC.. 080304	VRT 05 M3x6	T10
BTMT	20Rx2,25D	111	45	55	56	20	25	32	XC.. 10T304	VRT 06 M3,5x9	T15
BTMT	25Rx2,25D	129	56,5	69	60	25	32	40	XC.. 130404	VRT10 M4,5x10	T20

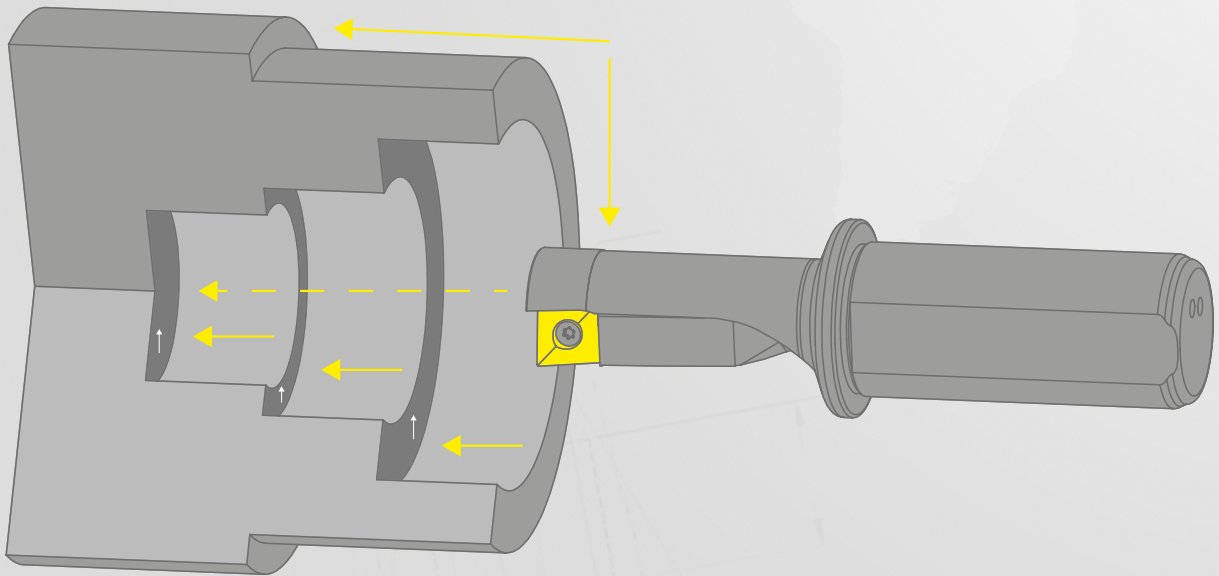

SCGCR

ÜRÜN / PRODUCT

90°



TEKNİK ÇİZİM / TECHNICAL DRAWING

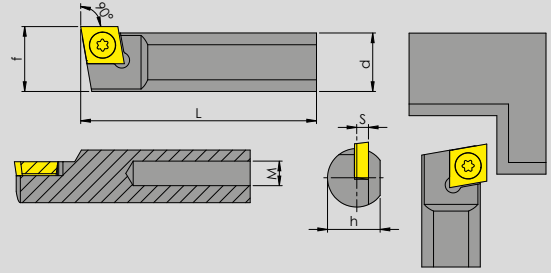

TAKIM KODU ORDERING CODE		TAKIM ÖLÇÜLERİ DIMENSIONS (mm)							KESİCİ UÇ INSERT	YEDEK PARÇALAR / SPARE PARTS	
										BASKI VİDASI SCREW	ANAHTAR TORX KEY
		d	h	L	S	f	M				
S10A	SCGCR/L 06	10	9	32	1	10	M5	CC.. 0602	VRT 04 M2,5x7	T08	
S10B	SCGCR/L 06	10	9	40	1	10	M5				
S10C	SCGCR/L 06	10	9	50	1	10	M5				
S12A	SCGCR/L 06	12	11	32	1	12	M5				
S12B	SCGCR/L 06	12	11	40	1	12	M5				
S12C	SCGCR/L 06	12	11	50	1	12	M5				
S16A	SCGCR/L 09	16	16	32	2	16	M6x1	CC.. 09T3	VRT 06 M3,5x9	T15	
S16B	SCGCR/L 09	16	16	40	2	16	M6x1				
S16C	SCGCR/L 09	16	16	50	2	16	M6x1				





BTDR 2D



ÜRÜN / PRODUCT

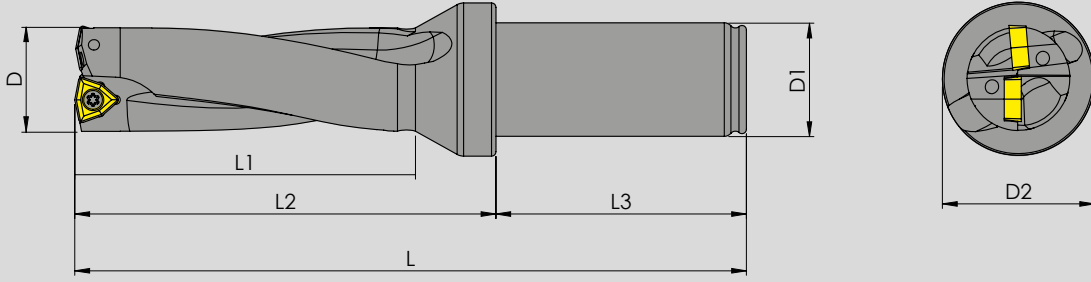

TEKNİK ÇİZİM / TECHNICAL DRAWING



TAKIM KODU ORDERING CODE		TAKIM ÖLÇÜLERİ DIMENSIONS (mm)							KESİCİ UÇ INSERT	YEDEK PARÇALAR / SPARE PARTS	
										BASKI VİDASI SCREW	ANAHTAR TORX KEY
		L	L1	L2	L3	D	D1	D2			
BTDR	2Dx16	108	32	52	56	16	25	34	WCM.. 030208	VRT 03 M2,5x5	T08
BTDR	2Dx16,5	108	33	52	56	16,5	25	34			
BTDR	2Dx17	110	34	54	56	17	25	34			
BTDR	2Dx17,5	110	35	54	56	17,5	25	34			
BTDR	20x18	113	36	57	56	18	25	34			
BTDR	2Dx18,5	113	37	57	56	18,5	25	34			
BTDR	2Dx19	115	38	59	56	19	25	34			
BTDR	2Dx19,5	115	39	59	56	19,5	25	34			
BTDR	2Dx20	119	40	63	56	20	25	34			
BTDR	2Dx20,5	119	41	63	56	20,5	25	34	WCM.. 040208	VRT 04 M2,5x5	T08
BTDR	2Dx21	121	42	65	56	21	25	34			
BTDR	2Dx21,5	121	43	65	56	21,5	25	34			
BTDR	2Dx22	123	44	67	56	22	25	34			
BTDR	2Dx22,5	123	45	67	56	22,5	25	34			
BTDR	2Dx23	127	46	71	56	23	25	34			
BTDR	2Dx23,5	127	47	71	56	23,5	25	34			

TAKIM KODU ORDERING CODE		TAKIM ÖLÇÜLERİ DIMENSIONS (mm)							KESİCİ UÇ INSERT	YEDEK PARÇALAR / SPARE PARTS				
										BASKI VİDASI SCREW	ANAHTAR TORX KEY			
		L	L1	L2	L3	D	D1	D2						
BTDR	2Dx24	130	48	74	56	24	25	44	WCM.. 050308	VRT 05 M3x8	T10			
BTDR	2Dx24,5	130	49	74	56	24,5	25	44						
BTDR	2Dx25	133	50	77	56	25	25	44						
BTDR	2Dx25,5	133	51	77	56	25,5	25	44						
BTDR	2Dx26	135	52	79	56	26	25	44						
BTDR	2Dx26,5	135	53	79	56	26,5	25	44						
BTDR	2Dx27	137	54	81	56	27	25	44						
BTDR	2Dx27,5	137	55	81	56	27,5	25	44						
BTDR	2Dx28	140	56	84	56	28	25	44						
BTDR	2Dx28,5	140	57	84	56	28,5	25	44						
BTDR	2Dx29	142	58	86	56	29	25	44						
BTDR	2Dx29,5	142	59	86	56	29,5	25	44						
BTDR	2Dx30	151	60	91	56	30	32	44				WCM.. 06T308	VRT 06 M3,5x9	T15
BTDR	2Dx31	154	61	94	60	31	32	44						
BTDR	2Dx32	156	62	96	60	32	32	44						
BTDR	2Dx33	159	63	99	60	33	32	44						
BTDR	2Dx34	161	64	101	60	34	32	44						
BTDR	2Dx35	164	70	97	60	35	32	44						
BTDR	2Dx36	166	75	99	60	36	32	44						
BTDR	2Dx37	168	74	101	60	37	32	44						
BTDR	2Dx38	170	76	103	60	38	32	44						
BTDR	2Dx39	172	78	105	60	39	32	44						
BTDR	2Dx40	174	80	107	60	40	32	44						
BTDR	2Dx41	176	82	109	60	41	32	44						
BTDR	2Dx42	178	84	111	60	42	32	44						
BTDR	2Dx43	180	86	113	60	43	32	44						
BTDR	2Dx44	182	88	115	60	44	32	44						
BTDR	2Dx45	184	90	122	70	45	40	54	WCM.. 080412	VRT 09 M4x11	T15			
BTDR	2Dx46	186	92	124	70	46	40	54						
BTDR	2Dx47	188	94	126	70	47	40	54						
BTDR	2Dx48	190	96	128	70	48	40	54						
BTDR	2Dx49	192	98	130	70	49	40	54						
BTDR	2Dx50	194	100	132	70	50	40	54						
BTDR	2Dx51	196	102	134	70	51	40	54						
BTDR	2Dx52	198	104	136	70	52	40	54						
BTDR	2Dx53	200	106	138	70	53	40	54						
BTDR	2Dx54	202	108	140	70	54	40	54						
BTDR	2Dx55	204	110	142	70	55	40	54						
BTDR	2Dx56	206	112	144	70	56	40	54						
BTDR	2Dx57	208	114	146	70	57	40	54						
BTDR	2Dx58	210	116	148	70	58	40	54						
BTDR	2Dx59	212	118	150	70	59	40	54						
BTDR	2Dx60	214	120	152	70	60	40	54						

BTDR 3D



ÜRÜN / PRODUCT

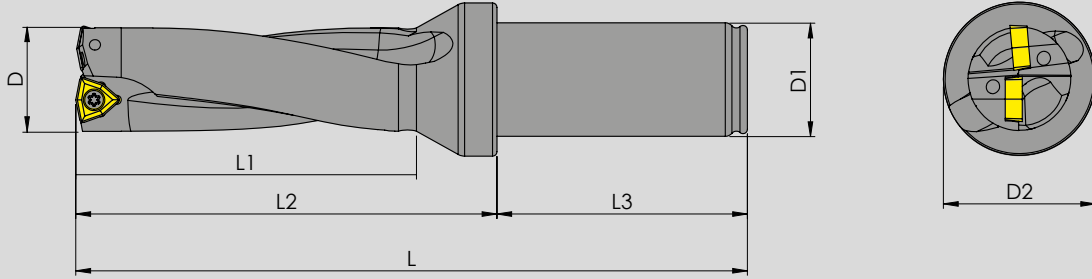

TEKNİK ÇİZİM / TECHNICAL DRAWING



TAKIM KODU ORDERING CODE		TAKIM ÖLÇÜLERİ DIMENSIONS (mm)							KESİCİ UÇ INSERT	YEDEK PARÇALAR / SPARE PARTS	
										BASKI VİDASI SCREW	ANAHTAR TORX KEY
		L	L1	L2	L3	D	D1	D2			
BTDR	3Dx16	124	48	68	56	16	25	34	WCM.. 030208	VRT 03 M2,5x5	T08
BTDR	3Dx16,5	124	48	68	56	16,5	25	34			
BTDR	3Dx17	127	51	71	56	17	25	34			
BTDR	3Dx17,5	127	51	71	56	17,5	25	34			
BTDR	3Dx18	131	54	75	56	18	25	34			
BTDR	3Dx18,5	131	54	75	56	18,5	25	34			
BTDR	3Dx19	134	57	78	56	19	25	34			
BTDR	3Dx19,5	134	57	78	56	19,5	25	34			
BTDR	3Dx20	139	60	83	56	20	25	34			
BTDR	3Dx20,5	139	60	83	56	20,5	25	34	WCM.. 040208	VRT 04 M2,5x5	T08
BTDR	3Dx21	142	63	86	56	21	25	34			
BTDR	3Dx21,5	142	63	86	56	21,5	25	34			
BTDR	3Dx22	145	66	89	56	22	25	34			
BTDR	3Dx22,5	145	66	89	56	22,5	25	34			
BTDR	3Dx23	150	69	94	56	23	25	34			
BTDR	3Dx23,5	150	69	94	56	23,5	25	34			

TAKIM KODU ORDERING CODE		TAKIM ÖLÇÜLERİ DIMENSIONS (mm)							KESİCİ UÇ INSERT	YEDEK PARÇALAR / SPARE PARTS				
										BASKI VİDASI SCREW	ANAHTAR TORX KEY			
		L	L1	L2	L3	D	D1	D2						
BTDR	3Dx24	154	72	98	56	24	25	44	WCM.. 050308	VRT 05 M3x8	T10			
BTDR	3Dx24,5	154	72	98	56	24,5	25	44						
BTDR	3Dx25	158	75	102	56	25	25	44						
BTDR	3Dx25,5	158	75	102	56	25,5	25	44						
BTDR	3Dx26	161	78	105	56	26	25	44						
BTDR	3Dx26,5	161	78	105	56	26,5	25	44						
BTDR	3Dx27	164	81	108	56	27	25	44						
BTDR	3Dx27,5	164	81	108	56	27,5	25	44						
BTDR	3Dx28	168	84	112	56	28	25	44						
BTDR	3Dx28,5	168	84	112	56	28,5	25	44						
BTDR	3Dx29	171	87	115	56	29	25	44						
BTDR	3Dx29,5	171	87	115	56	29,5	25	44						
BTDR	3Dx30	180	90	121	56	30	32	44				WCM.. 06T308	VRT 06 M3,5x9	T15
BTDR	3Dx31	181	93	125	60	31	32	44						
BTDR	3Dx32	188	96	128	60	32	32	44						
BTDR	3Dx33	192	99	132	60	33	32	44						
BTDR	3Dx34	195	102	135	60	34	32	44						
BTDR	3Dx35	192	105	132	60	35	32	44						
BTDR	3Dx36	195	108	135	60	36	32	44						
BTDR	3Dx37	198	111	138	60	37	32	44						
BTDR	3Dx38	201	114	141	60	38	32	44						
BTDR	3Dx39	204	117	144	60	39	32	44						
BTDR	3Dx40	207	120	147	60	40	32	44						
BTDR	3Dx41	210	123	150	60	41	32	44						
BTDR	3Dx42	213	126	153	60	42	32	44						
BTDR	3Dx43	216	129	156	60	43	32	44	WCM.. 080412	VRT 09 M4x11	T15			
BTDR	3Dx44	219	132	159	60	44	32	44						
BTDR	3Dx45	237	135	167	70	45	40	54						
BTDR	3Dx46	240	138	170	70	46	40	54						
BTDR	3Dx47	243	141	173	70	47	40	54						
BTDR	3Dx48	246	144	176	70	48	40	54						
BTDR	3Dx49	249	147	179	70	49	40	54						
BTDR	3Dx50	252	150	182	70	50	40	54						
BTDR	3Dx51	255	153	185	70	51	40	54						
BTDR	3Dx52	258	156	188	70	52	40	54						
BTDR	3Dx53	261	159	191	70	53	40	54						
BTDR	3Dx54	264	162	194	70	54	40	54						
BTDR	3Dx55	267	165	197	70	55	40	54						
BTDR	3Dx56	270	168	200	70	56	40	54						
BTDR	3Dx57	273	171	203	70	57	40	54						
BTDR	3Dx58	276	174	206	70	58	40	54						
BTDR	3Dx59	279	177	209	70	59	40	54						
BTDR	3Dx60	282	180	212	70	60	40	54						



BTDR 4D

ÜRÜN / PRODUCT

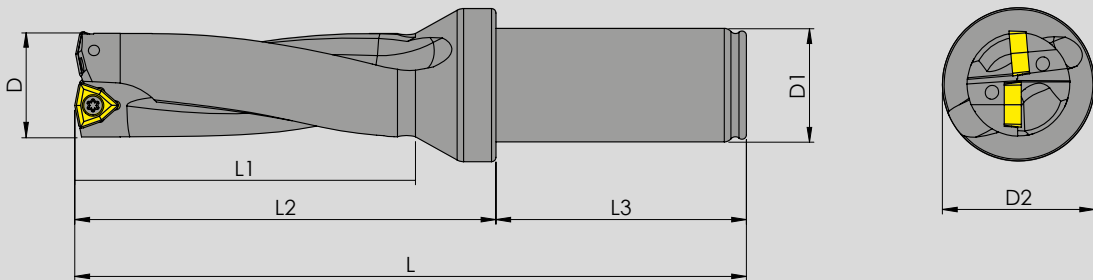

TEKNİK ÇİZİM / TECHNICAL DRAWING





TAKIM KODU ORDERING CODE		TAKIM ÖLÇÜLERİ DIMENSIONS (mm)							KESİCİ UÇ INSERT	YEDEK PARÇALAR / SPARE PARTS	
										BASKI VİDASI SCREW	ANAHTAR TORX KEY
		L	L1	L2	L3	D	D1	D2			
BTDR	4Dx16	142	64	86	56	16	25	34	WCM.. 030208	VRT 03 M2,5x5	T08
BTDR	4Dx16,5	142	64	86	56	16,5	25	34			
BTDR	4Dx17	146	68	90	56	17	25	34			
BTDR	4Dx17,5	146	68	90	56	17,5	25	34			
BTDR	4Dx18	150	72	94	56	18	25	34			
BTDR	4Dx18,5	150	72	94	56	18,5	25	34			
BTDR	4Dx19	154	76	98	56	19	25	34			
BTDR	4Dx19,5	154	76	98	56	19,5	25	34			
BTDR	4Dx20	158	80	102	56	20	25	34			
BTDR	4Dx20,5	158	80	102	56	20,5	25	34	WCM.. 040208	VRT 04 M2,5x5	T08
BTDR	4Dx21	162	84	106	56	21	25	34			
BTDR	4Dx21,5	162	84	106	56	21,5	25	34			
BTDR	4Dx22	166	88	110	56	22	25	34			
BTDR	4Dx22,5	166	88	110	56	22,5	25	34			
BTDR	4Dx23	170	92	114	56	23	25	34			
BTDR	4Dx23,5	170	92	114	56	23,5	25	34			
BTDR	4Dx24	174	96	118	56	24	25	44			
BTDR	4Dx24,5	174	96	118	56	24,5	25	44			
BTDR	4Dx25	178	100	122	56	25	25	44	WCM.. 050308	VRT 05 M3x8	T10
BTDR	4Dx25,5	178	100	122	56	25,5	25	44			
BTDR	4Dx26	182	104	126	56	26	25	44			
BTDR	4Dx26,5	182	104	126	56	26,5	25	44			
BTDR	4Dx27	186	108	130	56	27	25	44			
BTDR	4Dx27,5	186	108	130	56	27,5	25	44			
BTDR	4Dx28	190	112	134	56	28	25	44			
BTDR	4Dx28,5	190	112	134	56	28,5	25	44			
BTDR	4Dx29	194	116	138	56	29	25	44			
BTDR	4Dx29,5	194	116	138	56	29,5	25	44	WCM.. 06T308	VRT 06 M3,5x9	T15
BTDR	4Dx30	207	120	147	60	30	32	44			
BTDR	4Dx31	211	124	151	60	31	32	44			
BTDR	4Dx32	215	128	155	60	32	32	44			
BTDR	4Dx33	219	132	159	60	33	32	44			
BTDR	4Dx34	223	136	163	60	34	32	44			
BTDR	4Dx35	227	140	167	60	35	32	44			
BTDR	4Dx36	231	144	171	60	36	32	44			
BTDR	4Dx37	235	148	175	60	37	32	44			
BTDR	4Dx38	239	152	179	60	38	32	44			
BTDR	4Dx39	243	156	183	60	39	32	44			
BTDR	4Dx40	247	160	187	60	40	32	44			
BTDR	4Dx41	251	164	191	60	41	32	44			
BTDR	4Dx42	255	168	195	60	42	32	44			
BTDR	4Dx43	259	172	199	60	43	32	44			
BTDR	4Dx44	263	176	203	60	44	32	44			

BTDR 5D

ÜRÜN / PRODUCT



TAKIM KODU ORDERING CODE		TAKIM ÖLÇÜLERİ DIMENSIONS (mm)							KESİCİ UÇ INSERT	YEDEK PARÇALAR / SPARE PARTS	
										BASKI VİDASI SCREW	ANAHTAR TORX KEY
		L	L1	L2	L3	D	D1	D2			
BTDR	5Dx16	156	80	68	56	16	25	34	WCM.. 030208	VRT 03 M2,5x5	T08
BTDR	5Dx17	161	85	71	56	17	25	34			
BTDR	5Dx18	167	90	75	56	18	25	34			
BTDR	5Dx19	172	95	78	56	19	25	34			
BTDR	5Dx20	179	100	83	56	20	25	34	WCM.. 040208	VRT 04 M2,5x5	T08
BTDR	5Dx21	184	105	86	56	21	25	34			
BTDR	5Dx22	189	110	89	56	22	25	34			
BTDR	5Dx23	193	115	94	56	23	25	24			
BTDR	5Dx24	198	120	98	56	24	25	44	WCM.. 050308	VRT 05 M3x8	T10
BTDR	5Dx25	203	125	102	56	25	25	44			
BTDR	5Dx26	207	130	105	56	26	25	44			
BTDR	5Dx27	211	135	108	56	27	25	44			
BTDR	5Dx28	216	140	112	56	28	25	44			
BTDR	5Dx29	220	145	115	56	29	25	44			
BTDR	5Dx30	224	150	121	60	30	32	44	WCM.. 06T308	VRT 06 M3,5x9	T15
BTDR	5Dx31	245	155	125	60	31	32	44			
BTDR	5Dx32	250	160	128	60	32	32	44			
BTDR	5Dx33	255	165	132	60	33	32	44			
BTDR	5Dx34	260	170	135	60	34	32	44			



TEKNİK ÇİZİM / TECHNICAL DRAWING

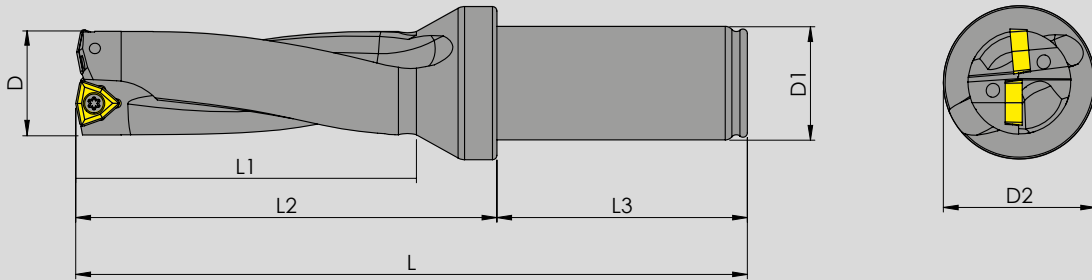





BTDR 2D

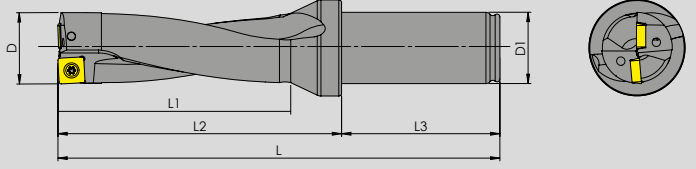

ÜRÜN / PRODUCT



TEKNİK ÇİZİM / TECHNICAL DRAWING







TAKIM KODU ORDERING CODE		TAKIM ÖLÇÜLERİ DIMENSIONS (mm)							KESİCİ UÇ INSERT	YEDEK PARÇALAR / SPARE PARTS	
										BASKI VİDASI SCREW	ANAHTAR TORX KEY
		L	L1	L2	L3	D	D1	D2			
BTDR	2Dx13	98	26	48	50	13	20	25	SP. 050204	VRT 01 M2x5	T06
BTDR	2Dx13,5	98	26	48	50	13,5	20	25			
BTDR	2Dx14	100	28	50	50	14	20	25			
BTDR	2Dx14,5	100	28	50	50	14,5	20	25			
BTDR	2Dx15	102	30	52	50	15	20	25			
BTDR	2Dx15,5	102	30	52	50	15,5	20	25			
BTDR	2Dx16	110	32	54	56	16	25	34	SP. 060204	VRT 02 M2,2x5	T06
BTDR	2Dx16,5	110	32	54	56	16,5	25	34			
BTDR	2Dx17	111	34	56	56	17	25	34			
BTDR	2Dx17,5	111	34	56	56	17,5	25	34			
BTDR	2Dx18	114	36	58	56	18	25	34			
BTDR	2Dx18,5	114	36	58	56	18,5	25	34			
BTDR	2Dx19	116	38	60	56	19	25	34			
BTDR	2Dx19,5	116	38	60	56	19,5	25	34			
BTDR	2Dx20	118	40	62	56	20	25	34			
BTDR	2Dx20,5	118	40	62	56	20,5	25	34			
BTDR	2Dx21	120	42	64	56	21	25	34			
BTDR	2Dx21,5	120	42	64	56	21,5	25	34			

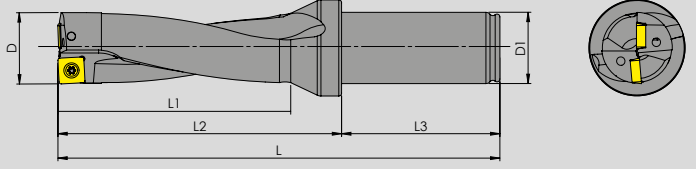

TAKIM KODU ORDERING CODE		TAKIM ÖLÇÜLERİ DIMENSIONS (mm)							KESİCİ UÇ INSERT	YEDEK PARÇALAR / SPARE PARTS	
										BASKI VİDASI SCREW	ANAHTAR TORX KEY
		L	L1	L2	L3	D	D1	D2			
BTDR	2Dx22	122	44	66	56	22	25	34	SP. 07T0308	VRT 03 M2,5x5	T08
BTDR	2Dx22,5	122	44	66	56	22,5	25	34			
BTDR	2Dx23	124	46	68	56	23	25	34			
BTDR	2Dx23,5	124	46	68	56	23,5	25	34			
BTDR	2Dx24	126	48	70	56	24	25	34			
BTDR	2Dx24,5	126	48	70	56	24,5	25	34			
BTDR	2Dx25	128	50	72	56	25	25	34			
BTDR	2Dx25,5	128	50	72	56	25,5	25	34			
BTDR	2Dx26	130	52	74	56	26	25	34			
BTDR	2Dx26,5	130	52	74	56	26,5	25	34			
BTDR	2Dx27	132	54	76	56	27	25	34			
BTDR	2Dx27,5	132	54	76	56	27,5	25	34			
BTDR	2Dx28	134	56	78	56	28	25	34			
BTDR	2Dx28,5	134	56	78	56	28,5	25	34			
BTDR	2Dx29	136	58	80	56	29	25	34	SP. 090408	VRT 06 M3,5x9	T15
BTDR	2Dx29,5	136	58	80	56	29,5	25	34			
BTDR	2Dx30	147	60	87	60	30	32	44			
BTDR	2Dx31	149	62	89	60	31	32	44			
BTDR	2Dx32	151	64	91	60	32	32	44			
BTDR	2Dx33	153	66	93	60	33	32	44			
BTDR	2Dx34	155	68	95	60	34	32	44			
BTDR	2Dx35	157	70	97	60	35	32	44	SP. 110408	VRT 09 M4x11	T15
BTDR	2Dx36	159	72	99	60	36	32	44			
BTDR	2Dx37	161	74	101	60	37	32	44			
BTDR	2Dx38	153	76	103	60	38	32	44			
BTDR	2Dx39	165	78	105	60	39	32	44			
BTDR	2Dx40	167	80	107	60	40	32	44			
BTDR	2Dx41	169	82	109	60	41	32	44			

BTDR 3D

ÜRÜN / PRODUCT



TAKIM KODU ORDERING CODE		TAKIM ÖLÇÜLERİ DIMENSIONS (mm)							KESİCİ UÇ INSERT	YEDEK PARÇALAR / SPARE PARTS	
										BASKI VİDASI SCREW	ANAHTAR TORX KEY
		L	L1	L2	L3	D	D1	D2			
BTDR	3Dx13	111	39	61	50	13	20	25	SP. 050204	VRT 01 M2x5	T06
BTDR	3Dx13,5	111	39	61	50	13,5	20	25			
BTDR	3Dx14	114	42	64	50	14	20	25			
BTDR	3Dx14,5	114	42	64	50	14,5	20	25			
BTDR	3Dx15	117	45	67	50	15	20	25			
BTDR	3Dx15,5	117	45	67	50	15,5	20	25			
BTDR	3Dx16	126	48	70	56	16	25	3			
BTDR	3Dx16,5	126	48	70	56	16,5	25	3			
BTDR	3Dx17	129	51	73	56	17	25	34			
BTDR	3Dx17,5	129	51	73	56	17,5	25	34			
BTDR	3Dx18	132	54	76	56	18	25	34	SP. 060204	VRT 02 M2,2x5	T06
BTDR	3Dx18,5	132	54	76	56	18,5	25	34			
BTDR	3Dx19	135	57	79	56	19	25	34			
BTDR	3Dx19,5	135	57	79	56	19,5	25	34			
BTDR	3Dx20	135	60	82	56	20	25	34			
BTDR	3Dx20,5	135	60	82	56	20,5	25	34			
BTDR	3Dx21	141	63	85	56	21	25	34			
BTDR	3Dx21,5	141	63	85	56	21,5	25	34			

TAKIM KODU ORDERING CODE		TAKIM ÖLÇÜLERİ DIMENSIONS (mm)							KESİCİ UÇ INSERT	YEDEK PARÇALAR / SPARE PARTS	
										BASKI VİDASI SCREW	ANAHTAR TORX KEY
		L	L1	L2	L3	D	D1	D2			
BTDR	3Dx22	144	66	88	56	22	25	34	SP. 07T0308	VRT 03 M2,5x5	T08
BTDR	3Dx22,5	144	66	88	56	22,5	25	34			
BTDR	3Dx23	147	69	91	56	23	25	34			
BTDR	3Dx23,5	147	69	91	56	23,5	25	34			
BTDR	3Dx24	150	72	94	56	24	25	34			
BTDR	3Dx24,5	150	72	94	56	24,5	25	34			
BTDR	3Dx25	153	75	97	56	25	25	34			
BTDR	3Dx25,5	153	75	97	56	25,5	25	34			
BTDR	3Dx26	156	78	100	56	26	25	34			
BTDR	3Dx26,5	156	78	100	56	26,5	25	34			
BTDR	3Dx27	159	81	103	56	27	25	34			
BTDR	3Dx27,5	159	81	103	56	27,5	25	34			
BTDR	3Dx28	162	84	106	56	28	25	34			
BTDR	3Dx28,5	162	84	106	56	28,5	25	34			
BTDR	3Dx29	165	87	109	56	29	25	34			
BTDR	3Dx29,5	165	87	109	56	29,5	25	34			
BTDR	3Dx30	177	90	117	60	30	32	44			
BTDR	3Dx31	180	93	120	60	31	32	44			
BTDR	3Dx32	183	96	123	60	32	32	44			
BTDR	3Dx33	186	99	126	60	33	32	44	SP. 110408	VRT 09 M4x11	T15
BTDR	3Dx34	189	102	129	60	34	32	44			
BTDR	3Dx35	192	105	132	60	35	32	44			
BTDR	3Dx36	195	108	135	60	36	32	44			
BTDR	3Dx37	198	111	138	60	37	32	44			
BTDR	3Dx38	201	114	141	60	38	32	44			
BTDR	3Dx39	204	117	144	60	39	32	44			
BTDR	3Dx40	207	120	147	60	40	32	44			
BTDR	3Dx41	210	123	150	60	41	32	44			



BTDR 4D

ÜRÜN / PRODUCT

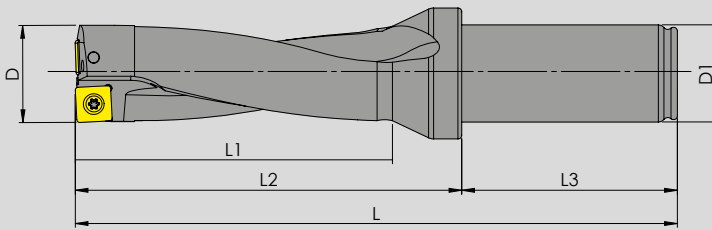

TEKNİK ÇİZİM / TECHNICAL DRAWING



TAKIM KODU ORDERING CODE		TAKIM ÖLÇÜLERİ DIMENSIONS (mm)							KESİCİ UÇ INSERT	YEDEK PARÇALAR / SPARE PARTS	
										BASKI VİDASI SCREW	ANAHTAR TORX KEY
		L	L1	L2	L3	D	D1	D2			
BTDR	4Dx13	124	52	74	50	13	20	25	SP. 050204	VRT 01 M2x5	T06
BTDR	4Dx14	128	56	78	50	14	20	25			
BTDR	4Dx15	132	60	82	50	15	20	25			
BTDR	4Dx16	142	64	86	56	16	25	34	SP. 060204	VRT 02 M2,2x5	T06
BTDR	4Dx17	146	68	90	56	17	25	34			
BTDR	4Dx18	150	72	94	56	18	25	34			
BTDR	4Dx19	154	76	98	56	19	25	34			
BTDR	4Dx20	158	80	102	56	20	25	34			
BTDR	4Dx21	162	84	106	56	21	25	34			
BTDR	4Dx22	166	88	110	56	22	25	34			
BTDR	4Dx23	170	92	114	56	23	25	34	SP. 07T0308	VRT 03 M2,5x5	T08
BTDR	4Dx24	174	96	118	56	24	25	34			
BTDR	4Dx25	178	100	122	56	25	25	34			
BTDR	4Dx26	182	104	126	56	26	25	34			
BTDR	4Dx27	186	108	130	56	27	25	34			
BTDR	4Dx28	190	112	134	56	28	25	34			
BTDR	4Dx29	194	116	138	56	29	25	34	SP. 090408	VRT 06 M3,5x9	T15
BTDR	4Dx30	207	120	147	60	30	32	44			
BTDR	4Dx31	211	124	151	60	31	32	44			
BTDR	4Dx32	215	128	155	60	32	32	44			
BTDR	4Dx33	219	132	159	60	33	32	44			
BTDR	4Dx34	223	136	163	60	34	32	44			
BTDR	4Dx35	227	140	167	60	35	32	44			
BTDR	4Dx36	231	144	171	60	36	32	44	SP. 110408	VRT 09 M4x11	T15
BTDR	4Dx37	235	148	175	60	37	32	44			
BTDR	4Dx38	239	152	179	60	38	32	44			
BTDR	4Dx39	243	156	183	60	39	32	44			
BTDR	4Dx40	247	160	187	60	40	32	44			
BTDR	4Dx41	251	164	191	60	41	32	44			





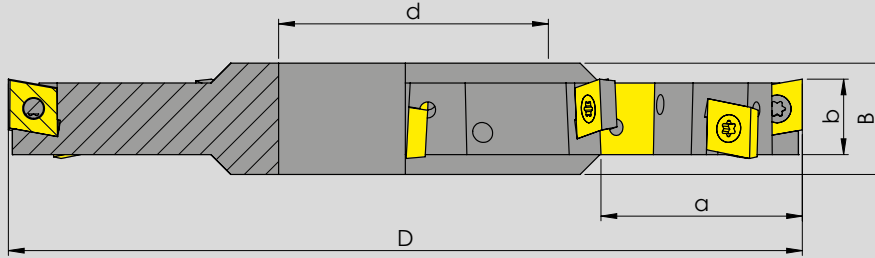

VRDF

ÜRÜN / PRODUCT



TEKNİK ÇİZİM / TECHNICAL DRAWING



TAKIM KODU ORDERING CODE			TAKIM ÖLÇÜLERİ DIMENSIONS (mm)							KESİCİ UÇ INSERT	YEDEK PARÇALAR / SPARE PARTS	
											BASKI VIDASI SCREW	ANAHTAR TORX KEY
VRDF	D80x8	d27-Z10	10	5	80	8	17	27	12	 CC.. 0602	 VRT 04 M2,5x7	 T08
VRDF	D100x8	d32-Z12	12	6	100	8	25	32	12			
VRDF	D125x8	d40-Z14	14	7	125	8	35	40	12			
VRDF	D80x10	d27-Z10	10	5	80	10	17	27	14			
VRDF	D100x10	d32-Z12	12	6	100	10	25	32	14			
VRDF	D125x10	d40-Z14	14	7	125	10	35	40	14			
VRDF	D80x12	d27-Z08	8	4	80	12	17	27	16	 CC.. 09T3	 VRT 06 M3,5x9	 T15
VRDF	D100x12	d32-Z10	10	5	100	12	25	32	16			
VRDF	D125x12	d40-Z12	12	6	125	12	35	40	16			
VRDF	D80x14	d27-Z08	8	4	80	14	17	27	18			
VRDF	D100x14	d32-Z10	10	5	100	14	25	32	18			
VRDF	D125x14	d40-Z12	12	6	125	14	35	40	18			
VRDF	D80x16	d27-Z06	6	3	80	16	17	27	20	 CC.. 1204	 VRT 10 M4,5x12	 T20
VRDF	D100x16	d32-Z08	8	4	100	16	25	32	20			
VRDF	D125x16	d40-Z10	10	5	125	16	35	40	20			
VRDF	D80x18	d27-Z06	6	3	80	18	17	27	22			
VRDF	D100x18	d32-Z08	8	4	100	18	25	32	22			
VRDF	D125x18	d40-Z10	10	5	125	18	35	40	22			
VRDF	D80x20	d27-Z06	6	3	80	20	17	27	24			
VRDF	D100x20	d32-Z08	8	4	100	20	25	32	24			
VRDF	D125x20	d40-Z10	10	5	125	20	35	40	24			



SPTF

ÜRÜN / PRODUCT

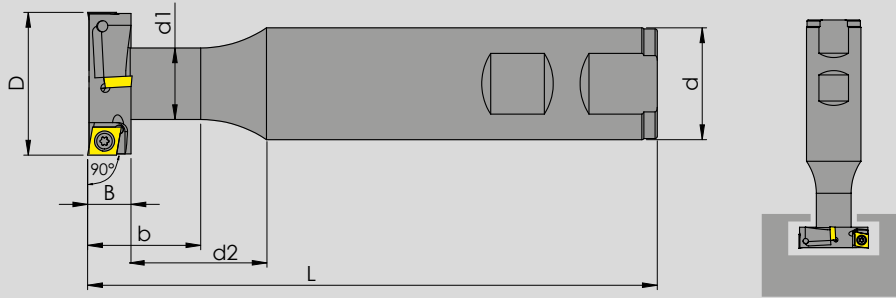

TEKNİK ÇİZİM / TECHNICAL DRAWING



TAKIM KODU ORDERING CODE					TAKIM ÖLÇÜLERİ DIMENSIONS (mm)								KESİCİ UÇ INSERT	YEDEK PARÇALAR / SPARE PARTS	
														BASKI VIDASI SCREW	ANAHTAR TORX KEY
SPTF	D17x8	d16	Z02	L100	Z	Z1	D	B	D	L	D1	D2	CC.. 0602		
SPTF	D20x9	d16	Z04	L100	4	2	20	9	16	100	10	16		VRT 04 M2,5x7	T08
SPTF	D25x11	d20	Z04	L100	4	2	25	11	25	100	13	20			
SPTF	D32x12	d25	Z04	L100	4	1	32	12	25	100	16	25	CC.. 09T3	VRT 06 M3,5x9	T15
SPTF	D35x15	d25	Z04	L100	4	2	35	15	25	100	17	30			
SPTF	D40x17	d32	Z04	L120	4	2	40	17	32	120	19	30	CC.. 1204	VRT 10 M4,5x12	T20
SPTF	D50x22	d32	Z04	L120	4	2	50	22	32	120	25	45			
SPTF	D52x21	d32	Z04	L120	4	2	52	21	32	120	25	45			

ISO

ÜRÜN / PRODUCT

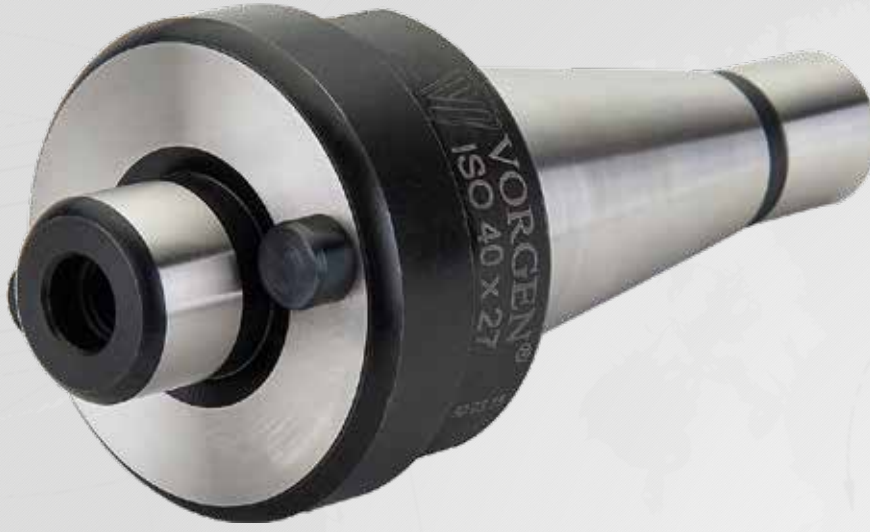

TEKNİK ÇİZİM / TECHNICAL DRAWING

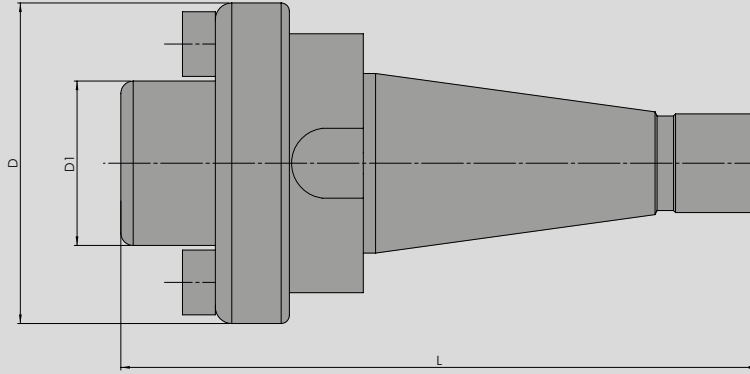

TAKIM KODU ORDERING CODE		TAKIM ÖLÇÜLERİ DIMENSIONS (mm)			YEDEK PARÇALAR / SPARE PARTS	
					BASKI VIDASI SCREW	ANAHTAR ALLEN KEY
		D	d1	L		
ISO	40-Q16	39	16	154	VR08 M8	AA6
ISO	40-Q22	50	22	154	VR09 M10	AA8
ISO	40-Q27	66	27	154	VR11 M12	AA10
ISO	40-Q32	66	32	154	VR10 M16	AA14
ISO	40-Q40	72	40	154	VR12 M20	AA17



YEDEK PARÇALAR

Spare parts

www.vorgen.com

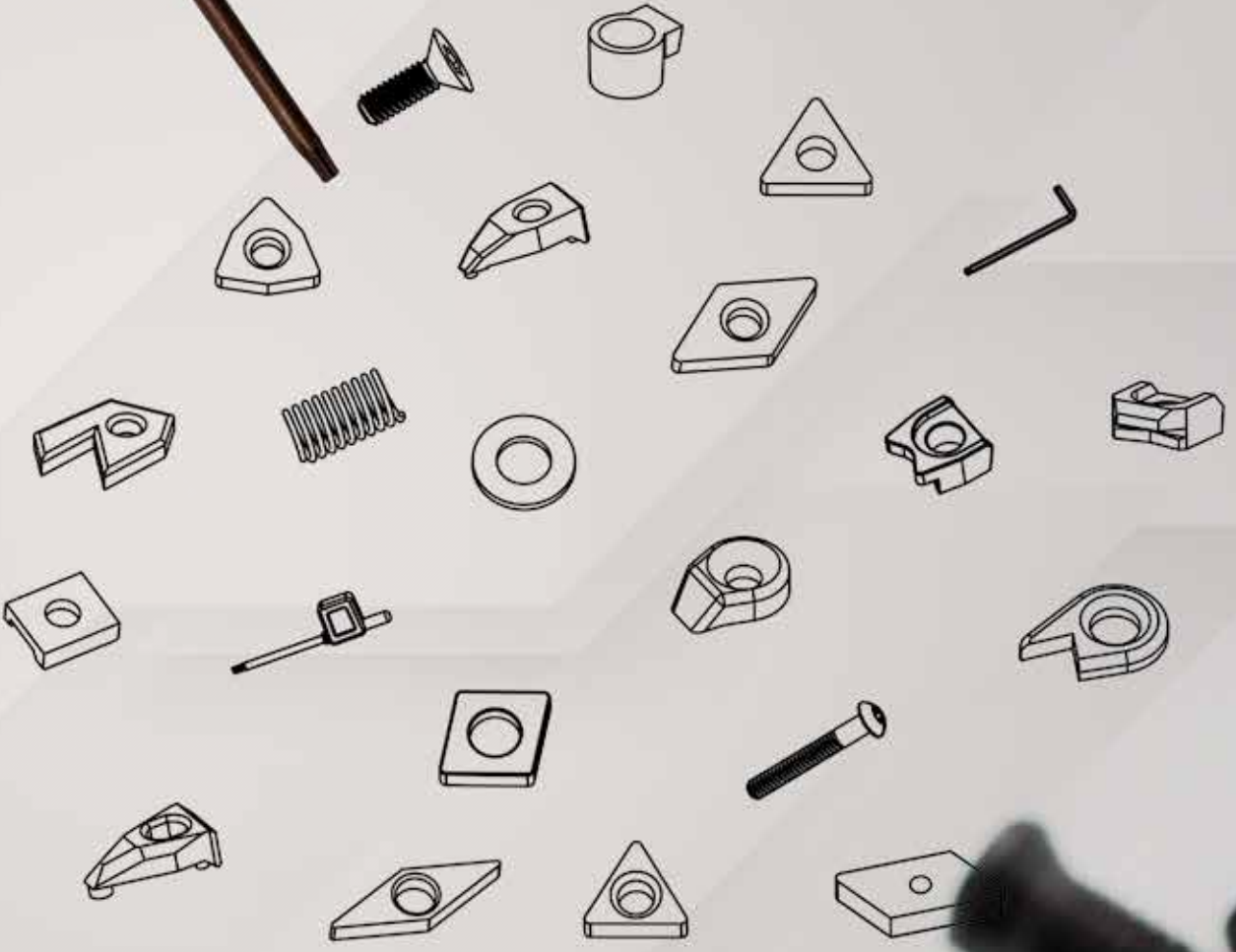





The red power for
the professionals
Profesyoneller için
Kırmızı Güç

BASKI PAPUÇLARI / WEDGE CLAMP

ÜRÜN KODU ORDER CODE	ÜRÜN DETAYI DETAILS PRODUCT	ÜRÜN RESMİ PRODUCT OF PICTURE
VDP 01	D SİSTEM İÇİN DNMG 11, WNMG 06, TNMG 16	
VDP 02	D SİSTEM İÇİN TNMG22, DNMG 15, CNMG 12, SNMG12, WNM 08,	
VDP 03	D SİSTEM İÇİN VNMG 16	
VDP 04	D SİSTEM İÇİN CNMG16, SNMG 15	
VDP 05	D SİSTEM İÇİN CNMG 19, SNG 19	
VMP 01	M SİSTEM İÇİN WNMG 06	
VMP02	M SİSTEM İÇİN WNMG 08	
VMP 03	M SİSTEM İÇİN TNMG 16	
VMP 04	M SİSTEM İÇİN TNMG 22	
VCP 01	C SİSTEM İÇİN KNUX-R (ORJİNAL)	
VCP 02	C SİSTEM İÇİN KNUX-L (ORJİNAL)	
VCP 03	C SİSTEM İÇİN 154.91, IR 16, ER 16, IR 22, ER 22, TPKN 16	
VCP 04	C SİSTEM İÇİN TPKN 22	
VCP 05	C SİSTEM İÇİN KNUX-R	
VCP 06	C SİSTEM İÇİN KNUX-L	
VCP 07	C SİSTEM İÇİN SERAMİK CNGN, SNGM, DNGN	
VKP 01	BKT-R390 İÇİN R390 HRN	
VSP 01	SPKN TAR. İÇİN SPKN SET	

ALTLIKLAR / SHIMS

ÜRÜN KODU ORDER CODE	ÜRÜN DETAYI DETAILS PRODUCT	ÜRÜN RESMİ PRODUCT OF PICTURE
VRTC 16	S SİSTEM İÇİN TCMT 16	
VRTN 16	D SİSTEM İÇİN M SİSTEM İÇİN TNMG 16	
VRTN 22	D SİSTEM İÇİN M SİSTEM İÇİN TNMG 22	
VRTN 2202	S25S M SİSTEM İÇİN TNMG 22	
VRIR 16	VİDA 16 ALTLIK IR 16, ER 16	
VRIR 22	VİDA 22 ALTLIK IR 22, ER 22	
VRCM 09	S SİSTEM İÇİN CCMT 09	
VRCN 12	D SİSTEM İÇİN C SİSTEM İÇİN CNMG 12, CNGN 12	
VRCN 16	D SİSTEM İÇİN CNMG 16	
VRCN 19	D SİSTEM İÇİN CNMG 19	
VRWN 08	D SİSTEM İÇİN M SİSTEM İÇİN WNMG 08	
VRKN 16L	C SİSTEM İÇİN KNUX-L 16	
VRKN 16R	C SİSTEM İÇİN KNUX-R 16	
VRSC 12	S SİSTEM İÇİN SCMT 12	
VRSN 12	D SİSTEM İÇİN C SİSTEM İÇİN SNMG 12, SNMN 12	
VRTP 22	TP 22 TAR. İÇİN TPKN 22	









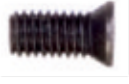

ALTLIKLAR / SHIMS

ÜRÜN KODU ORDER CODE	ÜRÜN DETAYI DETAILS PRODUCT	ÜRÜN RESMİ PRODUCT OF PICTURE
VRSN 15	D SİSTEM İÇİN SNMG 15	
VRSN 19	D SİSTEM İÇİN SNMG 19	
VRDC 11	S SİSTEM İÇİN D SİSTEM İÇİN DNMG 11, DCMT 11	
VRDN 15	D SİSTEM İÇİN DNMG 15	
VRVB 16	S SİSTEM İÇİN D SİSTEM İÇİN VBMT 16, VCMT 16, VNMG 16	

BASKI PAPUÇ VİDALARI / CLAMP SCREW

ÜRÜN KODU ORDER CODE	ÜRÜN DETAYI DETAILS PRODUCT	ÜRÜN RESMİ PRODUCT OF PICTURE
VRV 01-M5	D SİSTEM İÇİN M SİSTEM İÇİN DNMG 11, TNMG 16, WNMG 06	
VRV 02-M6	D SİSTEM İÇİN M SİSTEM İÇİN CNMG 12, TNMG 22, DNMG 15, SNMG 12, TNMG 22, VNMG 16, WNMG 08	
VRV 03-M6	D SİSTEM İÇİN CNMG 19, SNMG 15, SNMG 19, CNMG 16	
VRV 04-M6	C SİSTEM İÇİN KNUX 16	
VRV 05-M8	C SİSTEM İÇİN DNGN, TNGN, SNGN	
VRV 001-M6	TARAMA İÇİN TPKN 16	
VRV 002-M8	TARAMA İÇİN TPKN 22	
VRV 003-M8	TARAMA İÇİN SPKN 12 (SOL)	
VRV 06-M8	KANAL KATERİ İÇİN JD, HTN, KRY, SD S123, ZCC..	

ALTLIK VİDALARI / SHIMS SCREWS

ÜRÜN KODU ORDER CODE	ÜRÜN DETAYI DETAILS PRODUCT	ÜRÜN RESMİ PRODUCT OF PICTURE
VAV 01-M3	C SİSTEM İÇİN KNUX 16	
VAV 02-M5	D SİSTEM İÇİN DNMG 15, SNMG 12, TNMG 22, WNMG 08, CNMG 12	
VAV 03-M4	D SİSTEM İÇİN DNMG 11	
VAV 04-M5	D SİSTEM İÇİN CNMG 16, SNMG 15	
VAV 05-M6	D SİSTEM İÇİN CNMG 19, SNMG 19	
VAV 06-M5.05	S SİSTEM İÇİN VBMT 16, ER 16, IR 16, TCMT 16, CCMT 09, DCMT 11, VCMT 16, BUKSE VİDA 3,5	
VAV 07-M6	S SİSTEM İÇİN ER 22, SCMT 12, BUKSE VİDA 4,5	
VAV 08-M5	M SİSTEM İÇİN TNMG 16, WNMG 06	
VAV 09-M5	M SİSTEM İÇİN S 20, MTUNR 16 İÇİN VİDALI PİM	
VAV 10-M6	M SİSTEM İÇİN WNMG 08, TNMG 22	
VTP 005	TIRTIR İÇİN	

BASKI YAY / SPRING

ÜRÜN KODU ORDER CODE	ÜRÜN DETAYI DETAILS PRODUCT	ÜRÜN RESMİ PRODUCT OF PICTURE
VRY 01	D SİSTEM İÇİN WNMG 16, WNMG 08, TNMG 22, DNMG 15, CNMG 12	
VRY 02	C SİSTEM İÇİN KNUX 16	

YEDEK PARÇALARDA İSKONTO ORANI FARKLIDIR.
YOU HAVE THE DIFFERENT DISCOUNT ON THE SPARE PARTS.

TORX VİDALARI / TORX SCREWS

ÜRÜN KODU ORDER CODE	ÜRÜN DETAYI DETAILS PRODUCT	ÜRÜN RESMİ PRODUCT OF PICTURE
VRT 01-M2x5		
VRT 02-M2,2x5		
VRT 03-M2,5x5		
VRT 04-M2,5x5		
VRT 05-M3x8		
VRT 06-M3,5x9		
VRT 07-M3,5x11		
VRT 08-M3,5x16		
VRT 09-M4x11		
VRT 10-M4,5x12		
VRT 11-M4,5x16		
VRT 12-M6x16		

YEDEK PARÇALARDA İSKONTO ORANI FARKLIDIR.
YOU HAVE THE DIFFERENT DISCOUNT ON THE SPARE PARTS.

KÜRE VİDALARI / BALL SCREW

ÜRÜN KODU ORDER CODE	ÜRÜN DETAYI DETAILS PRODUCT	ÜRÜN RESMİ PRODUCT OF PICTURE
VKV 01-M3		
VKV 02-M4		
VKV 03-M5		
VKV 04-M5		
VKV 05-M6		
VKV 06-M8		

ALYAN ANAHTARLARI / ALLEN KEYS

ÜRÜN KODU ORDER CODE	ÜRÜN DETAYI DETAILS PRODUCT	ÜRÜN RESMİ PRODUCT OF PICTURE
AA4		
AA3		
AA4		
AA5		
AA6		
AA6		

YEDEK PARÇALARDA İSKONTO ORANI FARKLIDIR.
YOU HAVE THE DIFFERENT DISCOUNT ON THE SPARE PARTS.

TORX ANAHTARLARI / TORX KEYS

ÜRÜN KODU ORDER CODE	ÜRÜN DETAYI DETAILS PRODUCT	ÜRÜN RESMİ PRODUCT OF PICTURE
T 06		
T 08		
T 10		
T 15		
T 20		

YEDEK PARÇALARDA İSKONTO ORANI FARKLIDIR.
YOU HAVE THE DIFFERENT DISCOUNT ON THE SPARE PARTS.

The **red** power for
the professionals

Profesyonel

ler için
Kırmızı Güç



 **VORGEN®**



The **red** power for
the professionals
Profesyoneler İin
Kırmızı G



VORGEN[®]



bahıvan
Makina Sanayi ve Ticaret



www.kosgep.gov.tr
25.06.2019 tarihinde
UEL OFSET / KONYA
Sanahteri basılımda:
0.332 342 00 92



Tel: +90 332 **345 09 66**
Tel: +90 332 **345 09 67**
Fax: +90 332 **345 06 42**

Bsan zel Organize San. elik Cad.
No: 43 Karatay / KONYA / TURKEY
www.vorgen.com

info@vorgen.com
export@vorgen.com